

DRAFT

Master Infrastructure Plan

Alameda Point

ALAMEDA, CALIFORNIA

August 8, 2013



Prepared For:



Prepared By:



**Carlson, Barbee
& Gibson, Inc.**

CIVIL ENGINEERS • SURVEYORS • PLANNERS

2633 CAMINO RAMON, SUITE 350 • SAN RAMON, CALIFORNIA 94583 • (925) 866-0322 • www.cbandg.com

ACKNOWLEDGEMENTS

CITY COUNCIL

Marie Gilmore - Mayor
Marilyn Ezzy Ashcraft - Vice Mayor
Stewart Chen
Tony Daysog
Lena Tam

PLANNING BOARD

Dania Alvernaz-Morrone
Stanley Tang
David Burton
Mike Henneberry
John Knox White
Kristoffer Köster
Lorre Zuppan

CITY OF ALAMEDA

Robert Haun - Public Works Director
Ed Sommerauer - City Engineer
Jennifer Ott - Chief Operating Officer - Alameda Point
Andrew Thomas - City Planner

PREPARED BY:

Carlson, Barbee & Gibson, Inc.

In Association with:

Balance Hydrologics, Inc.
ENGEO, Inc.
Power Systems Design
Coleman Engineering

TABLE OF CONTENTS

I.	INTRODUCTION AND PURPOSE	1
A.	Purpose.....	1
B.	Project Description and Land Use Program	1
C.	Development and Reuse Areas.....	4
D.	Existing Infrastructure.....	6
E.	Backbone Infrastructure Framework.....	6
F.	Backbone Infrastructure Phasing	6
G.	Master Infrastructure Plan Flexibility.....	8
H.	Sustainability Considerations	8
I.	Backbone Infrastructure Costs & Value Engineering.....	8
J.	Project Datum	8
II.	DEMOLITION AND PRESERVATION	10
A.	Demolition.....	10
B.	Preservation.....	10
C.	Environmental Remediation	11
III.	FLOOD PROTECTION AND SITE GRADING.....	17
A.	Sea Level Rise and Adaptive Management.....	17
B.	Geotechnical Conditions.....	31
C.	Value Engineering Opportunities	40
IV.	STREET SYSTEM	41
A.	Existing On-Site Street System	41
B.	Proposed On-Site Street System	41
C.	Proposed Transit System	68
D.	Proposed Off-Site Street Improvements	71
V.	PARKS AND OPEN SPACE.....	74
A.	Existing Parks and Community Facilities	74
B.	City of Alameda’s Urban Greening Plan and Parks Improvement Assessment	76
C.	Proposed Open Space Framework	76
VI.	WASTEWATER	80
A.	Existing Wastewater System	80
B.	Proposed Wastewater System	84
VII.	STORMWATER SYSTEM.....	90
A.	Topography and Precipitation	90
B.	Impervious and Development Areas	90
C.	Soil Characteristics and Groundwater	90
D.	Tidal Characteristics.....	91
E.	Existing Stormwater Management System.....	91
F.	Proposed Stormwater Management System.....	95

VIII.	POTABLE WATER	112
A.	Existing Potable Water System	112
B.	Proposed Potable Water System	113
C.	Value Engineering Opportunities	116
IX.	RECYCLED WATER.....	118
A.	Existing Recycled Water System	118
B.	Proposed Recycled Water System.....	118
C.	Value Engineering Opportunities	121
X.	DRY UTILITIES.....	122
A.	Electric System	122
B.	Natural Gas System	128
C.	Telecommunications and Cable Television	130
D.	Street Light System.....	131
XI.	SUSTAINABILITY CONSIDERATIONS.....	132
XII.	PHASING AND IMPLEMENTATION	134
A.	Principles of Phasing and Implementation.....	134
B.	Funding and Financing Approach.....	137
C.	Phase 1 - Scenario 1	137
D.	Phase 1 - Scenario 2	140
E.	Phase 1 - Scenario 3	143
F.	Sub-Phases	145
G.	Permitting	145
XIII.	MIP FLEXIBILITY	149
A.	Low Density	149
B.	High Density	150
C.	Implementation	150
XIV.	CONSTRUCTION COSTS.....	155
A.	Backbone Infrastructure Costs.....	155
B.	Value Engineering and Potential Cost Reductions	157

LIST OF FIGURES

Figure 1 - Site Location	2
Figure 2 - Sub-Districts	3
Figure 3 - Reuse & Development Areas	5
Figure 4 - Backbone Framework.....	7
Figure 5 - Existing Buildings to be Preserved	12
Figure 6 - IR Site Status as of April 2013.....	13
Figure 7 - Marsh Crust Ordinance.....	14
Figure 8 - Utilidor Locations.....	15
Figure 9 - Utilidor Concept	16
Figure 10 - Existing Areas of Inundation.....	18
Figure 11 - Initial Flood Protection	23
Figure 12 - Adapted Flood Protection.....	26
Figure 13 - Flood Protection Adaptive Measures.....	27
Figure 14 - Flood Protection Adaptive Measures.....	28
Figure 15 - Fill Areas Map	30
Figure 16 - Northern Shoreline Cross-Section Locations.....	32
Figure 17 - Northern Shoreline Zone of Potential Deformation.....	34
Figure 18 - Liquefiable Soils.....	36
Figure 19 - Young Bay Mud Deposits.....	38
Figure 20 - Existing Street Framework.....	42
Figure 21 - Proposed Street Framework.....	43
Figure 22 - Proposed Street Classifications	45
Figure 23 - Conceptual Street Sections - Development Areas.....	46
Figure 24 - Conceptual Street Sections - Reuse Areas	57
Figure 25 - Proposed Bike Facilities.....	66
Figure 26 - Proposed Truck Route	67
Figure 27 - Proposed Transit Systems.....	69
Figure 28 - Off-Site Street Improvements	72
Figure 29 - Existing Park and Community Facilities	75
Figure 30 - Public Trust.....	77
Figure 31 - Proposed Open Space.....	78
Figure 32 - Existing Sanitary Sewer (On-Site)	81
Figure 33 - Existing Sanitary Sewer (Off-Site Transmission).....	83
Figure 34 - Proposed Sanitary Sewer in Development Areas.....	86
Figure 35 - Proposed Sanitary Sewer Reuse Areas Initial Construction	87
Figure 36 - Proposed Sanitary Sewer Ultimate System.....	88
Figure 37 - Existing Storm Drain & Outfalls	93
Figure 38 - Existing Watersheds	94
Figure 39 - Proposed Storm Drain	96
Figure 40 - Proposed Storm Drain Ultimate System	98
Figure 41 - Proposed Storm Drain Reuse Areas Initial Construction.....	99
Figure 42 - Conceptual Two-Tier Multi-Purpose Basin	103
Figure 43 - Conceptual Basin / Outfall	105
Figure 44 - Proposed Storm Drain Watersheds	106
Figure 45 - Existing Water System	114
Figure 46 - Proposed Ultimate Water System	117

Figure 47 - EBMUD East Bayshore Recycled Water Project119
Figure 48 - Proposed Recycle Water120
Figure 49 - Existing Electrical System123
Figure 50 - Cartwright Substation126
Figure 51 - Proposed Ultimate Joint Trench127
Figure 52 - Existing Natural Gas Lines.....129
Figure 53 - Phasing Plan Scenario 1.....138
Figure 54 - Phasing Plan Scenario 2.....141
Figure 55 - Phasing Plan Scenario 3.....144
Figure 56 - Phase 1A “South”146
Figure 57 - Phase 1A “North”147
Figure 58 - Proposed Ultimate Sewer System (High Density).....151
Figure 59 - Proposed Ultimate Sewer System (Low Density)152
Figure 60 - Proposed Ultimate Water System (High Density)153
Figure 61 - Proposed Ultimate Water System (Low Density)154
Figure 62 - Estimate Phasing158

LIST OF TABLES

Table 1 - Land Use Program (1996 Community Reuse Plan)4
Table 2 - Alameda Point Vertical Datum Summary.....9
Table 3 - Wind Conditions.....19
Table 4 - Site Grading Design Criteria.....24
Table 5 - Wastewater Flow Generation Factors84
Table 6 - Tidal Datum Elevations for Alameda Point91
Table 7 - Preliminary Multi-Purpose Basin & Pump Sizes with Adaptive Measures102
Table 8 - Potable Water Flow Generation Factors.....113
Table 9 - Estimated Potable Water Demand (Buildout)113
Table 10 - Estimated Potable Water Demand Per Sub-District (Buildout)115
Table 11 - Estimated Electric Demand (Buildout)124
Table 12 - Estimated Gas Demand (Buildout).....128
Table 13 - Low and High Density Alternatives Relative to the Reuse Plan149
Table 14 - Backbone Infrastructure Construction Costs.....155

APPENDICES

- A) GEOTECHNICAL CONSTRAINTS MEMORANDUM (ENGEIO, INC.)**
- B) DETAILED UTILITY SCHEMATIC PLAN**
- C) WASTEWATER FLOW CALCULATIONS**
- D) SANITARY SEWER FLOW ESTIMATES AND MODELING (RMC)**
- E) STORMWATER PROTOTYPICAL WATERSHED MODEL**
- F) POTABLE WATER SYSTEM MODEL (FILES INCLUDED ON SEPARATE CD)**
- G) DETAILED BACKBONE INFRASTRUCTURE CONSTRUCTION COST ESTIMATE SUMMARY**

I. INTRODUCTION AND PURPOSE

A. Purpose

The Master Infrastructure Plan (MIP) establishes the requirements and standards for the backbone infrastructure to support the redevelopment and reuse of Alameda Point, the Project Site. The backbone infrastructure is the major framework of streets and utilities. Additional internal streets and local utility systems, “in-tract” and “on-site” improvements, will connect to and be supported by the backbone infrastructure. The MIP describes the required replacement and/or rehabilitation of existing backbone utility systems, streets and open spaces at the Project Site. The MIP includes information regarding the stormwater, wastewater, potable water, recycled water, electrical, natural gas and telecommunication utility systems. Additionally, the MIP describes a “complete streets” transportation network to support a variety of modes of transportation.

The MIP also outlines the required corrective geotechnical and flood protection improvements for the Project Site. Corrective geotechnical measures are necessary to provide seismic stability of the Project’s shorelines and underlying soils. Flood protection improvements including site grading, perimeter improvements and establishing future adaptive measures are necessary to protect the site from the 100-year tidal event and provide long-term protection for sea-level rise due to climate change.

The MIP summarizes the parks and open space system within the Project Site based on the detailed assessment included in the City of Alameda’s Urban Greening Plan. Additionally, the MIP summarizes the proposed off-site street improvements and transit systems that are proposed as part of the Project. This summary is largely based on the City of Alameda’s Regional Transit Access Study and traffic studies prepared as part of the Environmental Impact Report (EIR). The summary information regarding these elements of the Project is consolidated in the MIP to provide a comprehensive overview of the major improvements and framework at the Project Site. The detailed analysis of these elements is provided in the other referenced reports and plans.

B. Project Description and Land Use Program

Alameda Point is the former Naval Air Station Alameda located west of Main Street at the northwest end of the City of Alameda, California. The Project Site includes approximately 878 acres of unsubmerged lands and 1,229 acres of submerged lands, a total of 2,107 acres. It is bound by the Oakland-Alameda Estuary to the north, Main Street to the east, and the San Francisco Bay to the south and west. Certain portions of the Project Site are bound to the south and west by a 624-acre area including former airplane runways that are intended to be transferred from the Navy to the United States Department of Veteran Affairs (VA Property) and are not a part of the Project Site. Conservatively, the infrastructure demands associated with the proposed development within the VA Property are included in the MIP. Currently, the proposed development within the VA Property includes the construction of a VA Outpatient Clinic, Columbarium Cemetery and associated improvements. See Figure 1, Project Site Location.

The Land Use Program analyzed by the MIP is generally based upon the NAS Alameda Community Reuse Plan (Reuse Plan), prepared in 1996. The Project is designed to accommodate a mix of land uses, including a combination of newly constructed buildings and adaptive reuse of existing buildings. A Zoning Ordinance Amendment is concurrently being processed by the City of Alameda. This document establishes and organizes the Project Site into various Sub-Districts, Enterprise, Adaptive Reuse, Waterfront Town Center, Main Street Neighborhood and Open Space generally consistent with the Zoning Ordinance Amendment. Table 1 outlines the proposed Land Use Program for each Sub-District. See Figure 2, Alameda Point Sub-Districts.

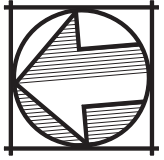

**FIGURE 1
SITE LOCATION**

**ALAMEDA POINT
MASTER INFRASTRUCTURE PLAN**
 CITY OF ALAMEDA ALAMEDA COUNTY CALIFORNIA
 DATE: JUNE, 2013 SCALE: 1" = 4,000'
Carlson, Barbee, & Gibson, Inc.

G:\1087-10\ACAD-10\EXHIBITS\BASE CASE ALT - FIGURES\B_1_SITE LOCATION.DWG

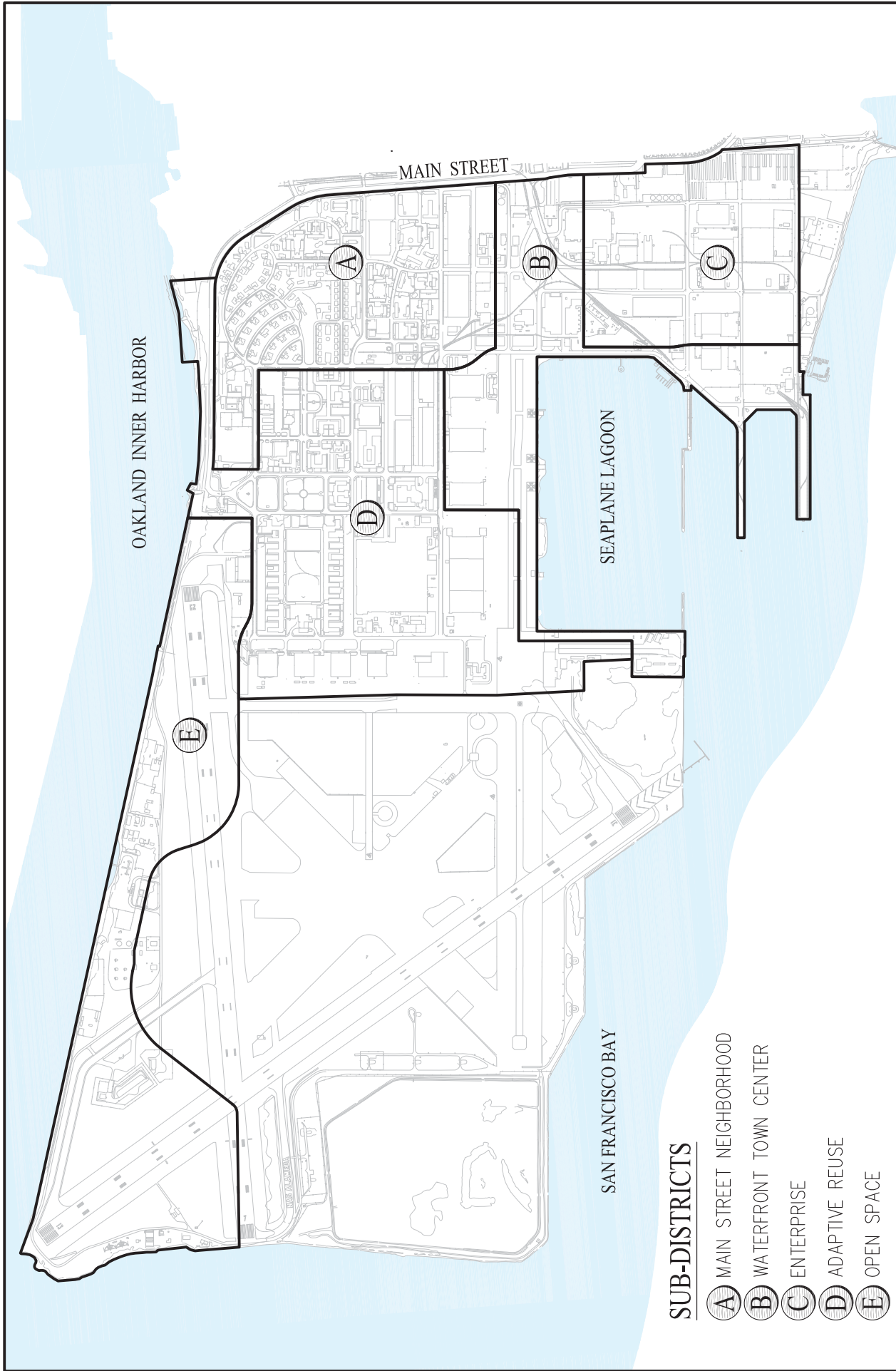

SUB-DISTRICTS

- A** MAIN STREET NEIGHBORHOOD
- B** WATERFRONT TOWN CENTER
- C** ENTERPRISE
- D** ADAPTIVE REUSE
- E** OPEN SPACE

**ALAMEDA POINT
MASTER INFRASTRUCTURE PLAN**
 CITY OF ALAMEDA ALAMEDA COUNTY CALIFORNIA
 DATE: JUNE, 2013 SCALE: 1" = 1,500'
Carlson, Barbee, & Gibson, Inc.

**FIGURE 2
SUB-DISTRICTS**

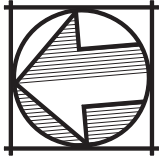

G:\1087-10\ACAD-10\EXHIBITS\BASE CASE ALT - FIGURES\B_2_SUB-DISTRICTS.DWG

Table 1 - Land Use Program (1996 Community Reuse Plan)

Land Use	Sub-District					Total
	A	B	C	D	E	
Residential (Units)	760	490	-	175	-	1,425
Commercial						
Office / Manufacturing (SF)	-	791,000	1,535,000	2,362,000	-	4,688,000
Retail and Service (SF)	100,000	410,000	100,000	202,000	-	812,000
Subtotal Commercial	100,000	1,201,000	1,635,000	2,564,000	-	5,500,000
Open Space (Acres)	3	35	24	33	214	309

The Enterprise uses include a mix of retail, commercial recreation, commercial office, business park, industrial, and institutional. The Main Street Neighborhood uses include single family detached and multi-family housing units. The Main Street Neighborhood uses also include the 200 existing supportive housing units managed by the Alameda Point Collaborative, Building Futures for Women and Children, and Operation Dignity (Supportive Housing Providers). The MIP assumes these supportive housing units will be relocated to a new facility located in the northeast corner of the Main Street Neighborhood Sub-District. The Waterfront Town Center Sub-District will include transit-oriented design standards to create a mixed-use, transit-oriented, and walkable waterfront. The MIP assumes the Project will include the construction of a 530 slip marina in the Seaplane Lagoon. The Open Space uses include parks, open space, waterfront promenade, a continuous Bay Trail, historic open spaces and parade grounds, neighborhood parks and recreation facilities, such as on-site parks, walking and bike trails, and on-street sidewalks and bike paths.

C. Development and Reuse Areas

For purposes of the infrastructure planning and MIP, it is important to distinguish the Project Site as two main areas: Development Areas and Reuse Areas. The infrastructure needs and requirements for each of these areas are unique. Accordingly, the MIP describes the planned backbone infrastructure specific for each of the areas.

The Development Areas are those areas within the Project Site that are anticipated to consist of all new construction. The existing structures, streets and utilities within these areas will be demolished. New infrastructure will be installed to support the proposed uses within the Development Areas. It is anticipated that development within the Development Areas will occur in cohesive areas and will be orderly implemented. The Development Areas encompass the majority of the Enterprise, Main Street Neighborhood and Waterfront Town Center Sub-Districts.

The Reuse Areas include the historic areas within the Project Site that are largely intended to be preserved and adaptively reused to the extent feasible. The preservation of the historic buildings and landscapes require specific infrastructure considerations and requirements. It is likely that development within Reuse Areas will be fragmented. The MIP presents the infrastructure systems and flood protections measures required for the Reuse Areas. A sequenced implementation of rehabilitation and replacement of the existing street and utility systems is discussed in the MIP as well.

See Figure 3 depicting the limits of the Reuse and Development Areas assumed for the MIP, excluding new open space and park areas.

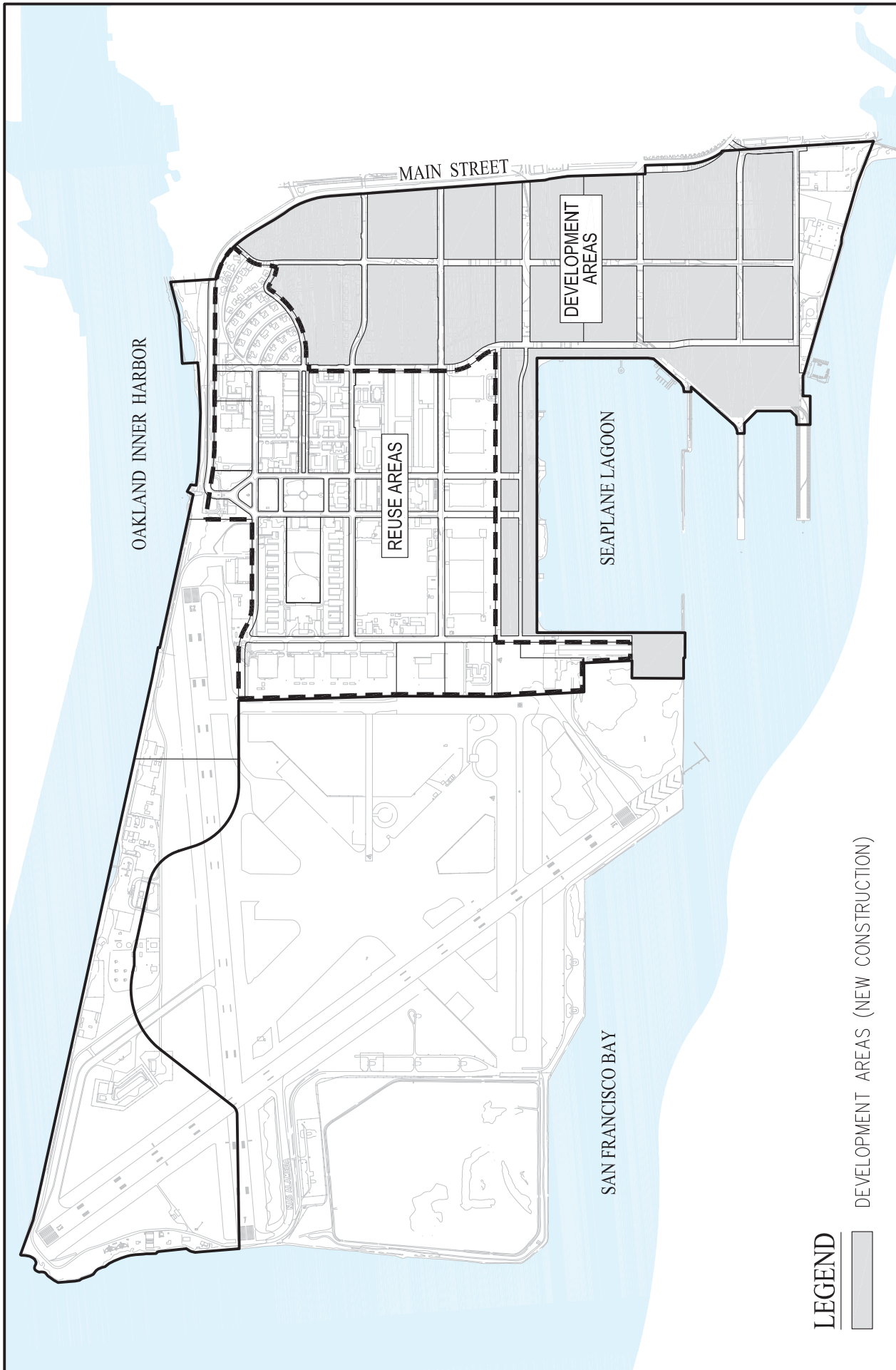

LEGEND

DEVELOPMENT AREAS (NEW CONSTRUCTION)

**ALAMEDA POINT
MASTER INFRASTRUCTURE PLAN**
 CITY OF ALAMEDA ALAMEDA COUNTY CALIFORNIA
 DATE: JUNE, 2013 SCALE: 1" = 1,500'
Carlson, Barbee, & Gibson, Inc.

**FIGURE 3
REUSE & DEVELOPMENT AREAS**

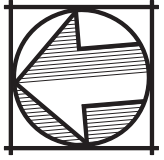

D. Existing Infrastructure

The existing infrastructure within Alameda Point was installed by the Navy. The majority of the infrastructure was constructed over 70 years ago, and is beyond its service life. The Navy installed, maintained and improved the existing infrastructure on an as-needed basis. The active existing utility systems include wastewater, stormwater, potable water, electrical, natural gas and telecommunications. The inactive existing utility systems include industrial waste, steam and fuel. Many of the existing utility pipelines and associated facilities are located outside of the existing streets, within future development areas. The active existing infrastructure is currently operable and services the existing tenants at Alameda Point. However, it is deteriorated and generally unreliable. Additionally, the existing infrastructure does not meet current codes or standards.

There are numerous issues with the existing infrastructure. It cannot support the redevelopment of Alameda Point without rehabilitation or replacement. Some of the documented major issues with the existing systems include:

- The existing stormwater system allows high tide waters to enter the system and flood low lying areas within the Project Site.
- The sanitary sewer system allows infiltration and inflow into the downstream transmission system during wet weather conditions.
- The water system has been subject to breaks and repairs that are costly and sometimes require that tenants be without water service for up to several days.
- The telecommunications systems are unreliable and existing tenants have experienced breaks in service for multiple days.
- The natural gas system does not provide service to many areas within the site.
- The sidewalks range from good to poor condition throughout the site and many locations do not meet accessibility standards and require replacement.

E. Backbone Infrastructure Framework

The MIP establishes a program of backbone infrastructure improvements for Alameda Point. The framework of these backbone improvements is generally based on the grid of streets that comprise the existing street system within the Project Site and the adjoining areas to the east. The framework creates development blocks that range in size from approximately 1.5 acres in the Waterfront Town Center District to nearly 30 acres in the Adaptive Reuse Sub-District. The backbone framework defines corridors necessary to be reserved for infrastructure improvements and ensure the successful phased implementation of the MIP. See Figure 4, Backbone Framework.

Additional internal streets, local utility systems and neighborhood parks, or “in-tract” and “on-site” improvements, will connect to and be supported by the backbone infrastructure. This internal / local infrastructure is dependent on the specific site plan for each development block and will be defined concurrent with the internal developments. The MIP presents general standards for the internal / local infrastructure but does not establish specific locations or provide schematics for this level of infrastructure.

F. Backbone Infrastructure Phasing

The MIP divides the Project Site into three major phases of development as a means of analyzing and illustrating the implementation of the infrastructure improvements. These major phases correlate to the Sub-Districts established by the Zoning Ordinance Amendment. Ultimately, each major phase will be further separated into smaller sub-phases as development occurs. The MIP discusses three “Phase 1” scenarios and presents the necessary infrastructure to be installed in each respective phase scenario. The intent of presenting these multiple scenarios is to outline the infrastructure requirements and coordination associated with the different potential scenarios and to inform future decisions regarding how to phase and develop the Project Site.

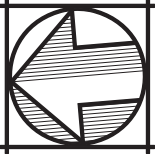
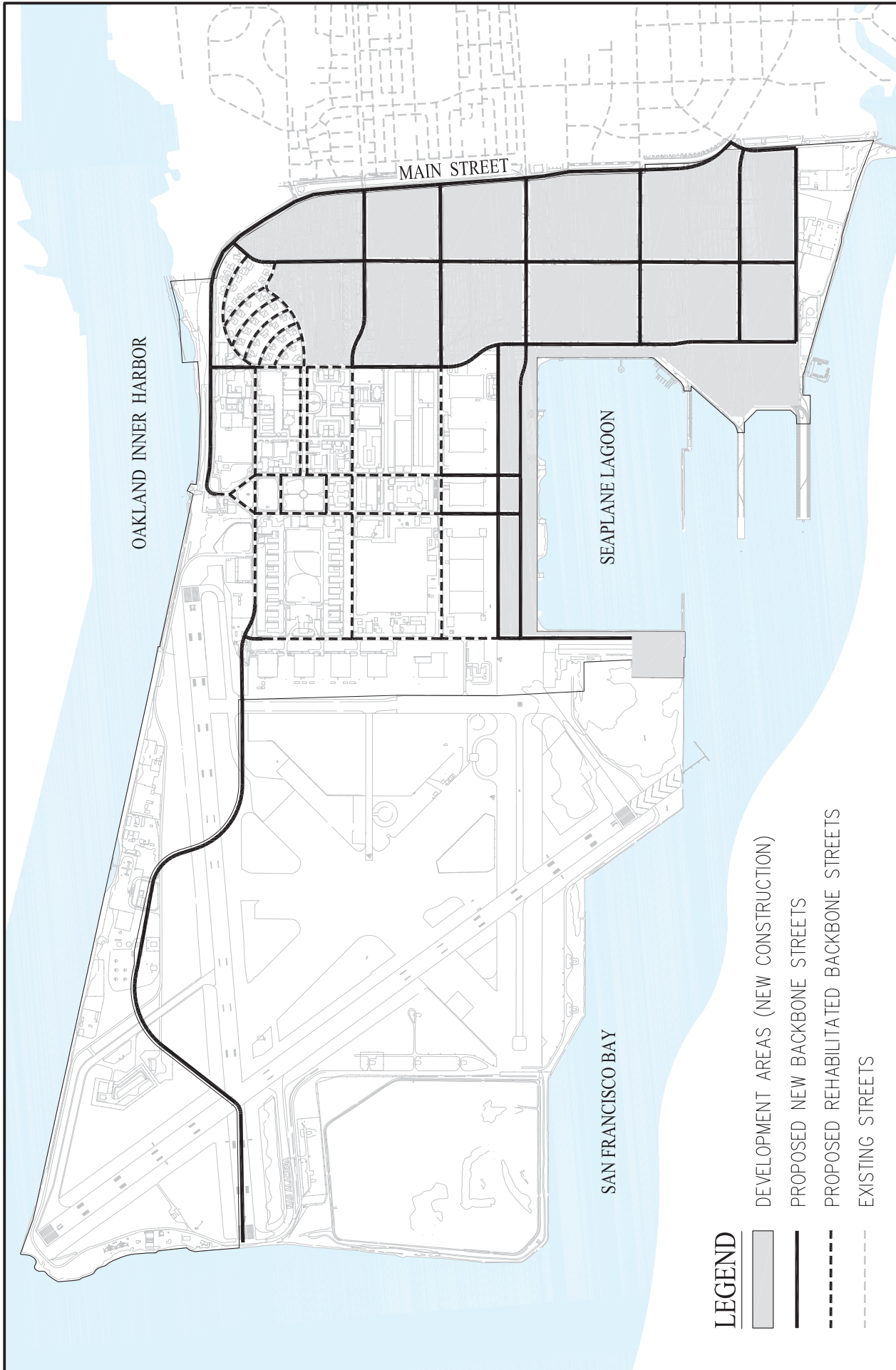

FIGURE 4 BACKBONE FRAMEWORK

**ALAMEDA POINT
MASTER INFRASTRUCTURE PLAN**
CITY OF ALAMEDA ALAMEDA COUNTY CALIFORNIA
DATE: JUNE, 2013 SCALE: 1" = 1,500'
Carlson, Barbee, & Gibson, Inc.

G:\1087-10\ACAD-10\EXHIBITS\BASE CASE ALT - FIGURES\B_4_BACKBONE FRAMEWORK.DWG

Each phase of infrastructure will provide corrective geotechnical measures, flood protection improvements and either new or rehabilitated street and utility systems required to support and serve the associated areas within that subject phase. The new infrastructure constructed with each phase will connect to reliable existing infrastructure systems as close to the proximity of each phase as possible. In most cases, permanent or temporary connections to the new systems will be required to maintain service to existing land uses to remain during each phase. Any connection to unreliable existing infrastructure systems will need to provide for the appropriate measures to protect the integrity of the new systems.

G. Master Infrastructure Plan Flexibility

Adjustments to the Land Use Program due to a change in economic conditions, market factors or other unanticipated change to the development concept may occur throughout the implementation of the MIP and redevelopment of Alameda Point. The MIP contemplates potential land use adjustments in the MIP Flexibility sections of the document.

In particular, the MIP analyzes “High Density” and “Low Density” Project Alternatives that are presented in the EIR and presents the components of infrastructure that would need to be adjusted in each alternative. The reductions and additions to the infrastructure systems associated with these Project Alternatives are presented in the Section XIII– MIP Flexibility.

H. Sustainability Considerations

The Reuse Plan established the vision for the redevelopment of Alameda Point as a sustainable development promoting conservation of natural resources, reduction in energy consumption, water usage, greenhouse gases and solid waste generation. The MIP presents the components of green infrastructure and sustainable elements that can realistically be integrated with the major backbone infrastructure systems supporting the redevelopment of Alameda Point. As sustainability technologies continuously evolve, it is expected that Alameda Point infrastructure planning will evolve over time as well and implement sustainable components, where feasible.

I. Backbone Infrastructure Costs & Value Engineering

The backbone infrastructure for Alameda Point described in the MIP is estimated to cost approximately \$550 to \$575 million. The backbone infrastructure will be implemented in phases. In the Phasing and Implementation Section XII, the MIP presents two initial Sub-Phase 1A scenarios, one that establishes 23.5 acres of developable area within the Main Street Neighborhood Sub-District and another that establishes 55 acres of Developable Area with the Enterprise Sub-District. The backbone infrastructure costs are estimated at \$40 million and \$67.5 million for each of these initial Sub-Phase 1A scenarios, respectively.

The MIP also presents value engineering opportunities for components of the backbone infrastructure that could reduce the total cost of the backbone infrastructure by approximately \$21.5 million.

J. Project Datum

The elevations presented in this document are based on the City of Alameda Datum. Table 2 provides conversions from the City of Alameda Datum to other published datum.

Table 2 - Alameda Point Vertical Datum Summary

NGVD 29	NAVD 88	City of Alameda	NAS
0.00 Feet	2.70 Feet	-3.41 Feet	104.23 Feet

The difference between the North American Vertical Datum, 1988 (NAVD 88) and the National Geodetic Vertical Datum, 1929 (NGVD 29), based upon the NGS data sheet for PIC HT0880, a brass disc stamped “Main ATL 1947” at the intersection of Main Street and Atlantic Avenue in the City of Alameda, is 2.70 feet. To obtain NAVD 88 elevations, add 2.70 feet to NGVD 29 elevations.

$$\text{NAVD 88} = \text{NGVD 29} + 2.70 \text{ feet}$$

The difference between NGVD 29 and the City of Alameda vertical datum, based upon the “City of Alameda Tide and Datum Chart from U.S.C.&G.S. Jan 1943” is negative 3.41 feet. To obtain City of Alameda elevation, subtract 3.41 feet from NGVD 29 elevations.

$$\text{City of Alameda} = \text{NGVD} - 3.41 \text{ feet}$$

The difference between NGVD 29 and the Naval Air Station (NAS) datum, is 104.23 feet. To obtain NAS elevations, add 104.23 feet to NGVD 29 elevations.

$$\text{NAS} = \text{NGVD 29} + 104.23 \text{ feet}$$

II. DEMOLITION AND PRESERVATION

A. Demolition

The existing buildings and infrastructure within the Development Areas will be deconstructed and demolished. This includes non-historic buildings, buildings not intended for Adaptive Reuse, existing utility systems, existing street improvements, and landscape elements not to be preserved with the proposed project.

The existing buildings to be deconstructed and demolished were formerly a variety of military uses and supporting purposes. These buildings shall be deconstructed to maximize the reuse or recycling of materials, as feasible, consistent with the City of Alameda goal to divert 75% of waste from landfills. The deconstruction of existing buildings will include the abatement of hazardous materials including asbestos materials, lead based paints and materials, and other materials that may be identified as hazardous. The abatement of hazardous materials may limit the amount of materials available for reuse or recycling.

The existing utility systems to be demolished will either be abandoned in place or removed and disposed of. Generally, the existing utility facilities within the proposed rights of ways of the backbone streets will be removed and disposed of. This is expected in order to eliminate conflicts with the proposed new utility systems. The portions of existing utility systems within development blocks may either be abandoned in place or removed and disposed of, as determined by the City based on the development needs within each specific block and potential maintenance or operational impacts. The method of abandonment in place of existing utilities shall be provided by a geotechnical engineer and likely will include slurry fill in larger pipelines and removal of boxes, manholes and other structures.

The existing street improvements to be demolished shall be recycled and reused on-site to the maximum extent feasible. A concrete and asphalt crushing operation and program will be established to process existing materials from building foundations, street sub-grade, street pavement, sidewalks and pathways. The location of the crushing operation and associated stockpiles will need to be approved by the City of Alameda to ensure impacts to existing residents and businesses are minimized. The recycled concrete and asphalt materials shall be processed to achieve Caltrans specifications for recycled materials. These materials are anticipated to be reused on-site as proposed building foundation slab base material, street sub-grade material and utility trench backfill material.

The existing landscape elements to be demolished, including trees and plants, will be cleared and removed. The materials generated from this process shall be composted for on-site uses such as erosion control and proposed landscaping mulch areas.

B. Preservation

Alameda Point includes buildings, objects, structures and landscaped areas that have historical significance. These historical elements are associated with the military legacy of NAS Alameda and have been designated as the National Registered NAS Alameda Historic District and as a City of Alameda Local Historical Monument. The historical elements are generally located within the Adaptive Reuse, Waterfront Town Center and Main Street Neighborhood Sub-Districts. The majority of the existing structures within the Adaptive Reuse Sub-District and the Big White houses within the Main Street Neighborhood Sub-District are currently anticipated to be preserved. It is assumed that the majority of the landscape areas within these areas will also be preserved. This includes the parade grounds near the Main Gate.

The existing utility systems and street improvements within the historic areas will remain operable and will be rehabilitated and replaced, through an incremental approach. The existing elevations of the street improvements will be preserved in order to maintain the historic street alignment, streetscape and appearance of these areas.

See Figure 5 depicting the existing structures assumed by the MIP to be preserved.

C. Environmental Remediation

The Base Realignment and Closure (BRAC) program manages disposal of excess military real estate. This may involve base closure, environmental cleanup, and property transfer to other federal agencies or communities for reuse. NAS Alameda is a former Navy base and therefore the Department of the Navy is responsible for cleanup and restoration of the Project Site with oversight from federal and state regulators. The Navy has been conducting environmental investigations and cleanup efforts at Alameda Point both before and since the military operations were terminated at NAS Alameda in 1997. The regulatory agencies with oversight of these cleanup efforts include the U.S. Environmental Protection Agency (EPA), State of California Department of Toxic Substances Control and the San Francisco Regional Water Quality Control Board.

Alameda Point is divided into multiple cleanup Operable Units and Installation Restoration (IR) sites. There are 34 IR Sites within Alameda Point, all in various states of investigation or cleanup. The Navy has on-going remediation efforts within the Project Site. The purpose of these cleanup activities is to protect human health and the environment from contamination resulting from past military activities. See Figure 6 depicting the status of the various IR Sites as of 2013.

Additionally, the eastern portions of Alameda Point are underlain with a layer of sediment that was deposited from the late 1800's to the 1920's which was contaminated with semi-volatile organic compounds. This layer is referred to as the Marsh Crust. The City of Alameda has adopted a Marsh Crust Ordinance that requires an excavation permit for excavations into the Marsh Crust to ensure that proper measures are implemented to protect workers from contaminated materials and to require proper disposal of contaminated materials that are encountered. The areas and associated depths of excavations that require an excavation permit in order to comply with the Marsh Crust Ordinance are depicted on Figure 7.

To address the on-going protection of the human health and the environment through the construction of improvements at Alameda Point, a Site Management Plan (SMP) will be prepared for the Project Site. The SMP will provide guidelines that ensure that development activities at the Project Site will be conducted in a manner to protect the health and safety of workers, residents, visitors, and the environment.

In the case that utility construction is required through areas that have active remediation on-going that has yet to be concluded and that may pose an unacceptable health risk to workers managing and maintaining the utility, the utility will be installed within an utilidor. The utilidor is a facility that will provide protection of the utility workers from surrounding contaminants and preclude the migration of these contaminants into the utility trench. This will also protect the workers from encountering contaminants during future maintenance activities in these specific areas. At this time, the locations where the utilidors may be necessary include utilities crossing Operable Units 2B and 2C. See Figure 8 and Figure 9 depicting the potential locations where utilidors may be required and a conceptual detail for the utilidor.

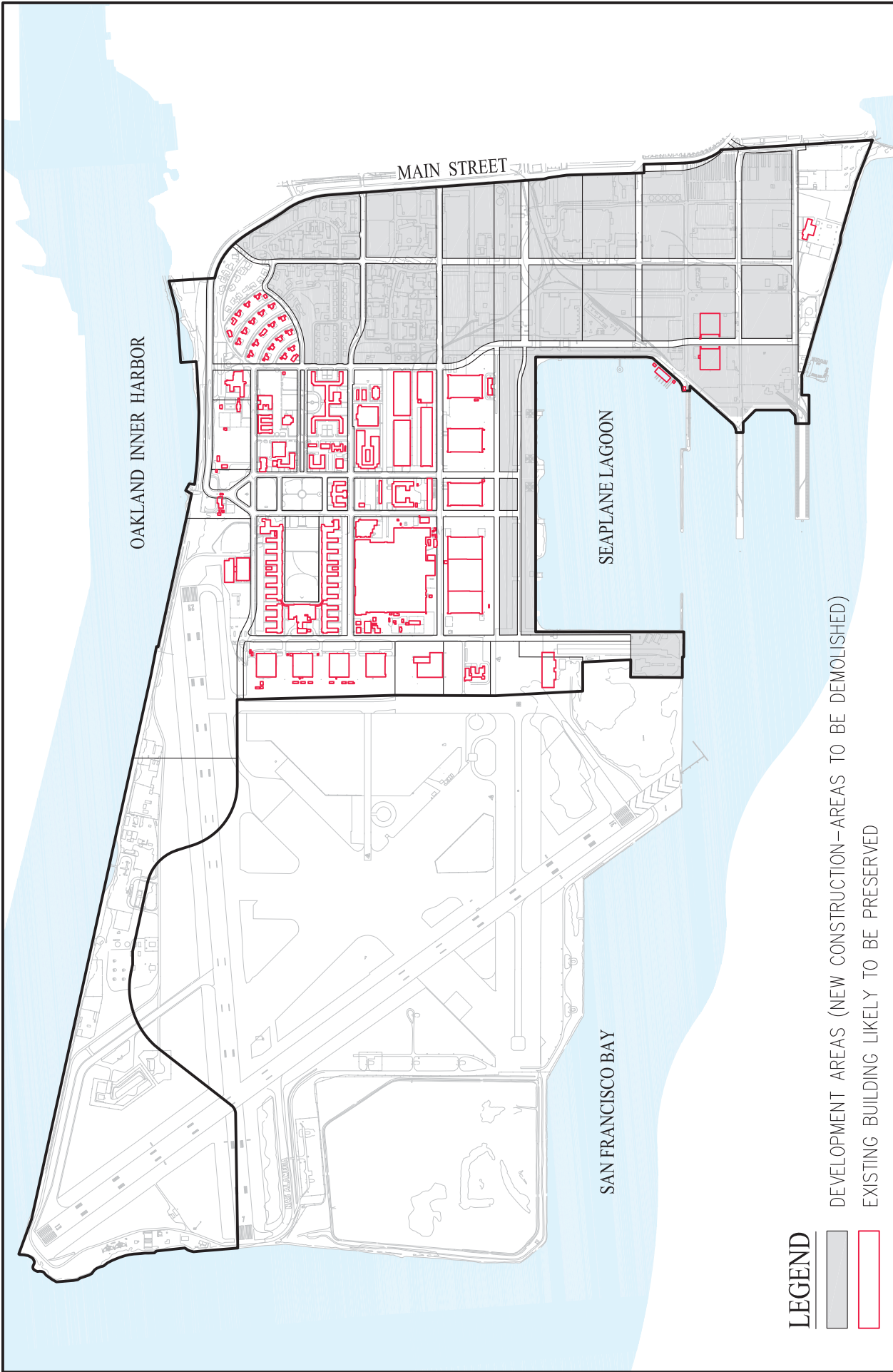

LEGEND

- DEVELOPMENT AREAS (NEW CONSTRUCTION—AREAS TO BE DEMOLISHED)
- EXISTING BUILDING LIKELY TO BE PRESERVED

ALAMEDA POINT
MASTER INFRASTRUCTURE PLAN
 CITY OF ALAMEDA ALAMEDA COUNTY CALIFORNIA
 DATE: JUNE, 2013 SCALE: 1" = 1,500'
Carlson, Barbee, & Gibson, Inc.

FIGURE 5
EXISTING BUILDINGS
LIKELY TO BE PRESERVED

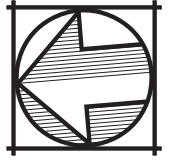

G:\11087-10\ACAD-10\EXHIBITS\BASE CASE ALT - FIGURES\B_5_EX BUILDINGS TO REMAIN.DWG

MAP OF ALL INSTALLATION RESTORATION SITES AT ALAMEDA POINT

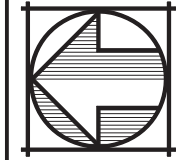
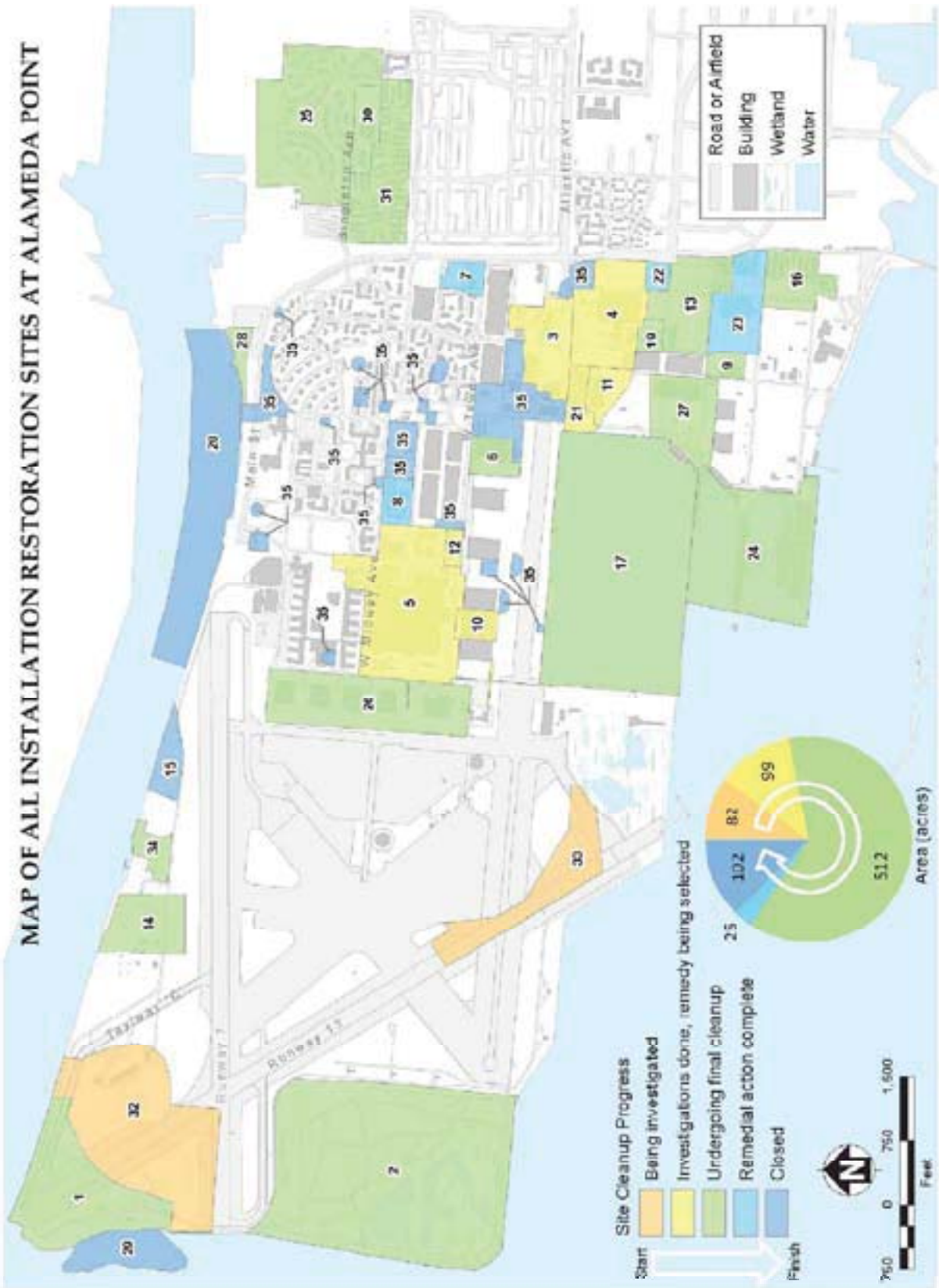
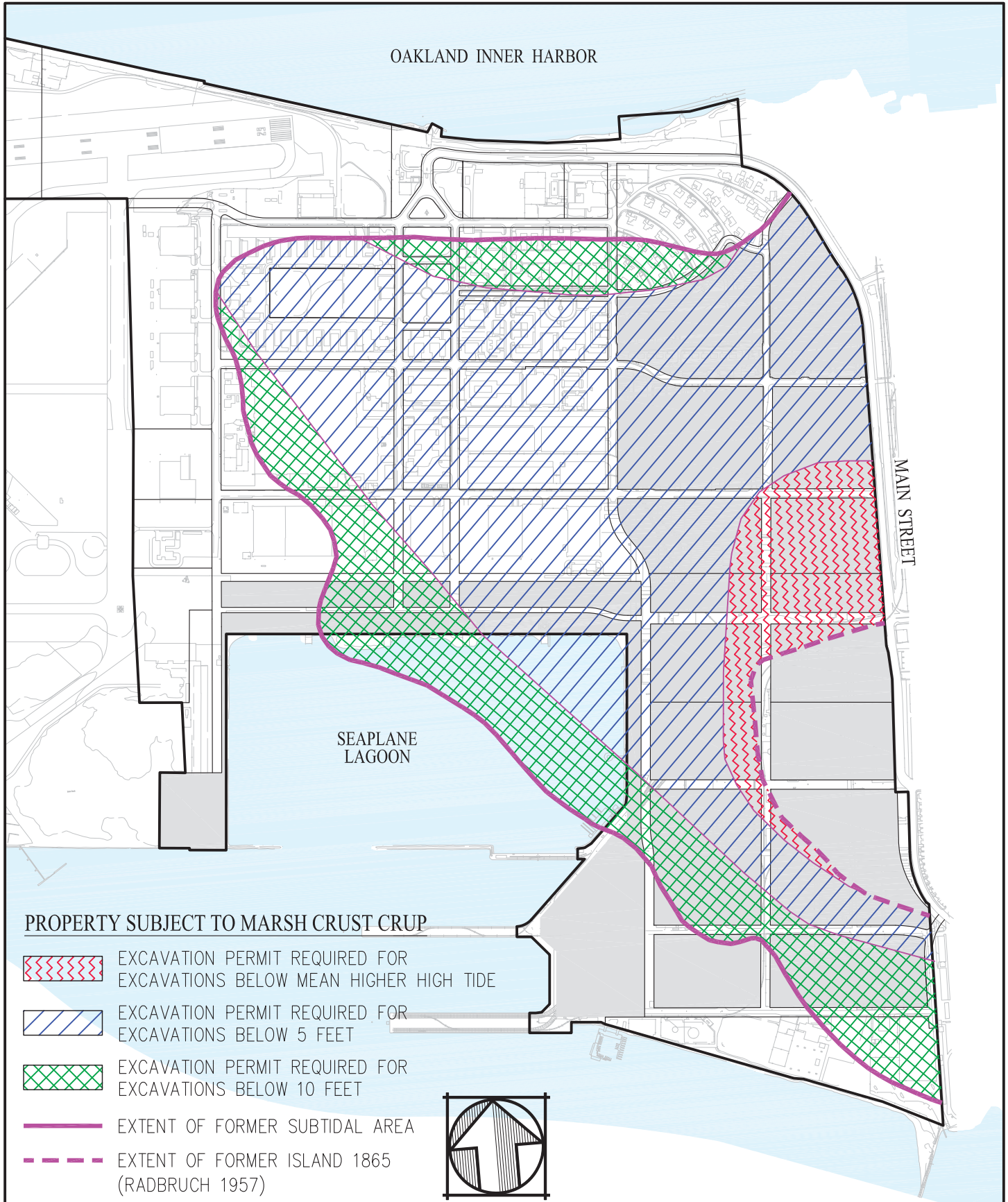

FIGURE 6
IR SITE STATUS
AS OF APRIL, 2013

ALAMEDA POINT
MASTER INFRASTRUCTURE PLAN
CITY OF ALAMEDA ALAMEDA COUNTY CALIFORNIA
DATE: JUNE, 2013 NOT TO SCALE
Carlson, Barbee, & Gibson, Inc.

G:\1087-10\ACAD-10\EXHIBITS\BASE CASE ALT - FIGURES\B_6_IR SITE STATUS.DWG



**ALAMEDA POINT
MASTER INFRASTRUCTURE PLAN**
 CITY OF ALAMEDA ALAMEDA COUNTY CALIFORNIA
 DATE: JUNE, 2013 SCALE: 1" = 1,000'
 Carlson, Barbee, & Gibson, Inc.

**FIGURE 7
MARSH CRUST
ORDINANCE**

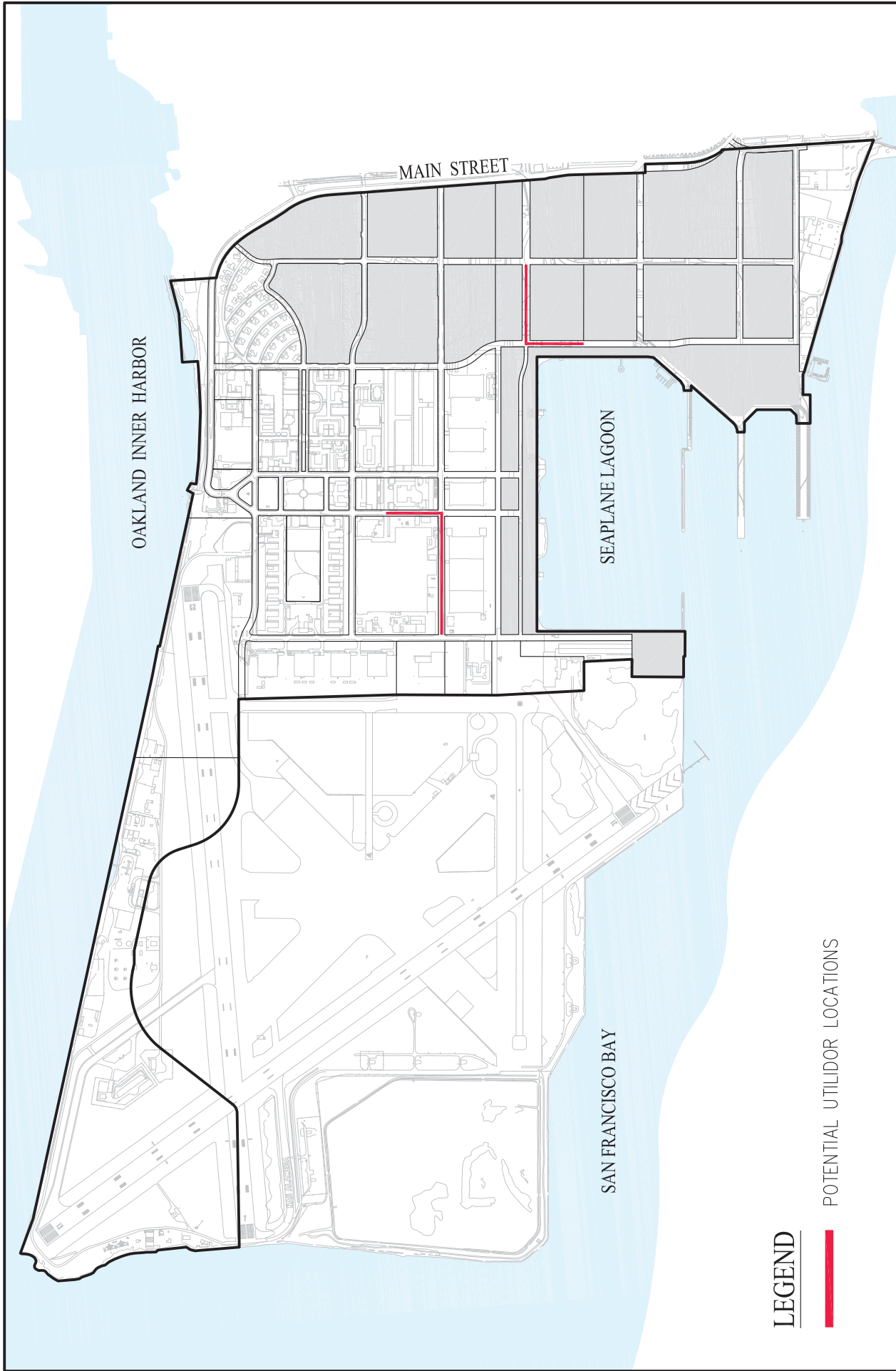

LEGEND

POTENTIAL UTILIDOR LOCATIONS



**ALAMEDA POINT
MASTER INFRASTRUCTURE PLAN**

CITY OF ALAMEDA ALAMEDA COUNTY CALIFORNIA

DATE: JUNE, 2013 SCALE: 1" = 1,500'

Carlson, Barbee, & Gibson, Inc.

**FIGURE 8
UTILIDOR LOCATIONS**

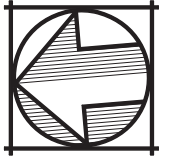

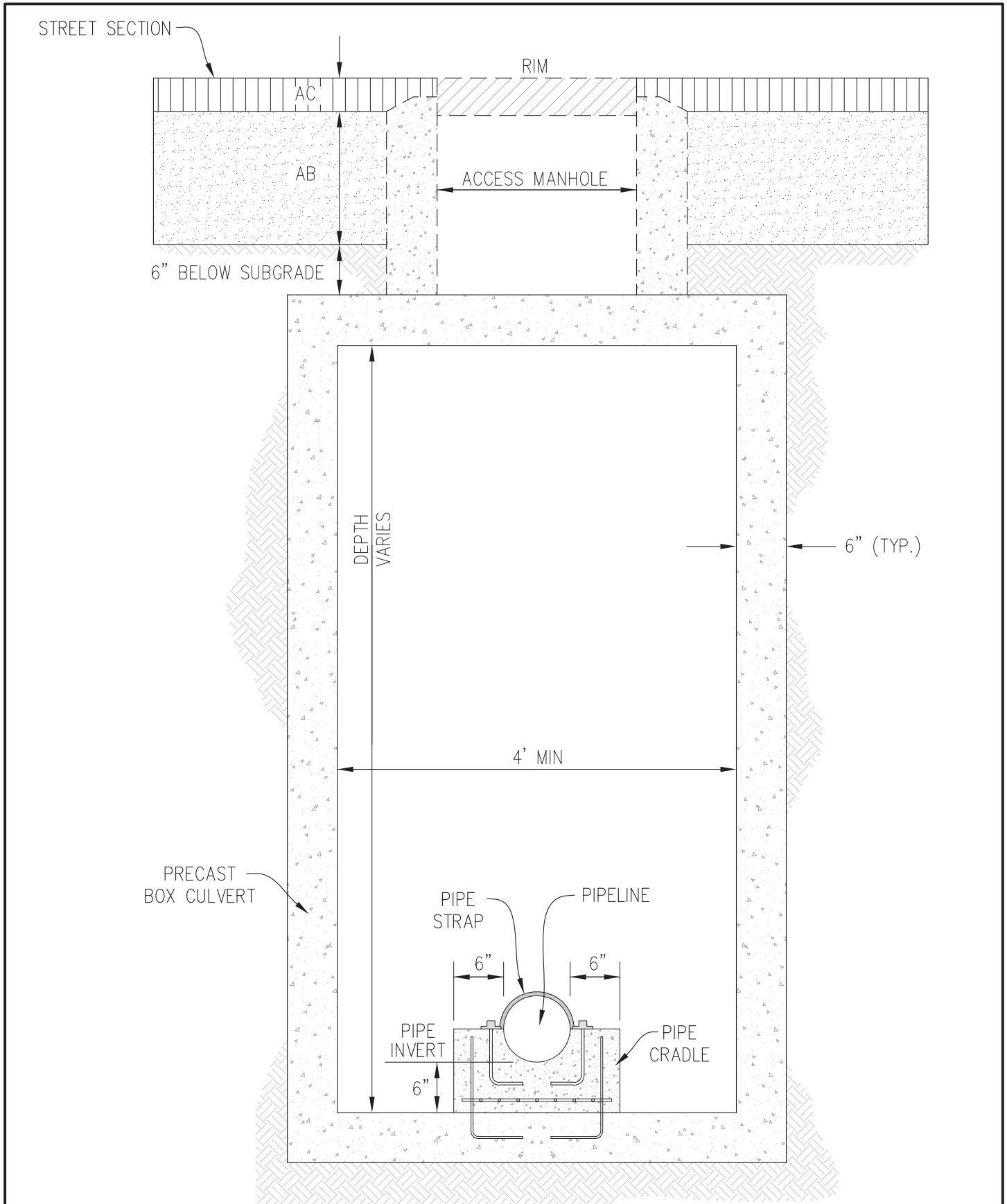

ALAMEDA POINT
 MASTER INFRASTRUCTURE PLAN
 CITY OF ALAMEDA ALAMEDA COUNTY CALIFORNIA
 DATE: JUNE, 2013 NOT TO SCALE
 Carlson, Barbee, & Gibson, Inc.

FIGURE 9
 UTILIDOR CONCEPT

III. FLOOD PROTECTION AND SITE GRADING

A. Sea Level Rise and Adaptive Management

1. Existing Conditions

a. Existing Topography

The existing topography of Alameda Point is generally flat and has gradients ranging between 0.2 and 0.75 percent. The existing elevations throughout the Project Site range between 0.5 and 9.0 (City Datum).

There is an existing slight ridge in the middle of the Project Site, near Midway Avenue. The elevations of this ridge are approximately 7.0. The existing ground slopes away from this ridge either to north or the south. The existing elevations of the southeast quadrant are also elevated, an average elevation of 7.0. This portion of the Project Site includes the existing piers, which are at elevation 9.0.

The low lying areas include the northern entrance to the Project Site at the Main Gate, where the elevation is approximately 1.0. Also, the areas in the northwest corner of the Seaplane Lagoon are at elevations ranging in between 2.0 and 3.4.

The existing elevations of Main Street adjacent to the northeastern portion of the Project Site are also low. The lowest point of Main Street is located at the Main Street / Ferry Terminal Parking Lot intersection, which is at elevation 0.5. This portion of Main Street is drained by an existing storm drain pump station.

The existing topography of the Northwest Territories generally drains northerly to the Oakland-Alameda Estuary. The existing runways are elevated and crowned, approximately at elevation 7.5, and the surrounding areas are depressed, approximately at elevations 1.5 – 5.0.

b. Existing Areas of Potential Flooding

Currently, Federal Emergency Management Agency (FEMA) has not included Alameda Point within a Flood Insurance Study or Flood Insurance Rate Map, since it was a federal facility. The existing areas of potential inundation will need to be mapped and adopted by FEMA. The flood hazards affecting portions of the Project Site include areas subject to flooding in the 100-year tidal event and the perimeter shoreline that is subject to flooding in the 100-year tidal event and wave/wind run up. See Figure 10 depicting the approximate existing areas that are subject to flood hazards within Alameda Point.

The portion of Main Street adjacent to the northeastern portion of the Project Site is identified as within “Zone A”, areas subject to flooding in the 100-year event, on FEMA’s FIRM panel, dated 2009.

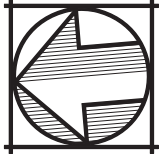
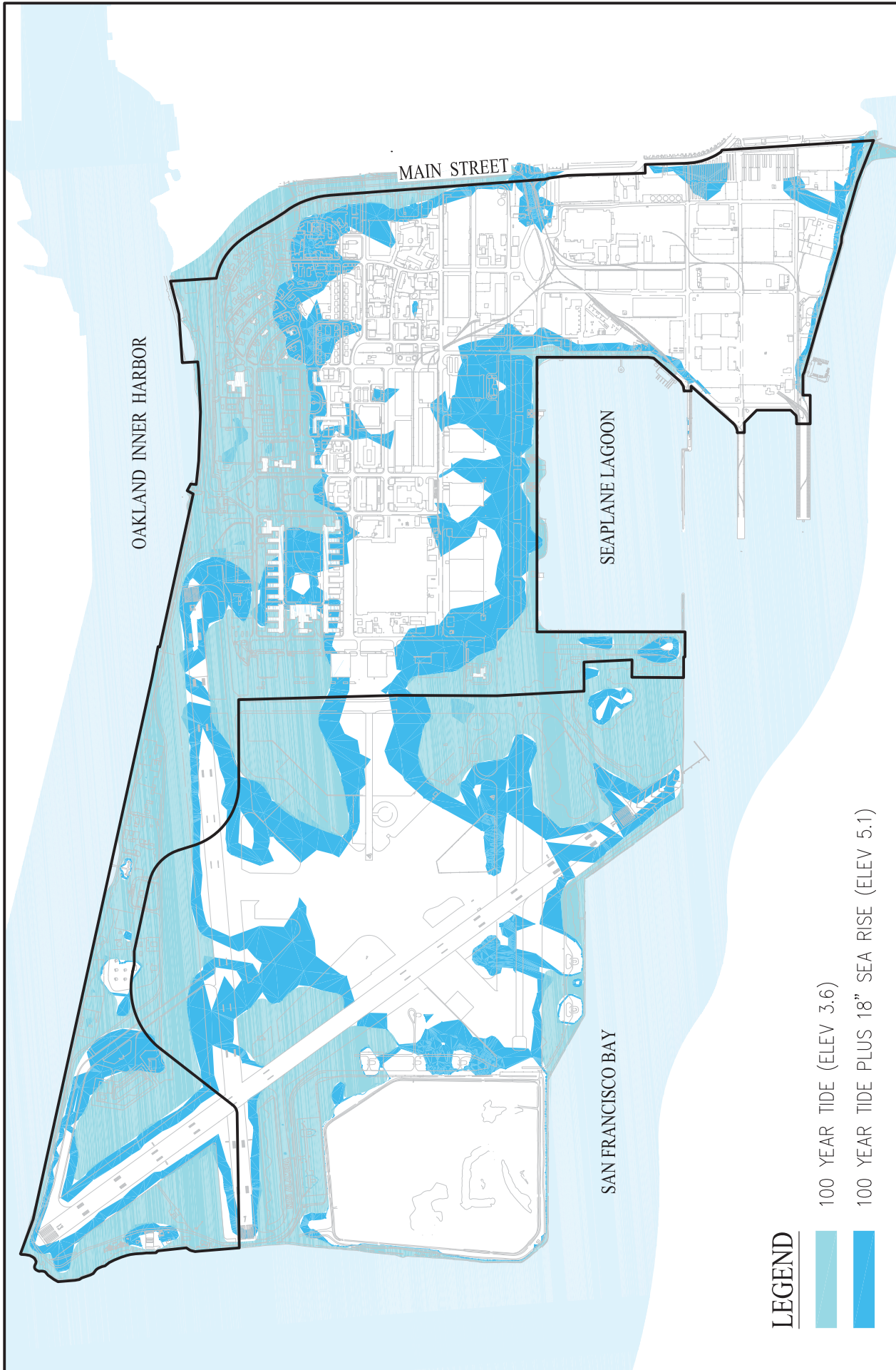

FIGURE 10 EXISTING AREAS OF INUNDATION

**ALAMEDA POINT
MASTER INFRASTRUCTURE PLAN**
 CITY OF ALAMEDA ALAMEDA COUNTY CALIFORNIA
 DATE: JUNE, 2013 SCALE: 1" = 1,500'
Carlson, Barbee, & Gibson, Inc.

G:\1087-10\ACAD-10\EXHIBITS\BASE CASE ALT - FIGURES\B_10_EX AREAS OF INUNDATION.DWG

i. 100-Year Tide

The 100-year tidal elevation is established by the flood frequency analysis prepared by the U.S. Army Corp of Engineers in October 1984. This study, titled “San Francisco Bay – Tidal Stage versus Frequency Study” analyzed the flood frequency based upon tidal data throughout the Bay Area for a 129-year period. One of the tidal gauges utilized in this analysis is located near the piers at the southeastern portion of Alameda Point. The 100-year tidal elevation at the Alameda Point tidal gauge presented in this study is elevation 3.4. In order to account for the increased mean sea level represented between the old and new tidal epochs, the 100-year tidal elevation is increased by 0.2-feet to elevation 3.6 for the MIP.

ii. Wave/Wind Run-Up

The perimeter coastal areas within Alameda Point will be designed to account for wave/wind run up. The prevailing winds at the Project Site are from the west, with typical speeds up to approximately 25 knots. Extreme wind conditions for the Project Site were previously calculated in the Alameda Point Golf Course EIR and are summarized in Table 3.

Table 3 - Wind Conditions

Return Period (Years)	Wind Speed (Knots)
2	29.7
10	36.8
25	40.3
50	43.0
100	45.6

The majority of the shoreline within with Project Site is well protected from wind generated waves and from swell. The northern shoreline along the Oakland-Alameda Estuary and the Seaplane Lagoon shoreline are sheltered from the wind waves. Wave/wind run-up for these shorelines is estimated to be a maximum of 1-foot.

The shorelines along the southern edge of the Project Site, east of the Seaplane Lagoon, are directly exposed to the wind generated waves. The 100-year wind wave heights estimated for these shorelines are approximately 4-feet.

iii. Tsunamis

The Golden Gate limits the propagation of tsunamis through the San Francisco Bay providing sheltering of Alameda Point from the majority of potential tsunami damage. San Francisco Bay has had a tidal gauge, in various locations, recording data since 1854 to present. Over this period of time, there have been approximately 50 creditable tsunamis recorded or observed in the San Francisco Bay region. Of these, only 5 produced run up that exceeded 1.6 ft. (-1.8 City Datum) within the Bay. The best-documented tsunami events are the 1946, 1960 and 1964 tsunamis generated by distant earthquakes in Aleutian Islands, Southern Chile and Prince William Sound, Alaska respectively. The highest recorded wave height associated with a tsunami event at the Alameda tidal gauge was associated with the 1964 Alaskan tsunami event. The tidal gauge recorded a maximum wave height during this

event of approximately 2.3 ft. (-0.8 City Datum). Based on the available records from tidal gauges within the San Francisco Bay Area, this maximum event is representative of a 100-year tsunami event. The approximate maximum wave height associated with this event is less than the 100-year tidal elevation and therefore is below the elevation of the proposed flood protection measures at Alameda Point.

Additionally, the US Geologic Survey (USGS) recently issued a report, “Community Exposure to Tsunami Hazards in California” dated March 2013, which evaluated the potential community exposure to tsunami hazards along the California coastline, including San Francisco Bay. USGS completed simulation modeling of tsunami generation, propagation and run up to determine and investigate the “worst case” type scenario. USGS determined that large ruptures along the Aleutian subduction zone is the most likely to generate the strongest tsunami within the San Francisco Bay and presents the greatest hazard, larger than any other modeled potential source either locally or in the Pacific. Specific to Alameda, this type of modeled tsunami event presented in this USGS report indicates that the maximum onshore run up elevation is 10.6 (City Datum). While this event is an extreme case with a low probability of occurrence, the majority of Alameda Point would be inundated by a tsunami event of this magnitude. This report concludes that because of the City of Alameda’s high percentage of people and businesses within the tsunami prone area, the City has high potential for losses related to this significant tsunami event. Accordingly, proposed developments within the Project Site shall work with the City of Alameda emergency services to establish emergency preparedness plans and evacuation routes for Alameda Point in the case of this extreme event.

iv. Wakes

Large vessels associated with the Port of Oakland’s activities commonly travel along the northern shoreline. Additionally, ferry vessels may enter the Seaplane Lagoon as part of the transit solutions for Alameda Point. This shipping traffic may generate wakes up to approximately 1-foot.

2. Sea Level Rise Criteria

Development sites along the San Francisco Bay shoreline and those that are susceptible to future inundation with sea level rise shall be designed to provide protection or be adaptable to provide future protection to address the expected impacts of climate change. The San Francisco Bay Conservation and Development Commission (BCDC) updated the San Francisco Bay Plan in October 2011 to address the expected impacts of climate change in San Francisco Bay. The updates to the Bay Plan include guidance for addressing future sea level rise when planning projects along the Bay shoreline which are susceptible to future inundation.

The California Climate Action Team’s sea level rise projections, ranging from 10 to 17 inches at mid-century and 31 to 69 inches at the end of the century, currently provide the best available sea level rise projections for the West Coast. The Bay Plan recommends planning for future sea level rise at amounts of 16-inches by 2050 and 55-inches by 2100.

3. Adaptive Management Plan

An Adaptive Management Plan will ensure Alameda Point maintains flood protection and addresses sea level rise over time. Future sea level rise will increase the areas of flooding within the Project Site. The approach of the Adaptive Management Plan commences with constructing an initial flood protection system, as described in Section III.A.4, that is designed to provide protection from the current 100-year tidal event, wave/wind run-up and 18-inches of sea level rise.

Scientific uncertainty remains regarding the pace and amount of future sea level rise, therefore a sea level rise monitoring program will be established to periodically review actual sea level rise amounts, trajectories, and updated projections.

If future sea level rise amounts exceed 18-inches, additional flood protection measures will be implemented. The flood protection system will be adaptively designed to address sea level rise in excess of 18-inches. The adaptive measures will include preserving inland land and right of way along the perimeter of the site such that existing shorelines and floodwalls could be elevated to manage sea level rise. The perimeter improvements shall be designed to allow for the future flood protection measures to be widened and support additional height such that no fill is placed in the Bay. Other adaptive measures that may be implemented include a flexible perimeter protection measure that shifts inland and allows the out board land to be converted to tidal wetlands. This type of solution is only anticipated as an option for the western shoreline of the Seaplane Lagoon and Northwest Territories. A funding mechanism to implement these future adaptive measures will be established for the Alameda Point area. A Geologic Hazard Abatement District (GHAD) may be established at Alameda Point to serve as the mechanism to monitor, maintain and implement the adaptive flood protection measures.

The initial and future perimeter flood protection measures are to be designed in accordance with the National Flood Protection Insurance Program (NFIP), as described in Title 4, Chapter 1, Section 65.10 of the Code of Federal Regulations.

4. Initial Flood Protection System

a. Flood Protection Criteria

The flood protection criteria for Alameda Point combine those outlined by the FEMA with additional consideration for sea level rise. The FEMA guidelines for establishing the flood elevations vary for shoreline areas and for inland areas. FEMA's design criteria for shoreline areas require that the flood protection measures be established above the 100-year tidal elevation plus consideration for wave / wind run-up. If the flood protection measure is a perimeter levee, the crest elevation must include the greater of either 2-feet above the 100-year tidal elevation or 1-foot above the 100-year tidal elevation plus wave / wind run up. The FEMA design criteria for the inland areas consider only the 100-year tidal elevation. The minimum elevations of the initial flood protection system for Alameda Point will adhere to FEMA's guidelines plus an additional 18-inches of sea level rise.

b. Development Areas

The Development Areas will be elevated to achieve the initial flood protection criteria. The minimum elevations of the inland Development Areas will be designed to be at or above the 100-year tidal elevation plus 18-inches of sea level rise. The finish floors of all new structures will be constructed 24-inches above the 100-year tidal elevation, providing an additional 6-inches above the initial 18-inches amount of sea level rise. The minimum elevations of the perimeter

of the Development Areas will be designed to be at or above the 100-year tidal elevation, plus consideration for wave/wind run up and 18-inches of sea level rise. The flood protection measures within the Development Areas will be phased consistent with the development phasing.

The shorelines will be designed to dedicate the necessary right-of-way and land for the future adaptive measures that will be employed as part of Alameda Point's Adaptive Management Plan for future sea level rise in excess of 18-inches. Typically, a 50 to 90-foot wide corridor shall be reserved along the Development Area shorelines. This future adaptive measures corridor is anticipated to encompass the Bay Trail alignment. This corridor will accommodate a future levee or floodwall elevated to provide protection from future sea level rise.

c. Reuse Areas

The Reuse Areas include historic structures and landscapes that will be preserved. Generally, many of the existing structures are elevated relative to the street elevations. A sample of the existing structures was field surveyed. The majority of these structures had an existing finish floor elevation above the 100-year tidal elevation plus sea level rise. However, there were some existing structures in the northwest and southwest portions of the Project Site that have existing finish floor elevations below the 100-year tidal elevation plus 18-inches of sea level rise. Additionally, the majority of the existing streets within the Reuse Areas are at an elevation below the 100-year tide. Therefore, the initial flood protection system for the Reuse Areas will be comprised of a perimeter system of levees and floodwalls. These perimeter measures will be designed to have a crest elevation that meets FEMA's guidelines, which include 100-year tidal elevation, plus wave / wind run up, 18-inches of sea level rise plus 2-feet of additional protection (freeboard). The construction of the initial flood protection system for the Reuse Areas will be completed over time as described in the Phasing and Implementation Section XII.

The levees and floodwalls will be designed to be adapted if the amount of future sea level rise exceeds 18-inches. Typically, a 50-foot wide corridor shall be reserved along the Reuse Area shorelines. This future adaptive measures corridor is anticipated to encompass the Bay Trail alignment. This corridor will accommodate further elevating the initial construction levee or floodwall to provide increased protection from future sea level rise.

See Figure 11 depicting the initial flood protection system and minimum elevations throughout Alameda Point.

d. Bay Trail - NW Territories and VA Property

In general, the Bay Trail outside of the Development and Reuse Areas within the NW Territories and VA Property will be constructed along the shoreline. The minimum elevation of the Bay Trail shall be in accordance with BCDC's design guidelines for public use areas along the Bay shoreline. Generally, the Bay Trail will be constructed at an elevation above the anticipated amount of sea level rise within the design life of this facility. However, the Bay Trail within the NW Territories and VA Property are not expected to be constructed to the FEMA standards of a flood protection berm / levee and therefore not providing flood protection for the VA Property.

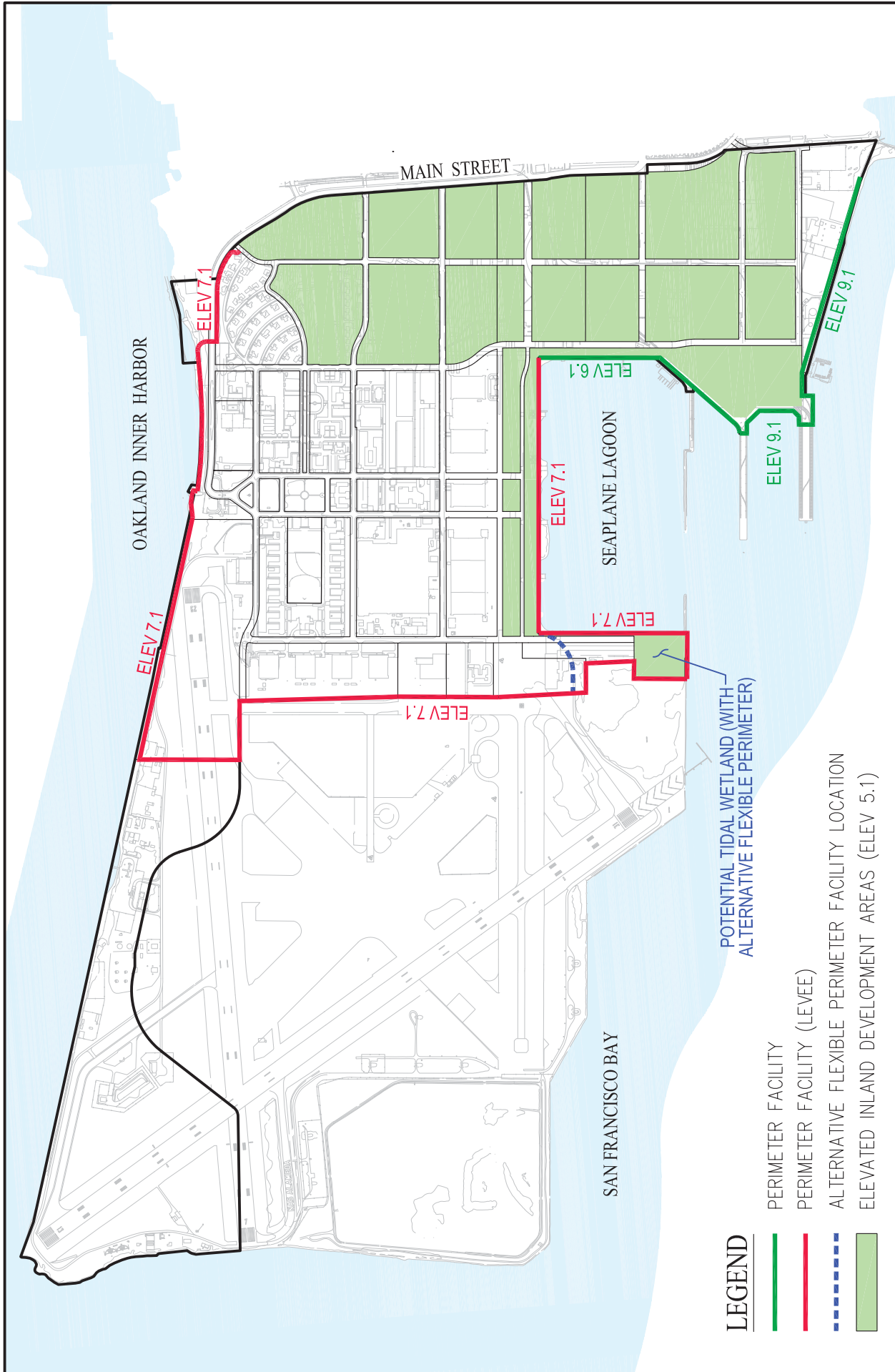

LEGEND

- PERIMETER FACILITY
- PERIMETER FACILITY (LEVEE)
- - - ALTERNATIVE FLEXIBLE PERIMETER FACILITY LOCATION
- ELEVATED INLAND DEVELOPMENT AREAS (ELEV 5.1)

POTENTIAL TIDAL WETLAND (WITH ALTERNATIVE FLEXIBLE PERIMETER)

ALAMEDA POINT
MASTER INFRASTRUCTURE PLAN
 CITY OF ALAMEDA ALAMEDA COUNTY CALIFORNIA
 DATE: JUNE, 2013 SCALE: 1" = 1,500'
Carlson, Barbee, & Gibson, Inc.

FIGURE 11
INITIAL FLOOD PROTECTION



e. Stormwater System

A new stormwater collection system will be constructed in phases within the Project Site. The stormwater system will include the construction of new outfall structures that include tide valves to prevent tidal influences in the system. For the low lying watersheds, pump stations will be constructed to minimize the depth of the stormwater pipelines and ensure stormwater discharge during extreme tides and 18-inches of sea level rise. The new stormwater system will be designed to convey the 25-year design storm with 6-inches of minimum freeboard. Additionally, the system will accommodate the 100-year storm with a maximum ponding in the streets of up to the top of curb at low points in the street profiles.

5. Site Grading Design Criteria

The site grading design criteria for the various flood protection measures presented above are summarized in Table 4.

Table 4 - Site Grading Design Criteria

	Location	Improvements	Min. Elev. (City Datum)	Design Criteria
Development Areas (New Construction)				
Perimeter	Eastern Seaplane Lagoon	Raise Ex Revetment	6.1	100-Year Tide +18" Sea Level Rise +1' Wind/Wave
	West & North Project Boundary	Raise Ex Headwall or Revetment	7.1	100-Year Tide +18" Sea Level Rise +2' Wind/Wave
	Existing Piers	Raise Ex Floodwall	9.1	100-Year Tide +18" Sea Level Rise +4' Wind/Wave
	Southeast Project Boundary	Raise Ex Revetment	9.1	100-Year Tide +18" Sea Level Rise +4' Wind/Wave
Inland	Areas Adjacent to Main Street	Raise Finish Grade	5.1	100-Year Tide +18" Sea Level Rise
	Areas Adjacent to Seaplane Lagoon	Raise Finish Grade	6.1	100-Year Tide +18" Sea Level Rise +1' Wind/Wave
Reuse Areas				
Perimeter	West & North Project Boundary	Construct Berm or Raise Ex Revetment	7.1	100-Year Tide +18" Sea Level Rise +1' Wind/Wave
Inland	Existing Areas to Remain	Existing Elevations to Remain	-	Existing Elevations to Remain As Is

	Location	Improvements	Min. Elev. (City Datum)	Design Criteria
Main Street				
Reconstruction	NW Alameda Ferry Terminal Parking Lot Entrance to Atlantic Ave.	Raise Main Street	3.6	

6. Flood Protection System Adaptations for Future Sea Level Rise

a. Adaptive Measure Criteria

As previously described, the initial flood protection system will provide flood protection for up to 18-inches of sea level rise. These initial flood protection measures will be designed to be adapted if the amount of future sea level rise exceeds 18-inches. The adaptive measures for the Development Areas will include constructing a perimeter system of levees and floodwalls. The adaptive measures for the Reuse Areas will include elevating the initially constructed perimeter levees and floodwalls. The adapted perimeter measures will be elevated to meet FEMA's guidelines with the necessary amount of sea level rise. The inland edge along the eastern boundary of Alameda Point will rely on protection from sea level rise in excess of 18-inches by regional flood protection measures along the perimeter of the remainder of Alameda.

In some locations, the location of the perimeter system may be shifted inland as part of the implementation of adaptive measures. This would allow for the creation of tidal wetlands as part of the Project's response to climate change.

A funding mechanism will need to be established to generate long term funding from the Alameda Point residents and businesses to monitor sea level rise and implement the phased construction of the adaptive flood protection measures to meet future projections. This mechanism may be GHAD. The funding and financing mechanisms will be evaluated as part of future development and financing discussions for Alameda Point.

See Figure 12 through Figure 14 depicting the future flood protection system and how the adaptive measures will be implemented for future sea level rise in excess of 18-inches.

b. Stormwater System

The proposed stormwater system at Alameda Point can continue to collect and convey the required design storms regardless of the amount of future sea level rise. For those watersheds that do not include pump stations with the initial flood protection system, the adaptive measures will include the construction of a pump station, such that all watersheds within Alameda Point have pump stations as part of the stormwater collection systems. The pump stations will ensure stormwater discharge to the surrounding waters in extreme tides and with any amount of sea level rise.

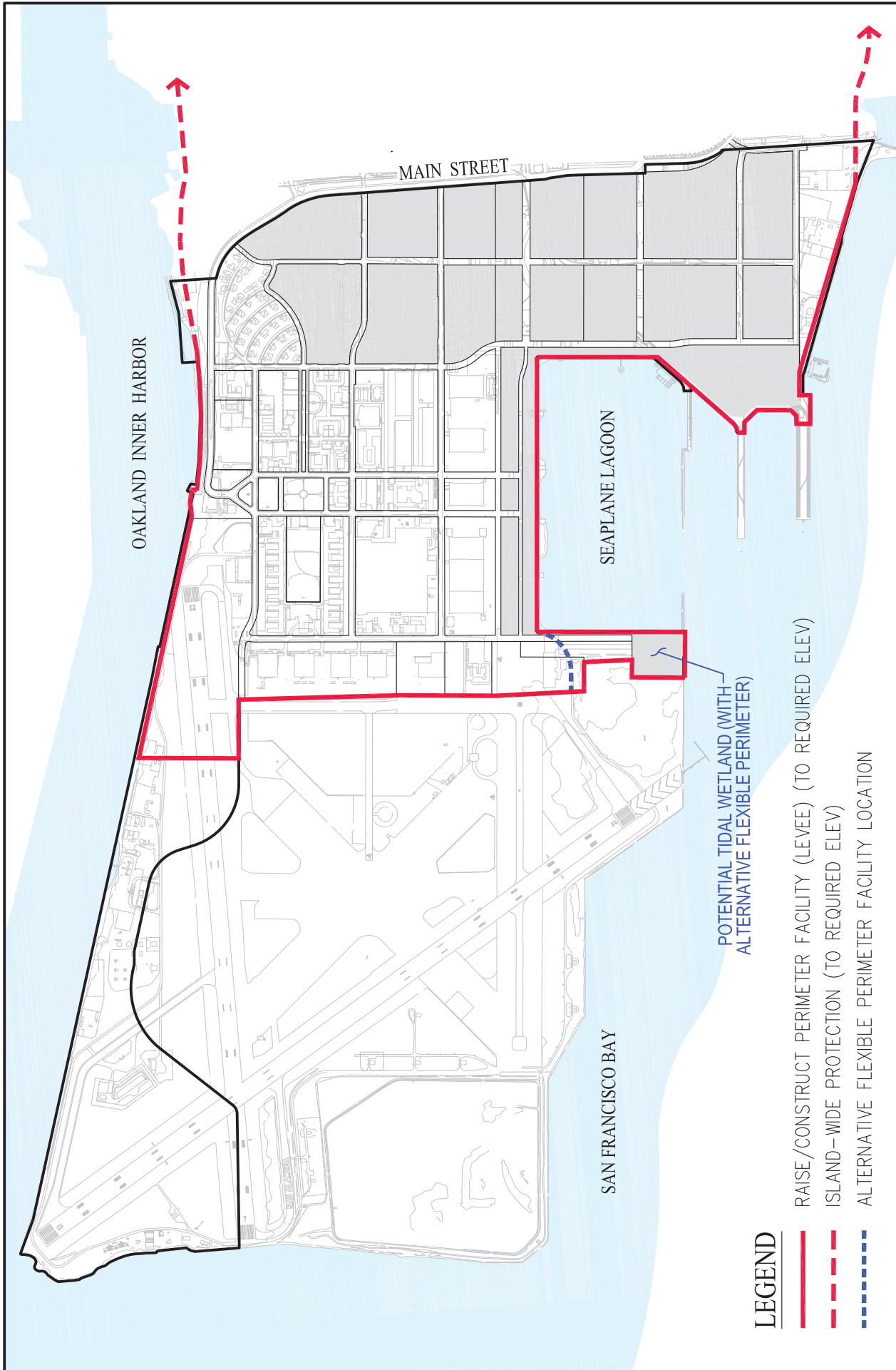

LEGEND

- RAISE/CONSTRUCT PERIMETER FACILITY (LEVEE) (TO REQUIRED ELEV.)
- - - ISLAND-WIDE PROTECTION (TO REQUIRED ELEV.)
- - - ALTERNATIVE FLEXIBLE PERIMETER FACILITY LOCATION
- ~ ~ ~ POTENTIAL TIDAL WETLAND (WITH ALTERNATIVE FLEXIBLE PERIMETER)

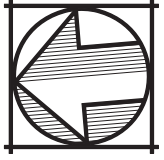
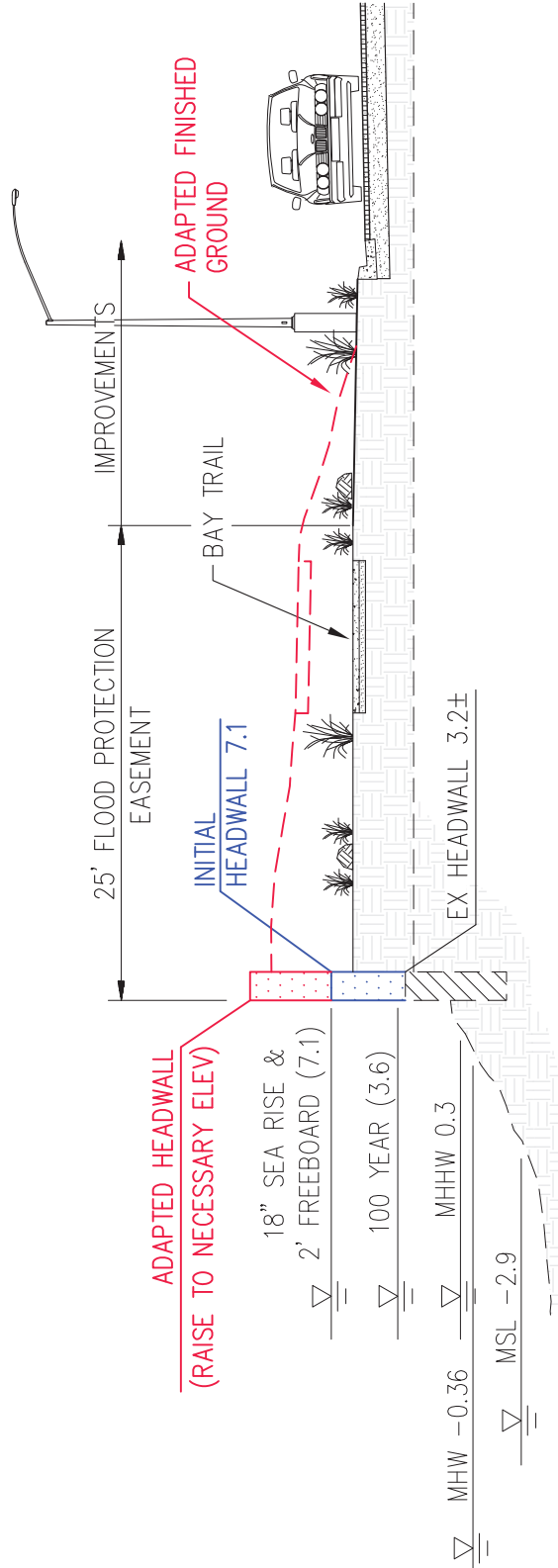

FIGURE 12
ADAPTED FLOOD PROTECTION

ALAMEDA POINT
MASTER INFRASTRUCTURE PLAN
 CITY OF ALAMEDA ALAMEDA COUNTY CALIFORNIA
 DATE: JUNE, 2013 SCALE: 1" = 1,500'
Carlson, Barbee, & Gibson, Inc.

G:\1087-10\ACAD-10\EXHIBITS\BASE CASE ALT - FIGURES\XB_12_ADAPTED FLOOD PROTECTION.DWG



RAISE HEADWALL

NOT TO SCALE

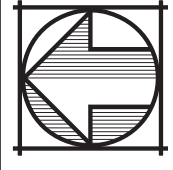

**FIGURE 13
FLOOD PROTECTION
ADAPTIVE MEASURES**

**ALAMEDA POINT
MASTER INFRASTRUCTURE PLAN**
CITY OF ALAMEDA ALAMEDA COUNTY CALIFORNIA
DATE: JUNE, 2013 NOT TO SCALE
Carlson, Barbee, & Gibson, Inc.

G:\1087-10ACAD-10\EXHIBITS\BASE CASE ALT - FIGURES\B_13_ADAPTIVE MEASURES (HEADWALL - BCDC).DWG

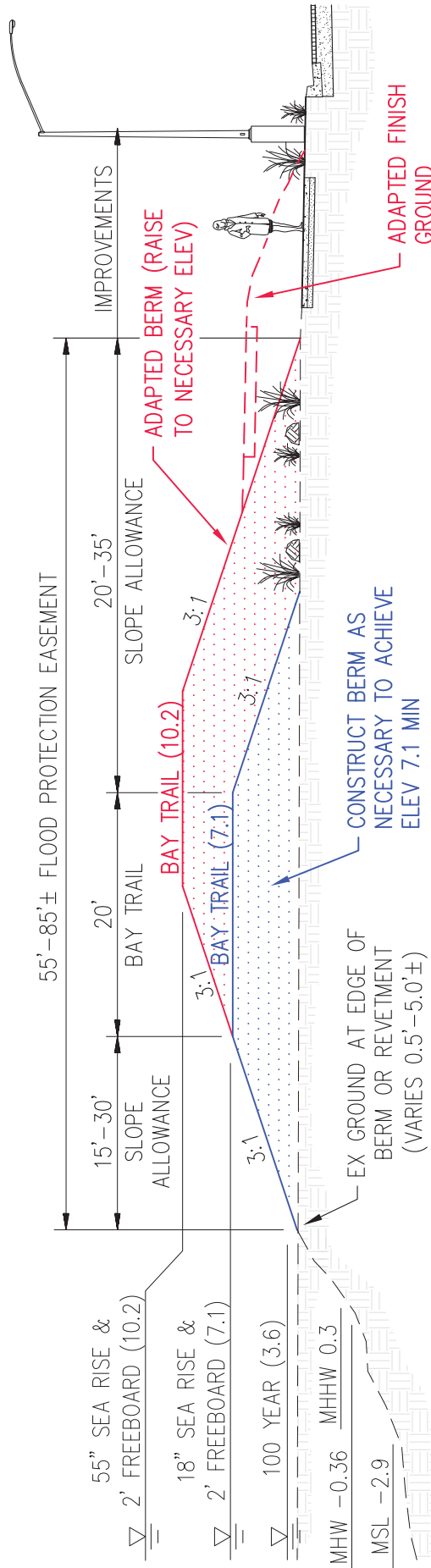

RAISE BERM OR RETEMENT

NOT TO SCALE



**FIGURE 14
FLOOD PROTECTION
ADAPTIVE MEASURES**

**ALAMEDA POINT
MASTER INFRASTRUCTURE PLAN**
CITY OF ALAMEDA ALAMEDA COUNTY CALIFORNIA

DATE: JUNE, 2013 NOT TO SCALE

Carlson, Barbee, & Gibson, Inc.

G:\1087-10\ACAD-10\EXHIBITS\BASE CASE ALT - FIGURES\B_14_ADAPTIVE MEASURES (BERM - BCDC).DWG

7. Sea Level Rise Monitoring Program

An on-going sea level rise monitoring and financing program will be established for Alameda Point. This program may be managed through a GHAD. It will be administered through the City of Alameda and funded through the residents and businesses at Alameda Point. The program will review the sea level rise estimates prepared for the San Francisco Bay by the National Oceanic Atmospheric Administration, as well as other relevant publications regarding updated sea level rise estimates that are available at that time. The review will estimate when improvements to the initial flood protection system will need to be implemented, confirm that sufficient funds will be available to construct the improvements when needed, and, if necessary, accelerate the construction schedule and/or funding of improvements. Initially, it is anticipated that these reviews will be conducted every 5 years, however, more frequent reviews will occur over time, especially if new regulatory requirements are created to address sea level rise or the rate of sea level rise projections increases.

8. FEMA Floodplain

Initially, the existing areas of potential inundation within Alameda Point will need to be mapped and adopted by FEMA. Then at the time that design of flood protection measures is being completed, a Conditional Letter of Map Revision (CLOMR) shall be processed and approved by FEMA. The CLOMR will demonstrate FEMA's concurrence that design of the flood protection measures will remove the proposed development areas from the flood zones. Once the flood protection measures have been constructed, a field survey can be completed to document the as-built elevations of these facilities. This information will be used to process a final Letter of Map Revisions (LOMR). Once the LOMR is approved by FEMA, the FIRM panel will be revised to depict the constructed flood protection measures and remove the protected areas from the floodplain. The CLOMR and LOMR can be prepared and processed in phases with the development phasing.

9. Earthwork Quantities

The site grading activities will include the geotechnical corrective measures to stabilize the site and site grading to achieve minimum elevations described above. The estimated earthwork quantities of these activities is approximately 25,000 cubic yards of cut and 1,800,000 cubic yards of fill. Therefore, it is estimated that approximately 1,775,000 cubic yards of import material will be required in order to complete the necessary site grading including a surcharge operation discussed in Section III.B.2.c. The import materials may be either trucked or barged to the Project Site, depending on available sources. See Figure 15 depicting the areas where fill material is required in order to achieve the minimum elevations specified in the site grading design criteria. This does not include the fill material that may be required for the Bay Trail outside of the Development and Reuse Areas.

The geotechnical corrective measures and site grading will be phased with the development phasing. The surcharge operation will likely include additional sub-phases in order to optimize and minimize the amount of import and export of materials for this operation.

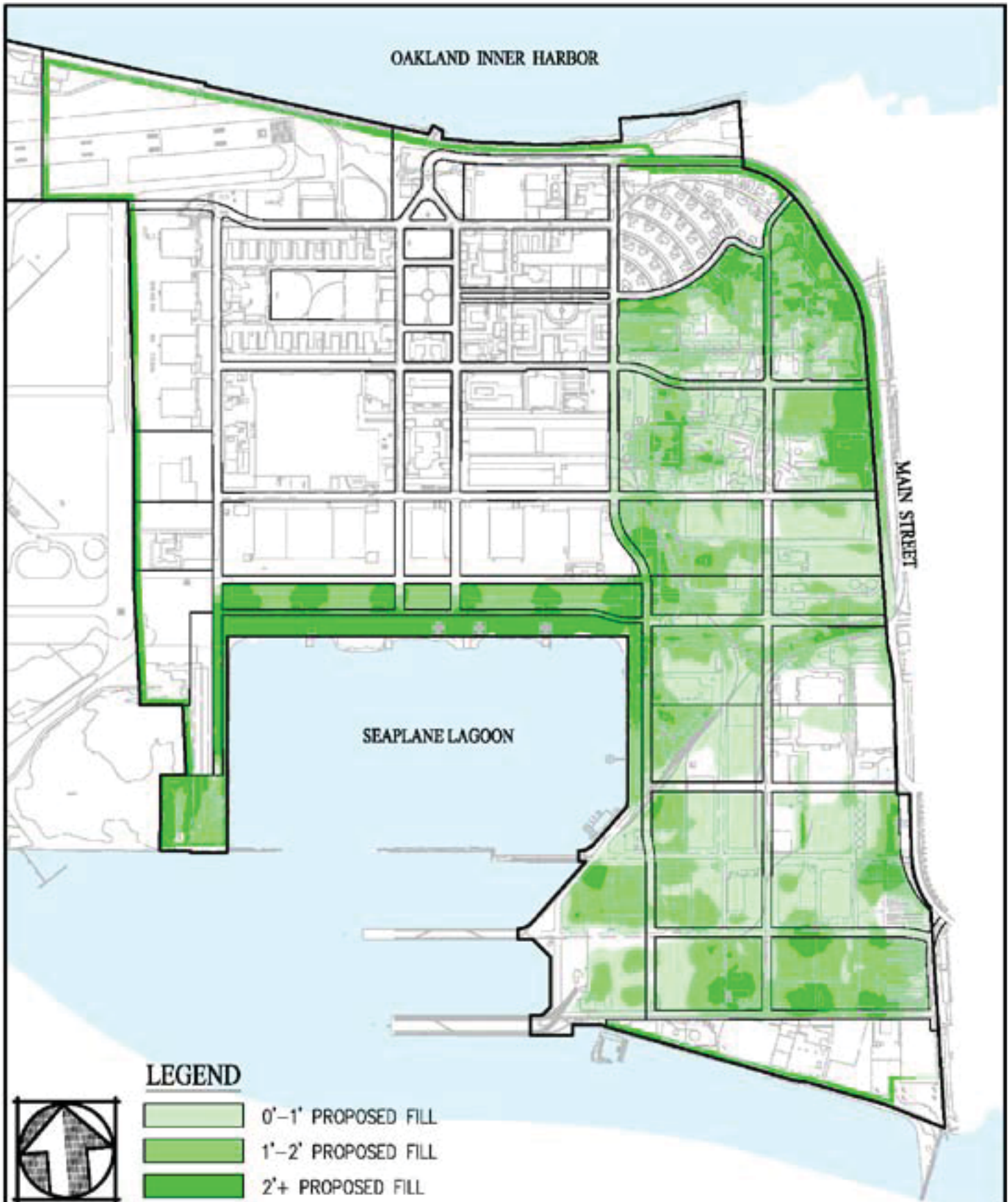

ALAMEDA POINT
MASTER INFRASTRUCTURE PLAN
 CITY OF ALAMEDA ALAMEDA COUNTY CALIFORNIA
 DATE: JUNE, 2013 SCALE: 1" = 1,000'
Carlson, Barbee, & Gibson, Inc.

FIGURE 15
FILL AREAS MAP

B. Geotechnical Conditions

1. Subsurface Conditions

The subsurface conditions at Alameda Point generally consist of artificial fill of varying thickness. Young Bay Mud exists beneath the fill in the portions of the site to the north of the Seaplane Lagoon with the greatest thickness of approximately 130 feet. Merritt Sand and the San Antonio formation sand exist directly beneath the fill in the southeastern portion of the site, approximately 60 to 70 feet in thickness, and dipping beneath the Young Bay Mud to the north and the west. Yerba Buena Mud, also commonly called Old Bay Mud, lies beneath the San Antonio formation.

Due to site elevations and proximity to the San Francisco Bay, the site has relatively shallow groundwater. Based on historic groundwater measurements, the groundwater is approximately 4 to 6 feet below existing grade of the site.

Much of the existing fill and some of the Merritt Sand deposits are potentially liquefiable. The Young Bay Mud deposits are highly compressible under loads associated with fill and buildings. The Young Bay Mud is also soft, typically leading to relatively low stability of cuts and slopes as well as low bearing capacity.

2. Geotechnical Considerations

The main geotechnical considerations for Alameda Point are commonly encountered at waterfront development sites throughout the Bay Area. The considerations include:

- Shoreline Slope Stability
- Liquefaction
- Compressible Soils
- Underground Utility Construction

These considerations and proposed corrective measures are discussed below. A design-level geotechnical analysis to confirm the necessary corrective measures shall be prepared as part of the design process of proposed improvements.

a. North Shoreline

i. Slope Stability

The northern shoreline of Alameda Point is adjacent to a portion of the Port of Oakland's shipping channel. The historical dredging of the shipping channel has resulted in the northern shoreline having a steep slope below the water surface, down to the bottom of the channel. In 2009, the Port of Oakland completed a project deepening and widening the Inner and Outer Harbor shipping channels. This project included deepening of the shipping channel along the northern shoreline of Alameda Point. The static slope stability and seismic performance of the northern shoreline was evaluated through the permitting process of the Port's recent project.

The Port analyzed the slope stability of various locations along the northern shoreline of Alameda Point. The locations of the cross sections the Port analyzed are shown on Figure 16. The Port's analysis concluded that the static stability of cross section I-I' was marginal and the seismic performance was poor with potential deformations at all seismic levels.

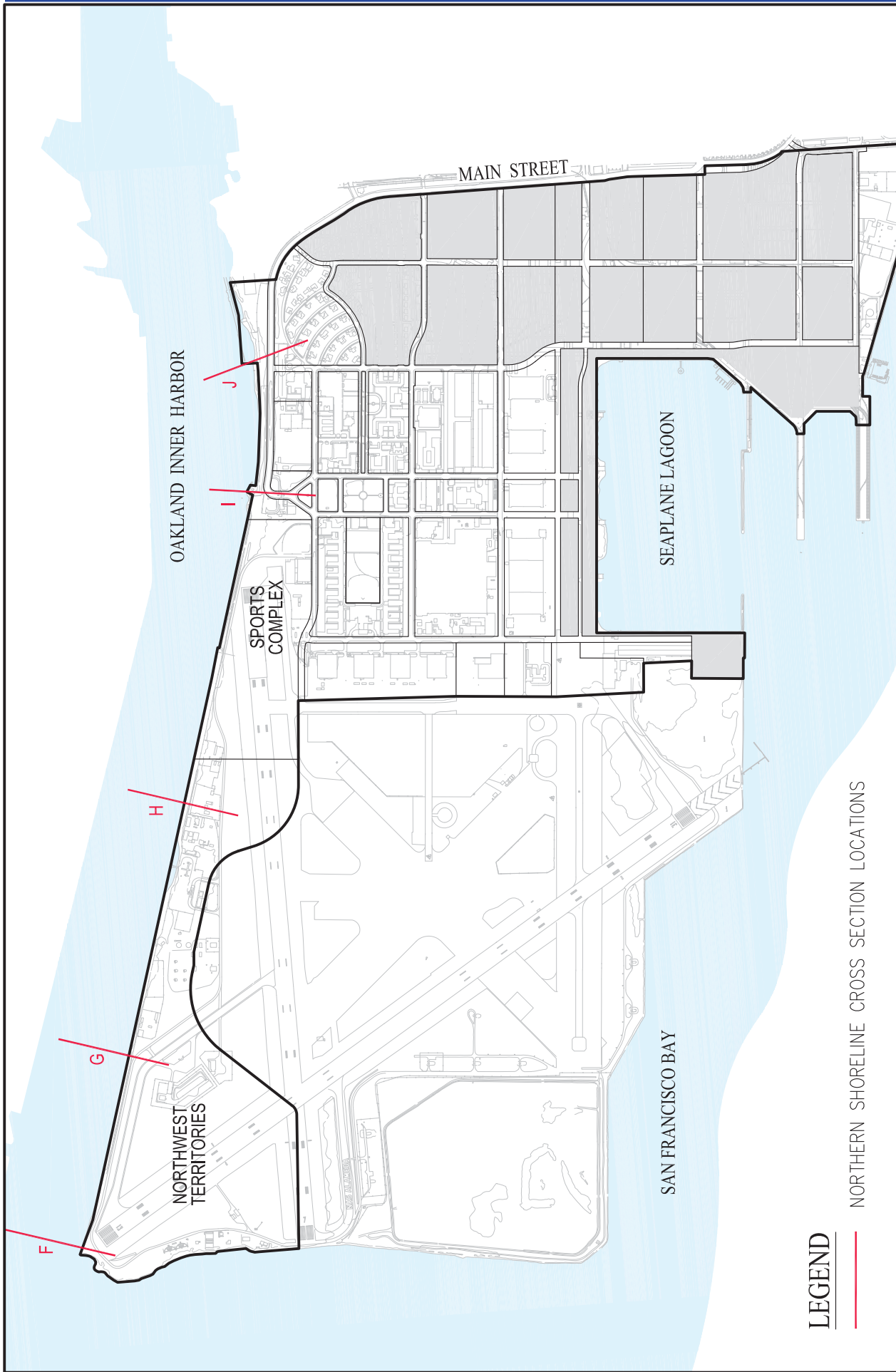

FIGURE 16
NORTHERN SHORELINE
CROSS-SECTION LOCATIONS

ALAMEDA POINT
MASTER INFRASTRUCTURE PLAN
 CITY OF ALAMEDA ALAMEDA COUNTY CALIFORNIA
 DATE: JUNE, 2013 SCALE: 1" = 1,500'
Carlson, Barbee, & Gibson, Inc.

G:\1087-10\ACAD-10\EXHIBITS\BASE CASE ALT - FIGURES\XB_16_N SHORELINE (CROSS-SECTIONS).DWG

The seismic performance of cross section J-J' was concluded to be good at the channel limit but poor at the shoreline. The additional cross sections adjacent to the Northwest Territories, F-F', G-G', and H-H', were found to be stable under static conditions. But, the seismic conditions were also predicted to experience deformations at these cross sections. In summary, the Port's analysis indicated that the northern shoreline was marginally stable in static conditions, but had predicted deformations to occur in seismic conditions.

As part of the MIP, additional analyses of the slope stability of cross sections I-I' and J-J' have been conducted to verify the Port's conclusions. The MIP slope stability calculations confirm that the northern shoreline slopes adjacent to the Development and Reuse Areas are marginally stable under current conditions. Any new loads from fill placement or buildings within 50 feet of the northern shoreline would likely have an impact on static slope stability. Additionally, the MIP calculations also predict deformations under seismic conditions, ranging from 6-inches to over 3-feet, which are considered seismically "unstable" under the California Geological Survey presented in Special Publication 117A (SP117A). According to these guidelines, such deformation "may be sufficient to cause serious ground cracking or enough strength loss to result in continuing (post seismic) failure."

Deformations could extend more than 1,000-feet from the shore at cross section I-I' and approximately 200-feet at cross section J-J'. The distance of potential deformation for the portion of the northern shoreline adjacent to the Northwest Territories is approximately 200-feet.

Lateral stability issues at the shoreline are not unique to this site and are found in other sites with similar subsurface conditions along the border of the San Francisco Bay. The amount of potential displacement and potential distance from the shoreline are exacerbated by the adjacent dredge cut in the channel. The amount of displacement and distance from the shoreline can be refined as part of the project design by performing additional field exploration and soil testing along with using more advanced analytical methods, such as numerical modeling.

See Figure 17 depicting the approximate zones of deformation along the northern shoreline in seismic activities.

ii. Corrective Measures

For the portion of the northern shoreline adjacent to the Reuse and Development Areas and the Sports Complex a significant setback from the shoreline is not feasible. There are existing key components of infrastructure, such as Main Street, Pump Station 1 and the 20-inch force main, within the zone of potential deformation. Therefore, strengthening of the shoreline will be necessary in these areas to reduce the loss or damage of these facilities in a seismic event. The most cost effective shoreline stabilization measure is anticipated to be performing ground improvement such as soil/cement mixing. Because both the liquefiable fill and Young Bay Mud impact the seismic slope stability, the soil/cement mixing will need to extend about 40 feet below the ground surface to the bottom of the Young Bay Mud layer. To appropriately improve shoreline stability it is estimated that the soil treatment may need to be performed on 15 to 30 percent of the soil volume over an area between 20 to 30 feet wide. Other shoreline improvement measures, such as a levee and flood protection

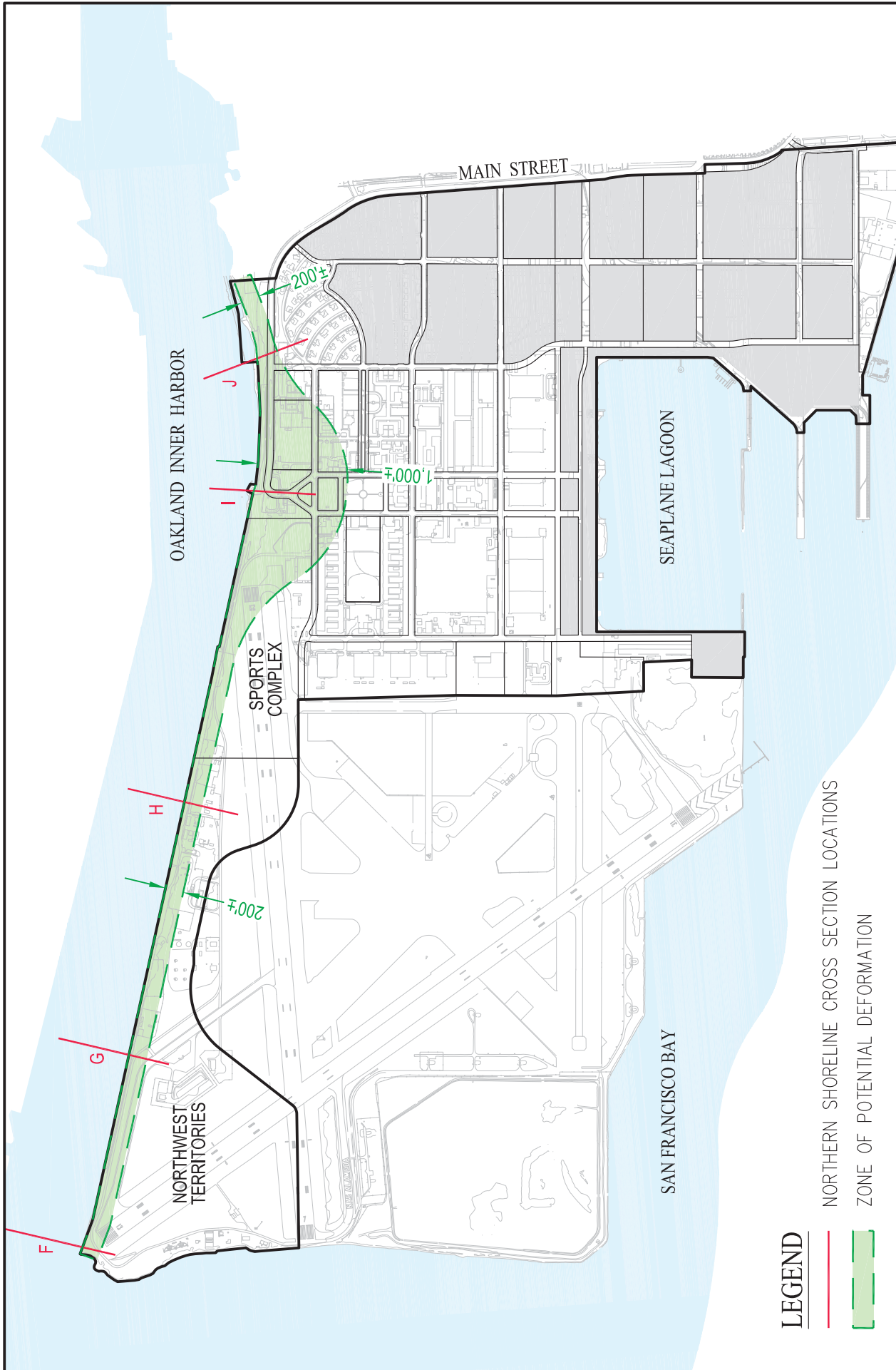

LEGEND

— NORTHERN SHORELINE CROSS SECTION LOCATIONS

— ZONE OF POTENTIAL DEFORMATION

**ALAMEDA POINT
 MASTER INFRASTRUCTURE PLAN**
 CITY OF ALAMEDA ALAMEDA COUNTY CALIFORNIA
 DATE: JUNE, 2013 SCALE: 1" = 1,500'
Carlson, Barbee, & Gibson, Inc.

**FIGURE 17
 NORTHERN SHORELINE
 ZONE OF POTENTIAL DEFORMATION**

system could be constructed in conjunction with the improvement area. An alternative to soil/cement mixing would be construction of a structure, such as a deep bulkhead wall.

There are no corrective measures proposed for the remainder of the northern shoreline adjacent to the Northwest Territories. This area is generally planned for passive open space uses that can accommodate the potential deformations in a seismic event. Any critical or important improvements or amenities planned within the Northwest Territories shall be located outside of the zone of deformation. Otherwise, additional shoreline stability measures will be required in these areas.

b. Liquefaction

i. Liquefiable Soils

Soil liquefaction results from loss of strength during cyclic loading, such as imposed by earthquakes. The previous explorations at the site encountered sand and silty sand deposits that could potentially liquefy under seismic loading. Shallow liquefiable soil is most likely to vent to the surface in the form of sand boils. Sand boils were observed in portions of the Naval Air Station Alameda in the 1989 Loma Prieta Earthquake.

An evaluation of liquefaction potential was performed for the Project Site. The results indicate that sand and silty sand fill material and native deposits are potentially liquefiable down to 40 feet below existing grades. These analyses also indicate that the potentially liquefiable soil could settle as much as 11 inches. A plan showing the depth of liquefiable soil material within the Project Site is provided as Figure 18.

ii. Corrective Measures

The amount of potential liquefaction settlement and lateral spreading are greater than typical structures and infrastructure can tolerate without corrective measures. Ground improvement techniques will likely be necessary to reduce the liquefaction potential of the sandy deposits at the Project Site to levels that improvements can be designed to tolerate. Liquefiable soil can be addressed by either dynamic impact/vibration to densify the soil or mixing with cement to create zones of non-liquefiable soil. The success of dynamic impact methods depends on the fines content of the sand and the depth of the liquefiable material. The following are 4 methods of corrective measures that may be implemented to address liquefiable soils (See detailed descriptions of each of these measures in Appendix A):

- Deep Dynamic Compaction (DDC)
- Rapid Impact Compaction (RIC)
- Vibratory Replacement
- Soil / Cement Mixing

In the Development Areas, DDC will be the most applicable and cost effective liquefaction mitigation method. DDC results in relatively large noise and vibration impacts, so a buffer zone of up to 100 feet will be necessary from any existing structures to minimize impacts. Inside this buffer zone, other ground improvement methods such as rapid impact compaction, vibratory replacement or soil/cement mixing will be implemented.

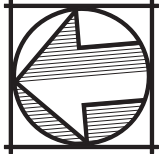
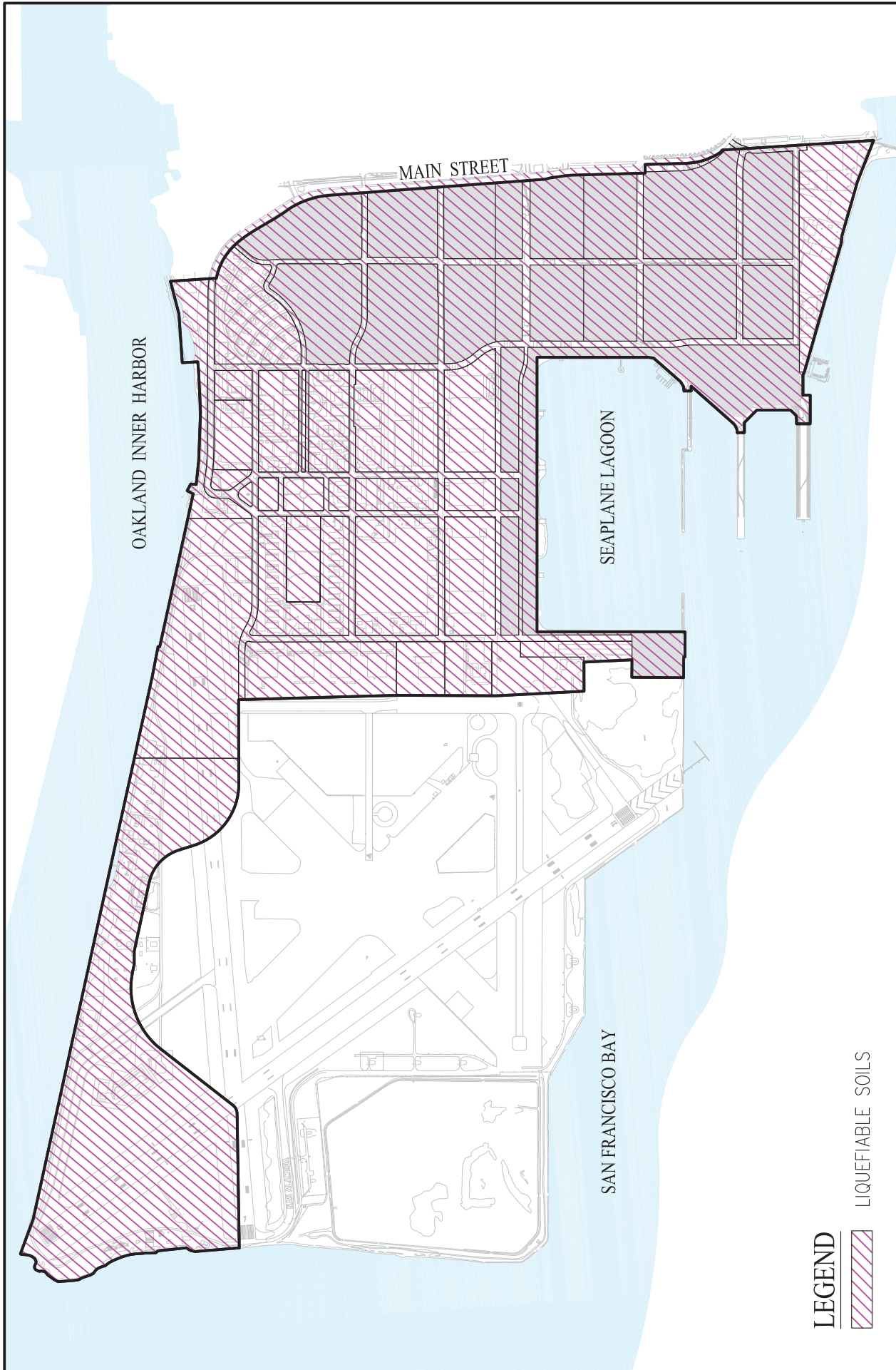

FIGURE 18 LIQUEFIABLE SOILS

ALAMEDA POINT
 MASTER INFRASTRUCTURE PLAN
 CITY OF ALAMEDA ALAMEDA COUNTY CALIFORNIA
 DATE: JUNE, 2013 SCALE: 1" = 1,500'
Carlson, Barbee, & Gibson, Inc.

G:\1087-10\ACAD-10\EXHIBITS\BASE CASE ALT - FIGURES\XB_18_LIQUEFIABLE SOILS.DWG

In the Reuse Areas, liquefaction mitigation measures will be constrained by existing structures and utilities. Ground improvement techniques are not possible for existing buildings; therefore, potential liquefaction induced settlement must be mitigated structurally. Where new utilities are to be installed, RIC could be used to densify the top 15- feet of liquefiable material, and the utilities could be designed to withstand settlement up to 8-inches and differential settlement up to 4-inches. Alternatively, vibratory replacement or soil/cement mixing could be used in these areas to reduce settlement of utilities and other improvements; total and differential settlement using these approaches would be less than using RIC. Based on typical construction costs, ground improvement using RIC will likely be the most cost efficient solution though other ground improvement methods would be more effective in decreasing potential settlement where liquefiable soil is deeper than 15-foot. Existing utilities that will remain in place can be supported by grouting underneath the utility.

c. Compressible Soil

i. Young Bay Mud

Soft, highly compressible Young Bay Mud deposits were encountered in the previous explorations at the Project Site. See Figure 19 depicting the depth of the base of the Young Bay Mud throughout the Project Site. The locations and thicknesses of these deposits are variable, ranging from nil to over 130-feet in thickness. The Young Bay Mud can settle due to loading from any new fill or from new structures constructed at the site. The amount of settlement is a factor of load and thickness of Young Bay Mud. Assuming the Young Bay Mud is normally consolidated, settlement can be as great a ½-foot for each foot of fill placed over the thickest areas of Young Bay Mud. While the majority of settlement from new loads will happen in the first 1 to 2 years after construction, in the areas of the thickest Young Bay Mud, settlement can continue for a period of 50 years or more.

ii. Corrective Measures

Depending on the type of buildings planned at the Project Site, corrective measures of the compressible Young Bay Mud deposits may be feasible. One measure that can be used to mitigate the loading from small, relatively lightweight structures is pre-consolidation of compressible material through a surcharge program. Surcharge fill is placed above design grade elevations in areas of the site where pre-consolidation measures are necessary to reduce settlement. The surcharge fill remains in place for a period sufficient to allow the desired degree of consolidation to be achieved, such that the risk of settlement is sufficiently reduced for the planned structure. Surcharging will induce some settlement in adjacent areas; therefore, it may not be feasible to use surcharge as a compressible soil corrective measure in areas near existing structures and utilities. Likewise, surcharging of initial phases of construction should be placed wider than the footprint of the construction area so that subsequent phases of surcharge do not cause settlement of already constructed areas. Accordingly, surcharge areas of initial phases should be overbuilt by at least 20 feet laterally from the improvement area.

The amount of time necessary to effectively mitigate compressible soil through surcharge is directly related to the thickness of the compressible soil deposit. Where the Young Bay Mud is thicker than about 20 feet, it is likely that wick drains may be desired to shorten

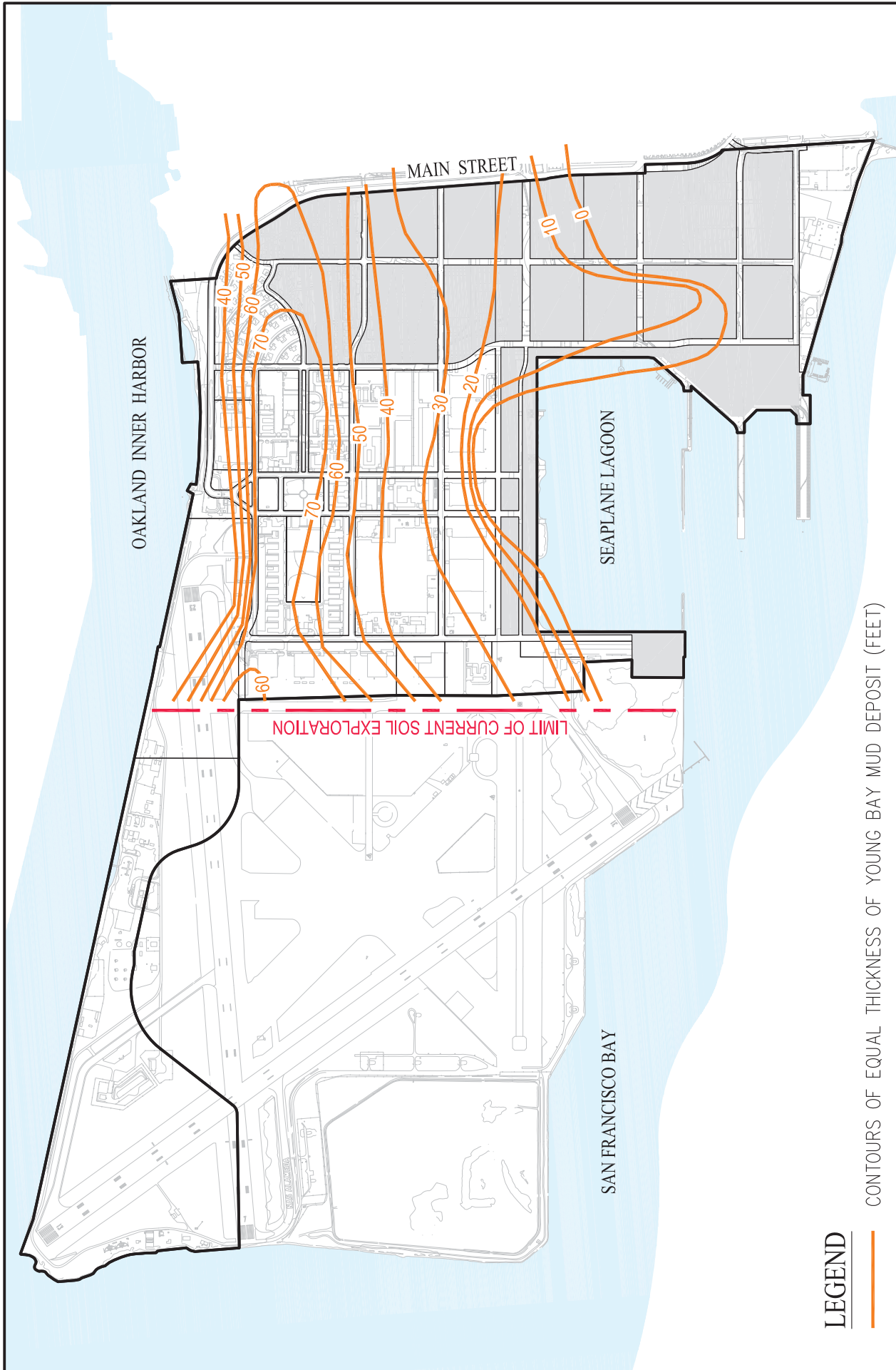

LEGEND

— CONTOURS OF EQUAL THICKNESS OF YOUNG BAY MUD DEPOSIT (FEET)

**ALAMEDA POINT
MASTER INFRASTRUCTURE PLAN**
 CITY OF ALAMEDA ALAMEDA COUNTY CALIFORNIA
 DATE: JUNE, 2013 SCALE: 1" = 1,500'
Carlson, Barbee, & Gibson, Inc.

**FIGURE 19
YOUNG BAY MUD DEPOSITS**

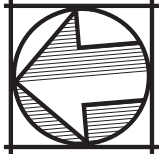

the drainage path of the compressible deposits and accelerate the surcharge program. Wick drains are small drain lines that provide a conduit for the water to escape the Young Bay Mud layer. By doing so, the voids created by the removed water accelerate the consolidation process.

The typical time frames that the surcharge fill is required to be left in place without wick drains can range from 1 to 2 years. Whereas, with the use of wick drains this time frame can be reduced to approximately 6 to 9 months.

A surcharge program is generally not efficient for structures with bearing pressures over 750 to 1,000 pounds per square foot. In these cases deep foundation systems deriving support from below the Young Bay Mud could be suitable at the Project Site. Where deep foundations are used, utilities should incorporate flexible connections as the building will not settle with the surrounding soil.

Outside of the building areas, additional fill from grading to raise the areas above the flooding elevations will also induce consolidation settlement of the Young Bay Mud, and other measures may be necessary to mitigate potential settlement that could adversely affect site improvements (i.e., streets, parking areas, drainage, underground utilities, concrete flatwork, etc.). The selected mitigation will partly depend on what level of risk is acceptable, and could range from:

- Acceptance of settlement risk and periodic maintenance,
- Implementation of a surcharge program to pre-consolidate the soil and Reduce long term settlements,
- Use of lightweight fill as compensation load to reduce settlement or
- Critical utilities could be supported on cement/soil mixed columns.

A surcharge program is anticipated to be implemented in the Development Areas. The surcharge will achieve the amount of pre-consolidation to reduce the risk of settlement associated with the structures and fill material planned for these areas. The surcharge program will include both the building areas, street areas and perimeter flood protection measure areas. This program is intended to eliminate the potential for long term settlement within the Development Areas. Wick drains will be implemented as part of the surcharge program for areas with Young Bay Mud thicker than 20 feet or when surcharge time frames are desired to be accelerated.

New structures proposed within the Reuse Areas will be constructed on a deep foundation system. New utilities will be designed to accommodate the anticipated remaining amount of potential long-term settlement. The design considerations for utilities within these areas include providing flexible joints and/or increased pipe slopes to maintain positive gradients for gravity pipelines should settlement occur. The perimeter flood protection measures surrounding the Reuse Areas will either be surcharged or be supported on a soil/cement mixed corridor.

d. Underground Utilities

i. Utility Trench Shoring & Bedding

Due to the soft nature of the Young Bay Mud, excavations that extend into Young Bay Mud deposits may become unstable. Installation of temporary sheet piles or the use of a shield or continuous hydraulic skeleton shoring should be anticipated for excavations that extend below a depth of about 3 to 5 feet. Additionally, increased pipeline bedding measures will be required in order to achieve a stable foundation for installing the pipeline. This may include a thickened section of base below the pipeline with fabric or other measures as recommended by a geotechnical engineer.

ii. Trench Dewatering

Shallow groundwater is expected at the site and trench excavations may encounter perched groundwater. Therefore, utility trench excavations may require temporary dewatering during construction to keep the excavation and working areas reasonably dry. In general, excavations should be dewatered such that water levels are maintained at least 2 feet below the bottom of the excavation prior to and continuously during shoring installation and the backfill process to control the tendency for the bottom of the excavation to heave under hydrostatic pressures and to reduce inflow of soil or water from beneath temporary shoring. Dewatering for underground utility construction will likely be accomplished by pumping from sumps.

Utility trenches adjacent to existing improvements should include a low permeability cutoff to reduce the risk of inadvertent groundwater flow along permeable bedding or backfill. In these areas dewatering may not be an option; therefore, a relatively impervious shoring system of tight interlocking sheet piles, or other impervious wall type, can be utilized to reduce infiltration during construction.

In addition, possibility of encountering contaminated soil and groundwater should be considered during underground construction and addressed in accordance with the SMP developed for Alameda Point.

C. Value Engineering Opportunities

A value engineering opportunity that could be implemented for the proposed flood protection measures is to minimize the length of the northern shoreline that is proposed to be stabilized. The portion of the northern shoreline adjacent to the Sports Complex where the potential zone of deformation is only 200-foot wide could be maintained in its existing condition. The proposed perimeter flood protection measures would be setback from the zone of potential deformation, approximately 200-feet from the shoreline. Areas exterior to the perimeter flood protection measure will be subject to flooding in high tidal events or with future sea level rise. The improvements of these exterior areas would be passive landscaping that could be converted to tidal wetlands if future sea level rise inundates these areas. Assuming that the length of the Northern Shoreline Stabilization is decreased by 1,500 feet, the backbone infrastructure construction costs would be reduced by approximately \$5.5 million.

Another value engineering opportunity is to allow for the creation of tidal wetlands along the western shoreline of the Seaplane Lagoon. The perimeter flood protection measure could be located at the northwest corner of the Seaplane Lagoon as depicted on Figure 13. The area south of this facility would be allowed to become a tidal wetland as sea levels rise. This area is also adjacent to the other wetlands within the VA Property. Implementing this value engineering opportunity would reduce the backbone infrastructure construction cost by approximately \$10 million

IV. STREET SYSTEM

The City of Alameda adopted a Transportation Element of the General Plan in 2009. The Transportation Element describes various classifications for the street system within Alameda Point based upon the existing street system framework. The MIP proposes a street system framework to enhance the integration of Alameda Point with the circulation and multi-modal elements within the rest of Alameda's street system. The following describes the updates to the Transportation Element to reflect the proposed street system at Alameda Point.

A. Existing On-Site Street System

The existing street system at Alameda Point includes a variety of street types. Street types range from industrial serving streets to residential streets. The framework of the existing streets has multiple connections to Main Street, a regional arterial. The existing system also extends three east-west island arterials into Alameda Point, including Stargell Avenue, West Atlantic Avenue (Ralph Appezato Memorial Parkway) and Pacific Avenue. The framework of the existing system ranges from circuitous areas in the northeast portion of the Project Site to a grid system in the northwest and southeast portions of the site. See Figure 20 depicting the existing street framework within Alameda Point.

The existing street system does not easily facilitate pedestrian and bicycle uses. Not all existing streets include sidewalks and where sidewalks do exist, they are generally narrower than current City standards. In some locations, sidewalks are in poor condition with obvious effects of settlement, resulting in non-accessible paths of travel. The existing paved portions of the streets are usable, but in varying levels of need for rehabilitation. The existing streets have evidence of wear beyond the pavement service life. There are also areas of abandoned rail line crossings that have not been removed or improved. The existing streets require rehabilitation or reconstruction to extend the service life and usability. An important additional consideration is that the existing streetscape and alignments within the Historic District of the Project Site contribute to the historic quality of this resource.

B. Proposed On-Site Street System

The redevelopment of Alameda Point as a proposed transit-oriented community is designed to provide a comprehensive, integrated transportation network that promotes all modes of transportation, emphasizing walking, bicycling and direct and convenient access to high quality transit options. The proposed street system at Alameda Point will be consistent with the City's Complete Street Ordinance (Resolution 14763) to provide for safe, comfortable and convenient travel for all transportation users. The proposed street system facilitates the integration of the historical Reuse Areas within Alameda Point to the surrounding street system in the adjacent portion of Alameda. The proposed street system includes the construction of new streets within the Development Areas and the rehabilitation of existing streets within the Reuse Areas. The proposed framework will maintain the east-west system of island arterials, including Stargell Avenue, Atlantic Avenue, Pacific Avenue and Central Avenue. The proposed street framework is a grid pattern extending the City's street network into the Project Site. See Figure 21 depicting the proposed on-site backbone street system framework within Alameda Point. This figure does not depict the additional in-tract / on-site streets that will be constructed within each development block.

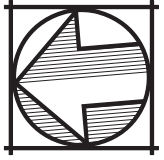
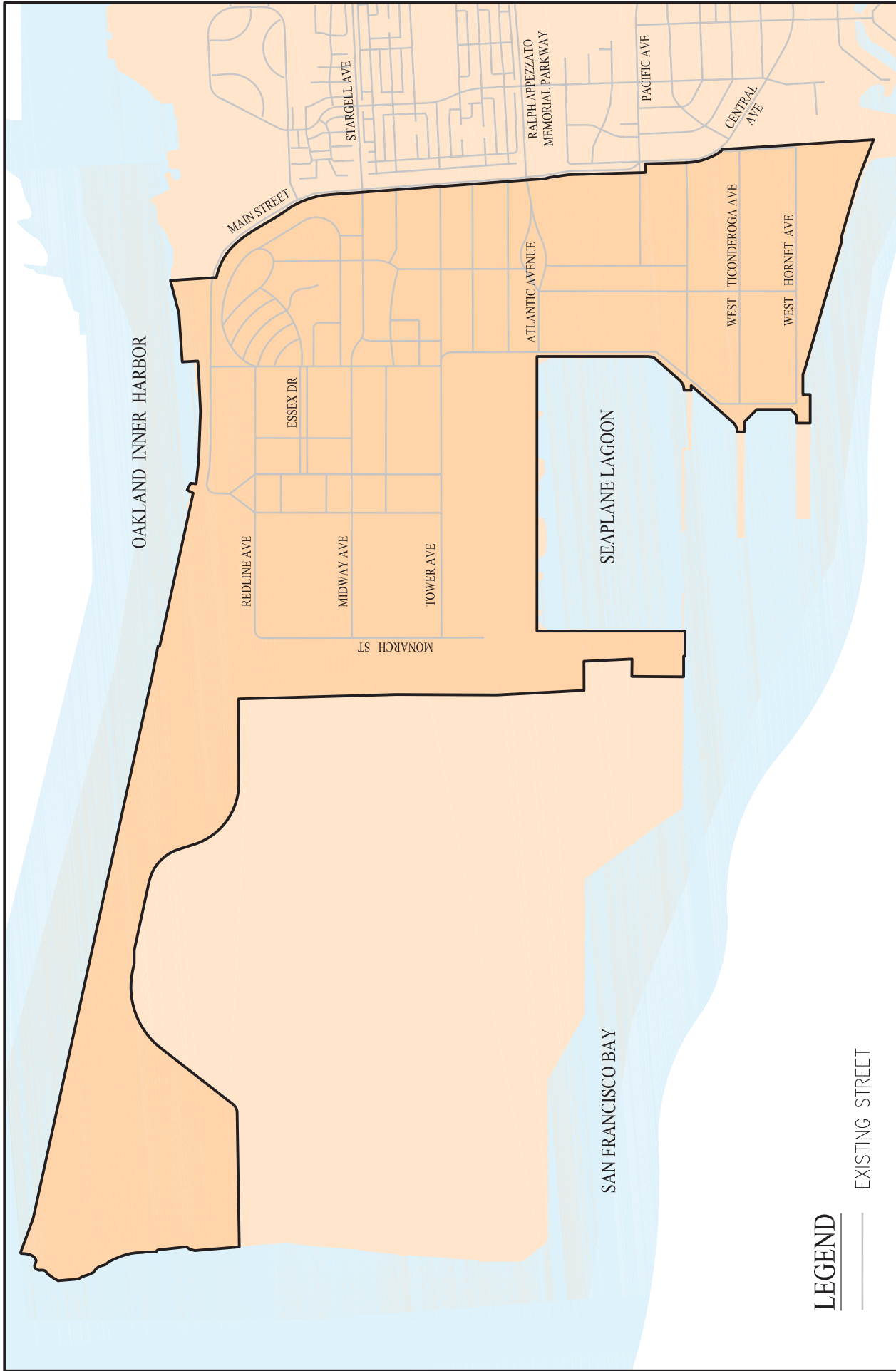

FIGURE 20 EXISTING STREET FRAMEWORK

LEGEND
 ——— EXISTING STREET

**ALAMEDA POINT
 MASTER INFRASTRUCTURE PLAN**
 CITY OF ALAMEDA ALAMEDA COUNTY CALIFORNIA
 DATE: JUNE, 2013 SCALE: 1" = 1,500'
Carlson, Barbee, & Gibson, Inc.

G:\1087-10\ACAD-10\EXHIBITS\BASE CASE ALT - FIGURES\B_20_EX STREET FRAMEWORK.DWG

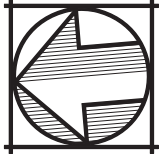
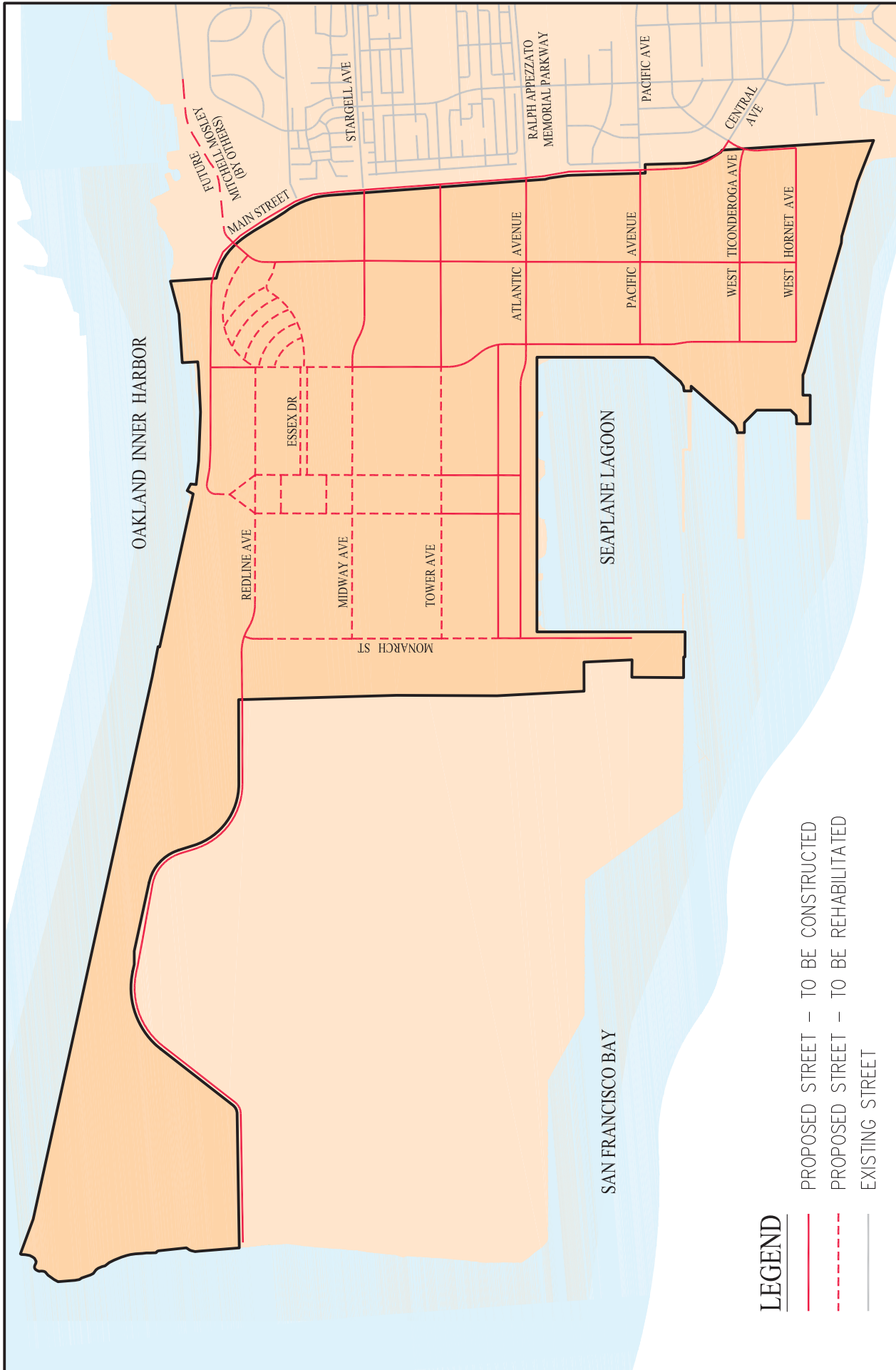

FIGURE 21 PROPOSED STREET FRAMEWORK

- LEGEND**
- TO BE CONSTRUCTED
 - - - TO BE REHABILITATED
 - EXISTING STREET

**ALAMEDA POINT
MASTER INFRASTRUCTURE PLAN**
 CITY OF ALAMEDA ALAMEDA COUNTY CALIFORNIA
 DATE: JUNE, 2013 SCALE: 1" = 1,500'
Carlson, Barbee, & Gibson, Inc.

G:\1087-10ACAD-10EXHIBITS\BASE CASE ALT - FIGURES\B_21_PROPOSED STREET FRAMEWORK.DWG

The proposed street system includes a variety of street classifications. The street classifications are based on those defined in the Transportation Element for the City of Alameda.

1. Street Classifications

The proposed street system includes a Regional Arterial, Island Arterials, Island Collectors and Local Streets. See Figure 22 depicting the proposed street classifications within Alameda Point. The street classifications are established to provide a street system with adequate traffic capacity, bike facilities, transit facilities and truck routes. The street sections of each of these individual street classifications will be finalized through the future planning processes of each Sub-District within Alameda Point. The MIP has prepared draft conceptual street sections as depicted on Figure 23 and Figure 24 to present the transportation components required within each street segment and the proposed widths. The existing street widths within the Reuse Areas will be maintained in order to preserve the historic street grid and streetscapes. The street sections have been designed consistent with “complete streets” principles to facilitate a range of transportation uses. Also, traffic calming features will be provided to improve and promote the pedestrian and bicycle experience.

New streets will be constructed within the Development Areas. This new system of streets will be tree-lined and designed to mirror the patterns and appearance of historic Alameda. See Figure 23 depicting draft conceptual cross sections for the various street classifications within the Development Areas, including Main Street, West Atlantic Ave, Pacific Ave and Orion Street.

The proposed street system will maintain the historic character of the existing streets within the Reuse Areas of the Project Site. In order to accomplish this, the existing width of the streets, from curb to curb, within Reuse Areas will be preserved. The pavement areas will be re-proposed to achieve the objectives of the Project Site street system. Generally, existing travel lanes will be narrowed in order to accommodate Class II bike facilities. See Figure 24 depicting the conceptual street sections for the existing streets within the Reuse Areas. These streets will be rehabilitated including pavement resurfacing, pavement section replacement, sidewalk replacement and accessibility improvements. The rehabilitation of the streets within the Reuse Areas will be completed over time as described in the Phasing and Implementation Section XII.

2. Proposed On-Site Bicycle Facilities

The proposed street system facilitates bicycles a viable mode of transportation. The proposed bicycle priorities for the proposed street system include Class I and Class II facilities throughout the Project Site. Class II facilities may include bike lanes or cycle tracks, depending on adjacent land uses. The proposed bicycle facilities extend those within the other areas of Alameda, providing cross-island bicycle access to Alameda Point. Additionally, the construction of the perimeter Class I facility, Bay Trail, will enhance the recreational bicycle opportunities for the entire Alameda community. See Figure 25 depicting the bicycle facilities proposed as part of the Alameda Point street system.

3. Proposed On-Site Truck Route

The proposed street system includes provisions for a truck route. The proposed truck route will limit the number of streets that through truck traffic is allowed. The proposed truck route will provide sufficient intersection design to allow for truck turning movements and address conflicts with pedestrians and bicycles. Additionally, the travel lane widths within the truck route will be widened up to 12-feet to accommodate trucks. See Figure 26 depicting the truck route proposed as part of the Alameda Point street system.

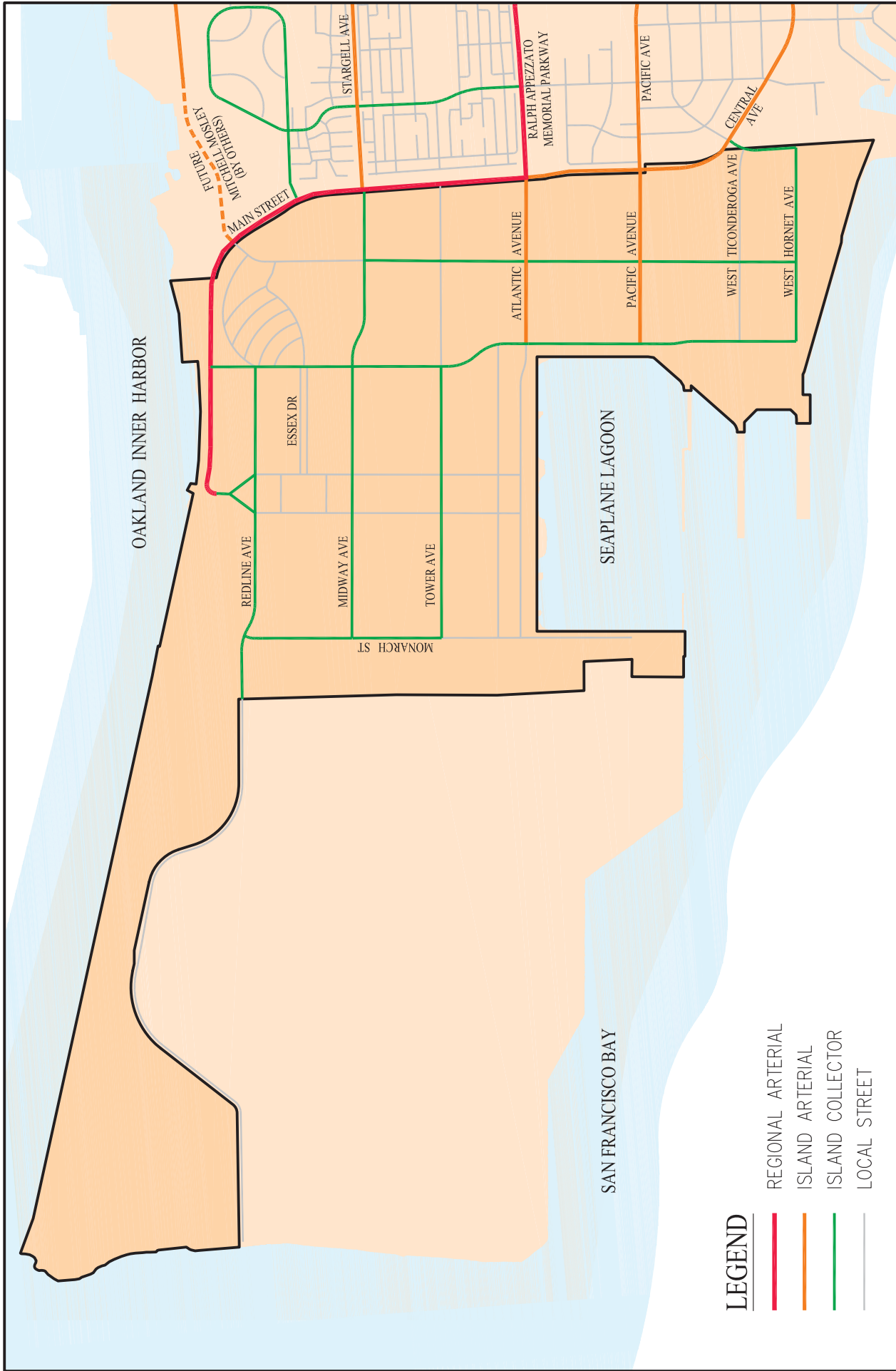

LEGEND

- REGIONAL ARTERIAL
- ISLAND ARTERIAL
- ISLAND COLLECTOR
- LOCAL STREET

**ALAMEDA POINT
MASTER INFRASTRUCTURE PLAN**
CITY OF ALAMEDA ALAMEDA COUNTY CALIFORNIA
DATE: JUNE, 2013 SCALE: 1" = 1,500'
Carlson, Barbee, & Gibson, Inc.

**FIGURE 22
PROPOSED STREET
CLASSIFICATIONS**



G:\1087-10\ACAD-10\EXHIBITS\BASE CASE ALT - FIGURES\WB_22_PROPOSED STREET CLASSIFICATIONS.DWG

STREET CLASSIFICATIONS

CLASSIFICATIONS

- REGIONAL ARTERIAL
- PRIMARY TRANSIT
- TRUCK ROUTE
- CLASS I BIKE LANES

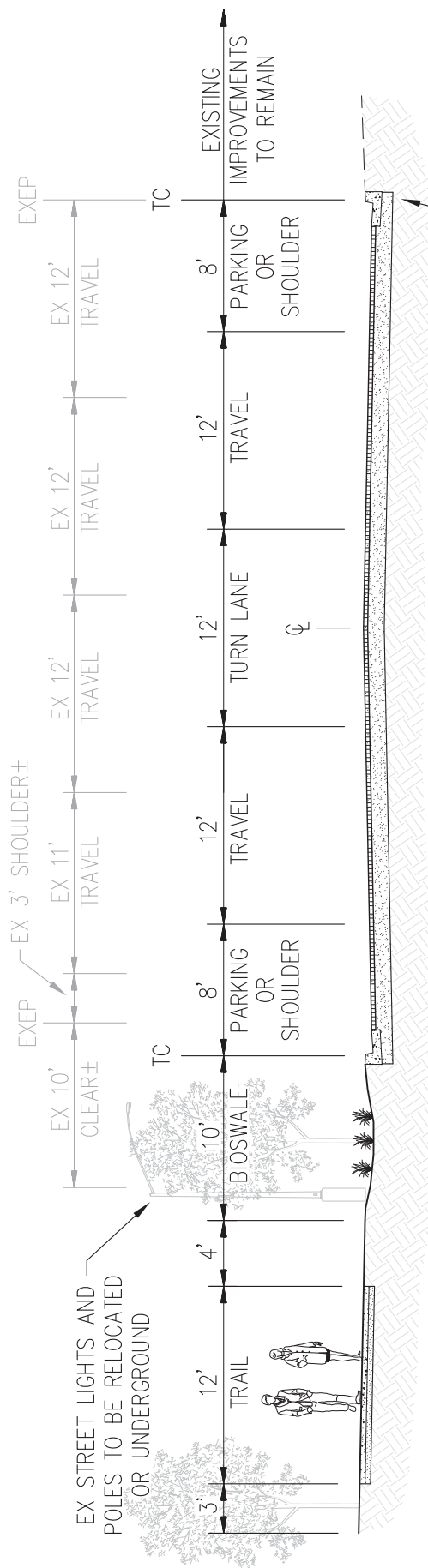
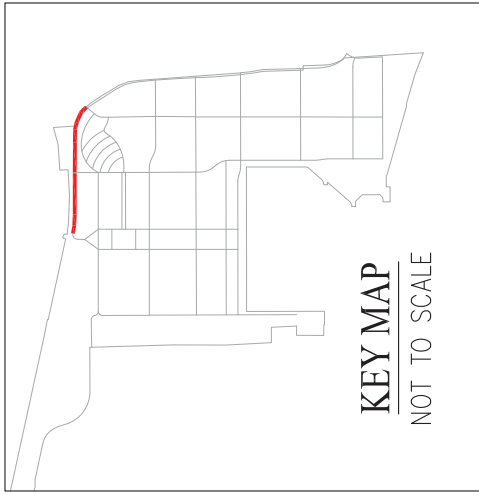

MAIN STREET
REGIONAL ARTERIAL
 MITCHELL MOSLEY TO MAIN GATE

NOTE:
 THIS STREET SECTION IS DRAFT AND PENDING INPUT FROM THE PLANNING BOARD SUBCOMMITTEE REVIEWING STREET SECTION REQUIREMENTS THROUGHOUT THE CITY.



FIGURE 23
MAIN STREET IMPROVEMENTS
DEVELOPMENT AREAS

ALAMEDA POINT
MASTER INFRASTRUCTURE PLAN
 CITY OF ALAMEDA ALAMEDA COUNTY CALIFORNIA
 DATE: JUNE, 2013 NOT TO SCALE
Carlson, Barbee, & Gibson, Inc.

G:\1087-10\CAD-10\EXHIBITS\BASE CASE ALT - FIGURES\B_23_STREET SECTIONS (DEVELOPMENT).DWG

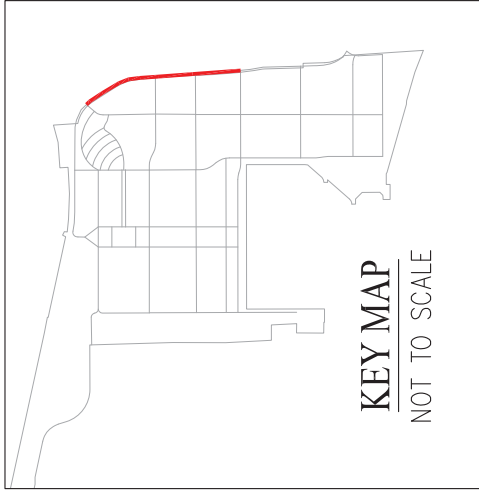

STREET CLASSIFICATIONS

- REGIONAL ARTERIAL
- PRIMARY TRANSIT
- TRUCK ROUTE
- CLASS I BIKE LANES

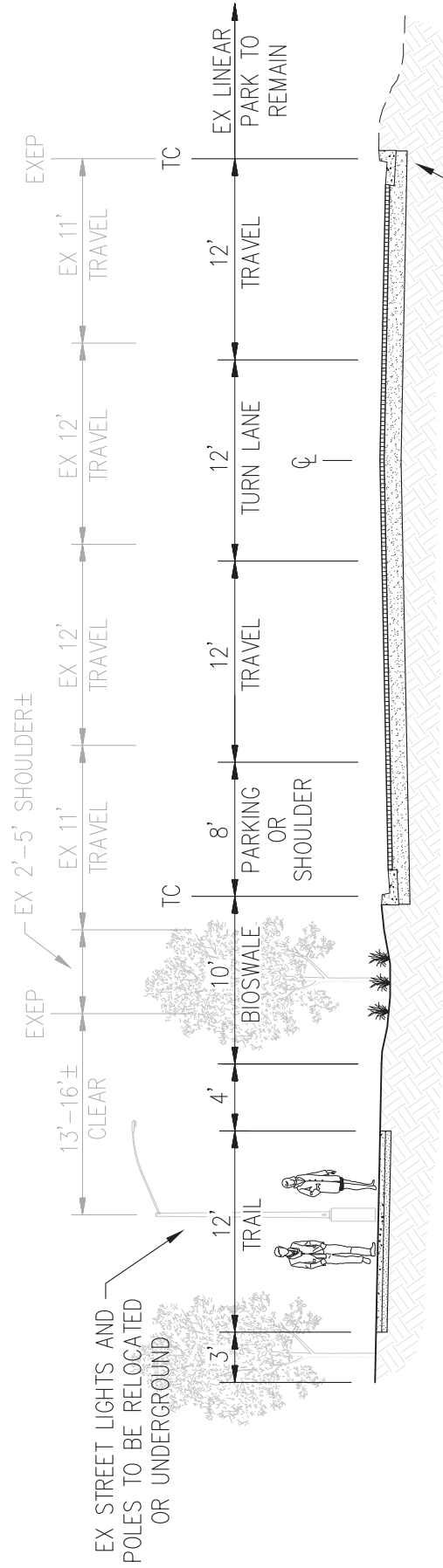

MAIN STREET
REGIONAL ARTERIAL
 ATLANTIC TO MITCHELL MOSLEY
 (NO 115KV POLES)

NOTE:
 THIS STREET SECTION IS DRAFT AND PENDING INPUT FROM THE PLANNING BOARD SUBCOMMITTEE REVIEWING STREET SECTION REQUIREMENTS THROUGHOUT THE CITY.



FIGURE 23
MAIN STREET IMPROVEMENTS
DEVELOPMENT AREAS

ALAMEDA POINT
MASTER INFRASTRUCTURE PLAN
 CITY OF ALAMEDA ALAMEDA COUNTY CALIFORNIA
 DATE: JUNE, 2013 NOT TO SCALE
Carlson, Barbee, & Gibson, Inc.

G:\1087-10\ACAD-10\EXHIBITS\BASE CASE ALT - FIGURES\XB_23_STREET SECTIONS (DEVELOPMENT).DWG

STREET CLASSIFICATIONS

- REGIONAL ARTERIAL
- PRIMARY TRANSIT
- TRUCK ROUTE
- CLASS I BIKE LANES

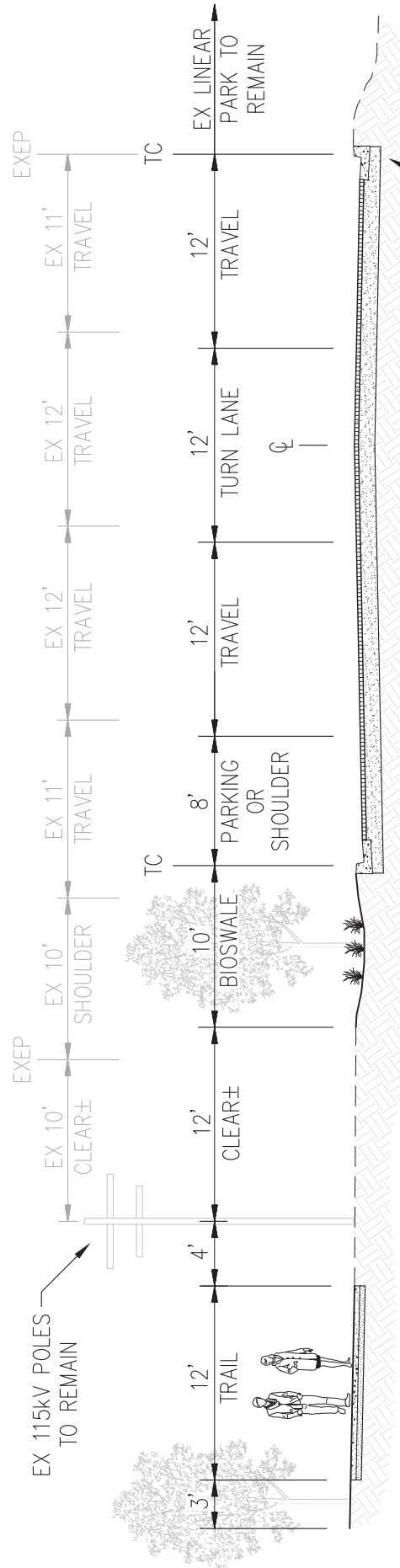
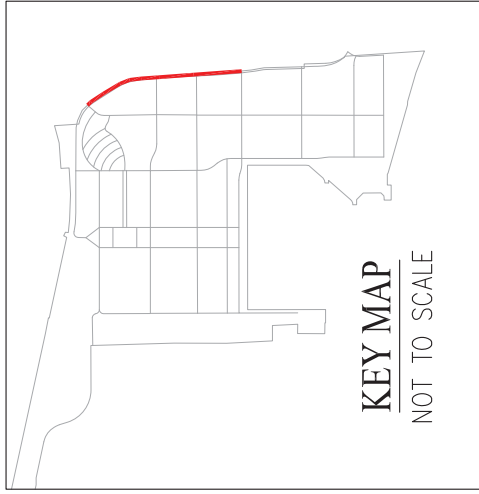

MAIN STREET
REGIONAL ARTERIAL
ATLANTIC TO MITCHELL MOSLEY
(WITH 115kV POLES)

NOTE:
THIS STREET SECTION IS DRAFT AND PENDING INPUT FROM THE PLANNING BOARD SUBCOMMITTEE REVIEWING STREET SECTION REQUIREMENTS THROUGHOUT THE CITY.

MATCH EXISTING EDGE OF PAVEMENT

ALAMEDA POINT
MASTER INFRASTRUCTURE PLAN
CITY OF ALAMEDA ALAMEDA COUNTY CALIFORNIA
DATE: JUNE, 2013 NOT TO SCALE
Carlson, Barbee, & Gibson, Inc.

FIGURE 23
MAIN STREET IMPROVEMENTS
DEVELOPMENT AREAS



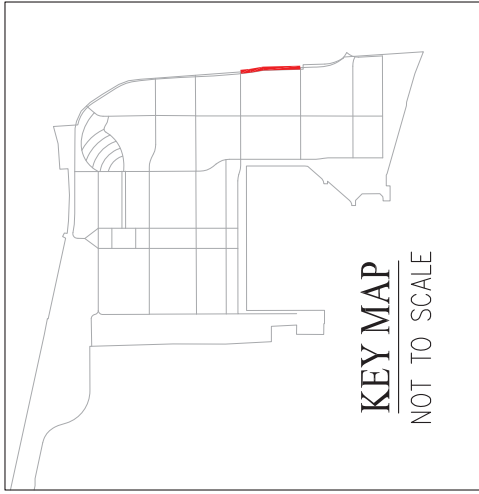

- STREET CLASSIFICATIONS**
- ISLAND ARTERIAL
 - PRIMARY TRANSIT
 - TRUCK ROUTE
 - CLASS I BIKE LANES

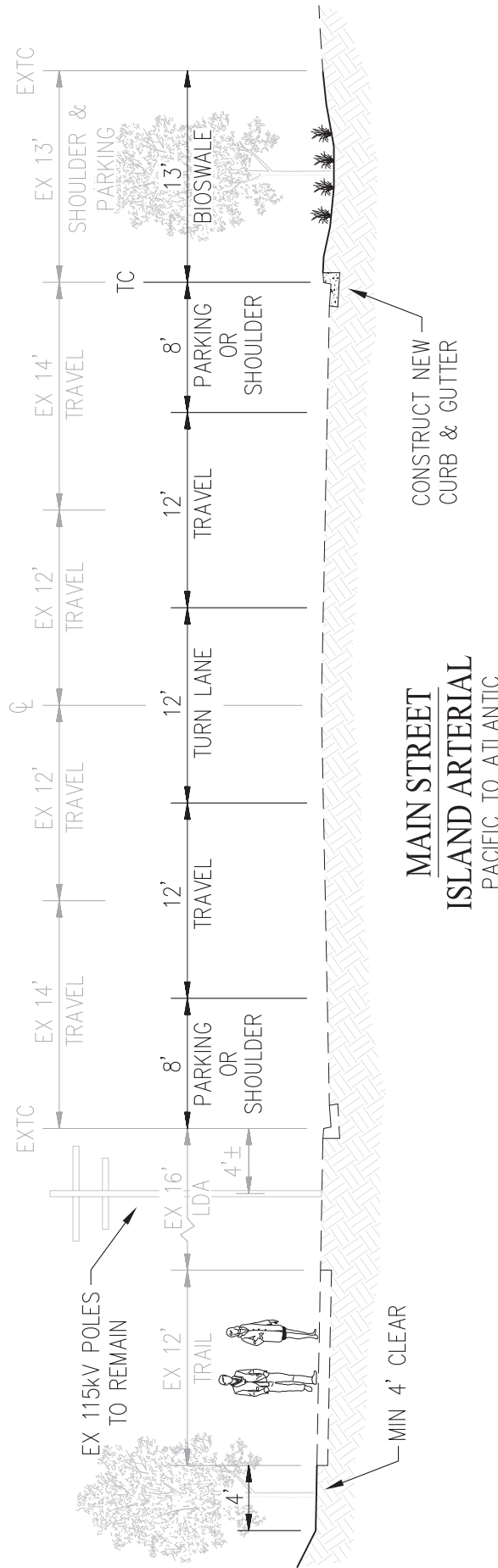

NOTE:
 THIS STREET SECTION IS DRAFT AND PENDING INPUT FROM THE PLANNING BOARD SUBCOMMITTEE REVIEWING STREET SECTION REQUIREMENTS THROUGHOUT THE CITY.

ALAMEDA POINT
 MASTER INFRASTRUCTURE PLAN
 CITY OF ALAMEDA ALAMEDA COUNTY CALIFORNIA
 DATE: JUNE, 2013 NOT TO SCALE
 Carlson, Barbee, & Gibson, Inc.

FIGURE 23
 MAIN STREET IMPROVEMENTS
 DEVELOPMENT AREAS

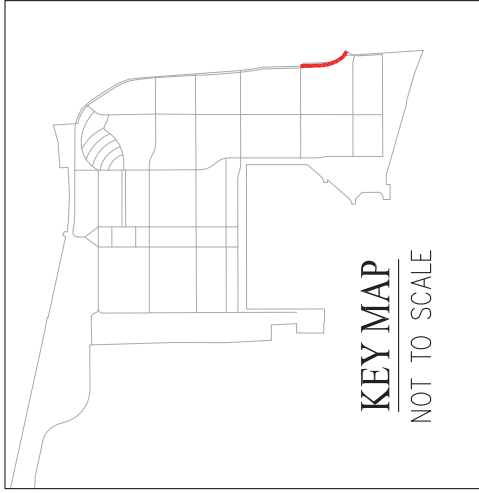

STREET CLASSIFICATIONS

- ISLAND ARTERIAL
- PRIMARY TRANSIT
- TRUCK ROUTE
- CLASS I BIKE LANES

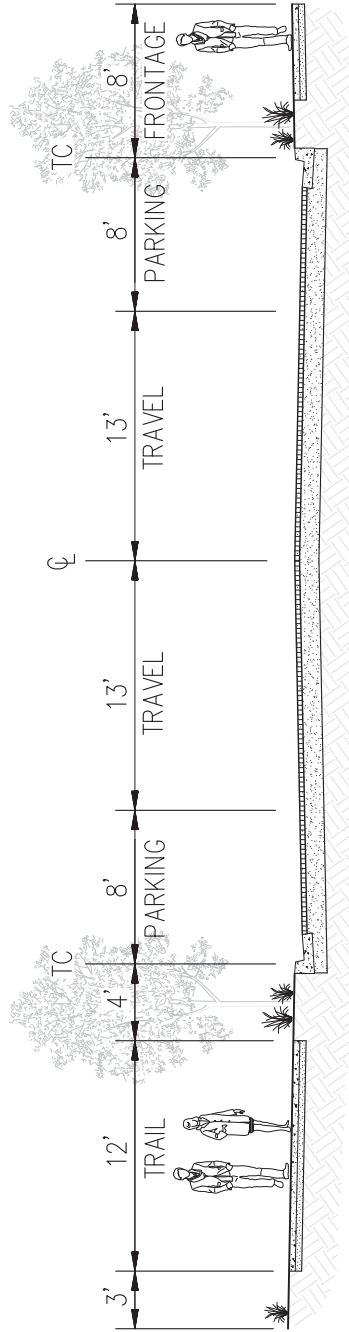

CENTRAL AVENUE
ISLAND ARTERIAL
MATCH EXISTING CONDITION
AT LINCOLN TO PACIFIC

NOTE:
THIS STREET SECTION IS DRAFT AND PENDING INPUT FROM THE PLANNING BOARD SUBCOMMITTEE REVIEWING STREET SECTION REQUIREMENTS THROUGHOUT THE CITY.

ALAMEDA POINT
MASTER INFRASTRUCTURE PLAN
CITY OF ALAMEDA ALAMEDA COUNTY CALIFORNIA
DATE: JUNE, 2013 NOT TO SCALE
Carlson, Barbee, & Gibson, Inc.

FIGURE 23
CENTRAL AVENUE IMPROVEMENTS
DEVELOPMENT AREAS



STREET CLASSIFICATIONS

- ISLAND ARTERIAL
- EXCLUSIVE RIGHT-OF-WAY (RBS / BRT)
- CLASS I & II BIKE LANES

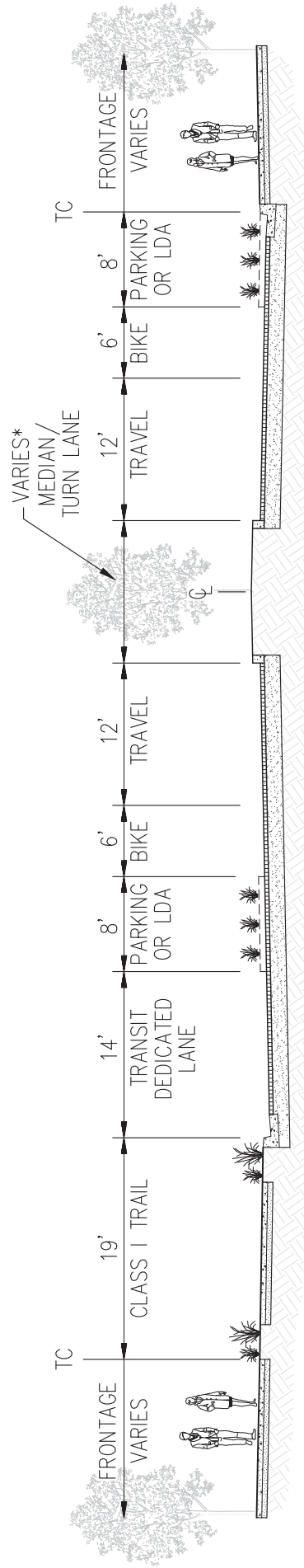
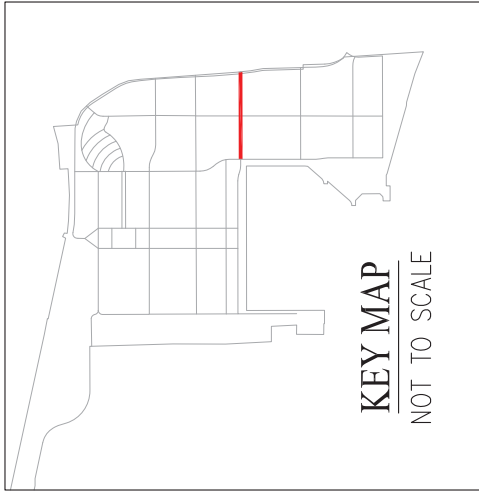

**WEST ATLANTIC
ISLAND ARTERIAL**

MEDIAN NOTE:
EXISTING OVAL MEDIAN COULD BE MAINTAINED.

NOTE:
THIS STREET SECTION IS DRAFT AND PENDING INPUT FROM THE PLANNING BOARD SUBCOMMITTEE REVIEWING STREET SECTION REQUIREMENTS THROUGHOUT THE CITY.

ALAMEDA POINT
MASTER INFRASTRUCTURE PLAN
 CITY OF ALAMEDA ALAMEDA COUNTY CALIFORNIA
 DATE: JUNE, 2013 NOT TO SCALE
Carlson, Barbee, & Gibson, Inc.

FIGURE 23
WEST ATLANTIC IMPROVEMENTS
DEVELOPMENT AREAS

STREET CLASSIFICATIONS

- ISLAND ARTERIAL
- PRIMARY TRANSIT
- TRUCK ROUTE
- CLASS II BIKE LANES

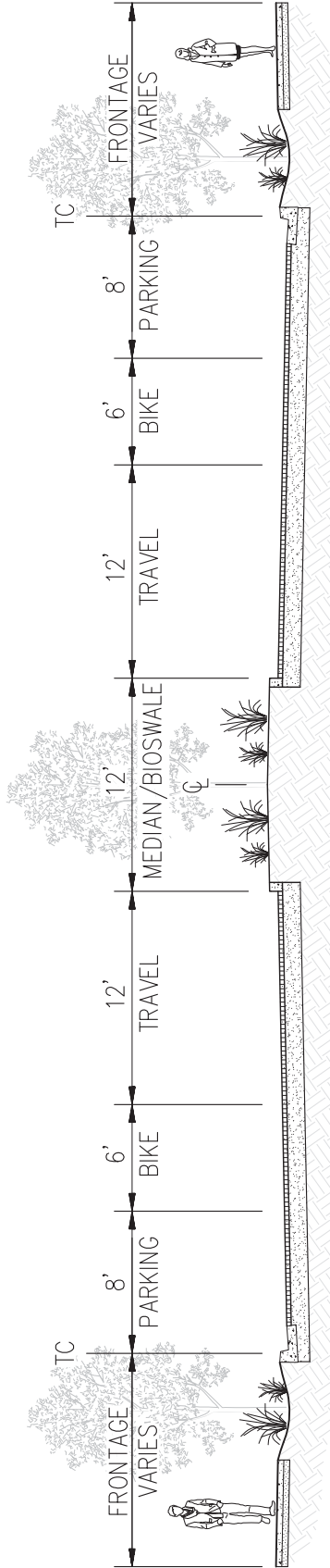
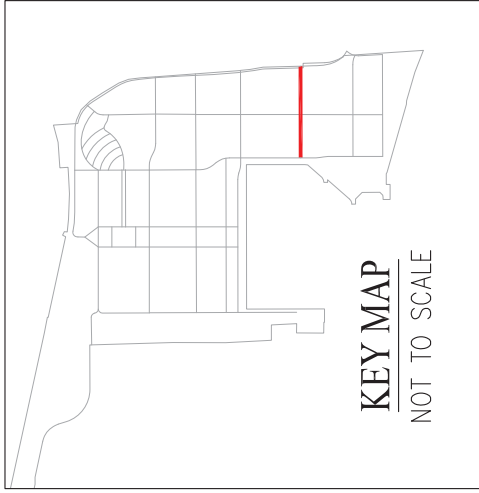

PACIFIC AVENUE
ISLAND ARTERIAL

NOTE:

THIS STREET SECTION IS DRAFT AND PENDING INPUT FROM THE PLANNING BOARD SUBCOMMITTEE REVIEWING STREET SECTION REQUIREMENTS THROUGHOUT THE CITY.

ALAMEDA POINT
MASTER INFRASTRUCTURE PLAN
CITY OF ALAMEDA ALAMEDA COUNTY CALIFORNIA
DATE: JUNE, 2013 NOT TO SCALE
Carlson, Barbee, & Gibson, Inc.

FIGURE 23
PACIFIC AVENUE IMPROVEMENTS
DEVELOPMENT AREAS

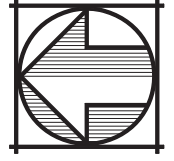

STREET

CLASSIFICATIONS

- ISLAND COLLECTOR
- PRIMARY/SECONDARY/OTHER TRANSIT (VARIES)
- TRUCK ROUTE (VARIES)
- CLASS II BIKE LANES

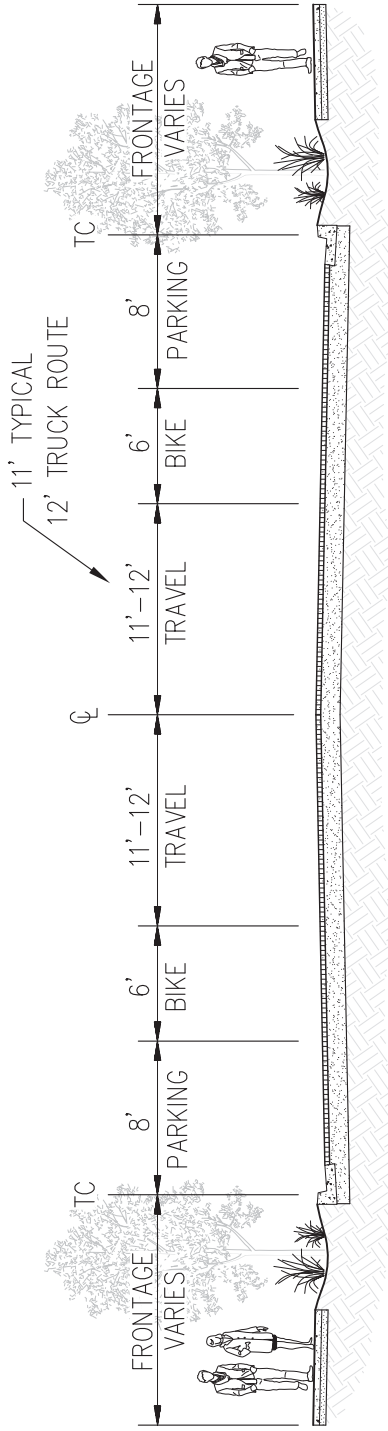
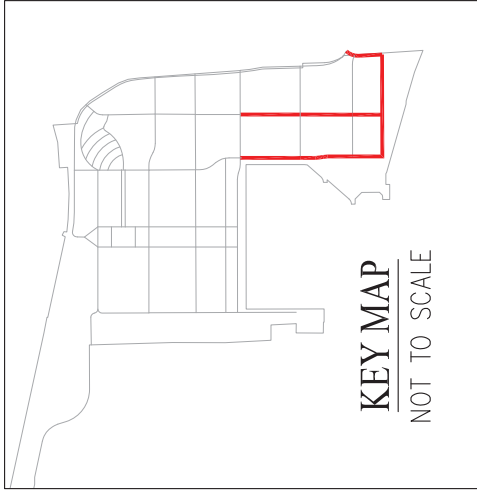

**ISLAND COLLECTOR
COMMERCIAL**

TRAFFIC CALMING NOTE:

TRAFFIC CALMING MEASURES (I.E. CURB BULB-OUTS) TO BE INCORPORATED.

NOTE:

THIS STREET SECTION IS DRAFT AND PENDING INPUT FROM THE PLANNING BOARD SUBCOMMITTEE REVIEWING STREET SECTION REQUIREMENTS THROUGHOUT THE CITY.

**ALAMEDA POINT
MASTER INFRASTRUCTURE PLAN**
CITY OF ALAMEDA ALAMEDA COUNTY CALIFORNIA
DATE: JUNE, 2013 NOT TO SCALE
Carlson, Barbee, & Gibson, Inc.

**FIGURE 23
ISLAND COLLECTORS
DEVELOPMENT AREAS**



STREET

CLASSIFICATIONS

- ISLAND COLLECTOR
- PRIMARY/SECONDARY/OTHER TRANSIT (VARIES)
- TRUCK ROUTE (VARIES)
- CLASS II BIKE LANES

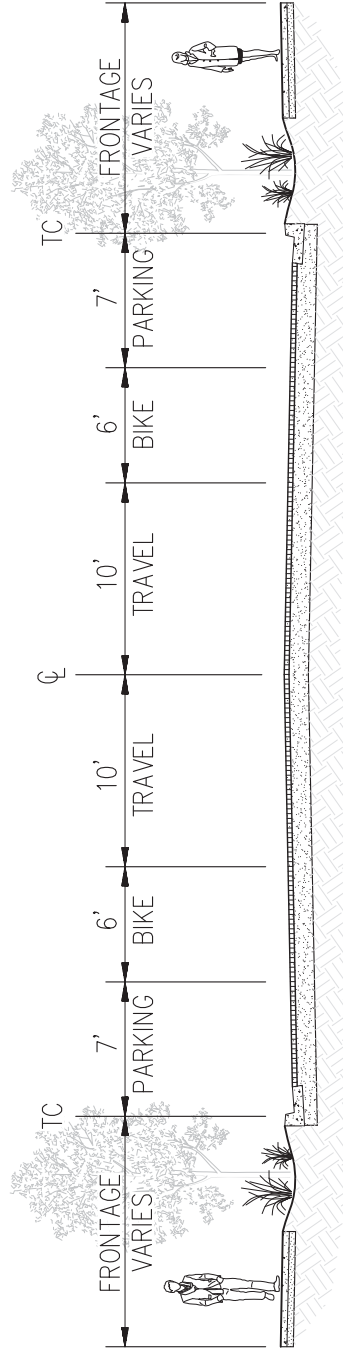
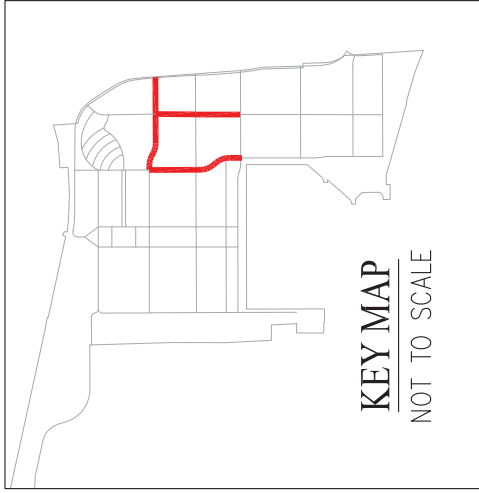

**ISLAND COLLECTOR
RESIDENTIAL**

TRAFFIC CALMING NOTE:

TRAFFIC CALMING MEASURES (I.E. CURB BULB-OUTS) TO BE INCORPORATED.

NOTE:

THIS STREET SECTION IS DRAFT AND PENDING INPUT FROM THE PLANNING BOARD SUBCOMMITTEE REVIEWING STREET SECTION REQUIREMENTS THROUGHOUT THE CITY.

**FIGURE 23
ISLAND COLLECTORS
DEVELOPMENT AREAS**

**ALAMEDA POINT
MASTER INFRASTRUCTURE PLAN**
CITY OF ALAMEDA ALAMEDA COUNTY CALIFORNIA
DATE: JUNE, 2013 NOT TO SCALE
Carlson, Barbee, & Gibson, Inc.



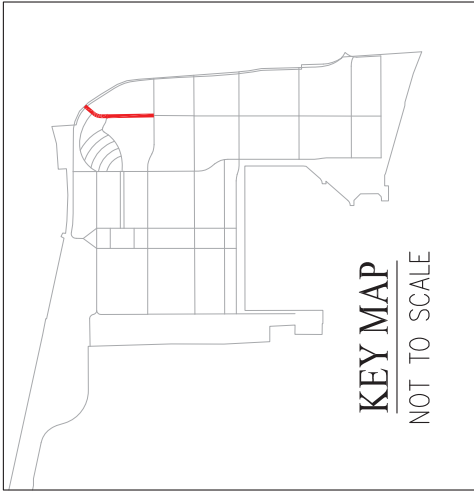

STREET CLASSIFICATIONS

- LOCAL STREET
- CLASS II BIKE LANES

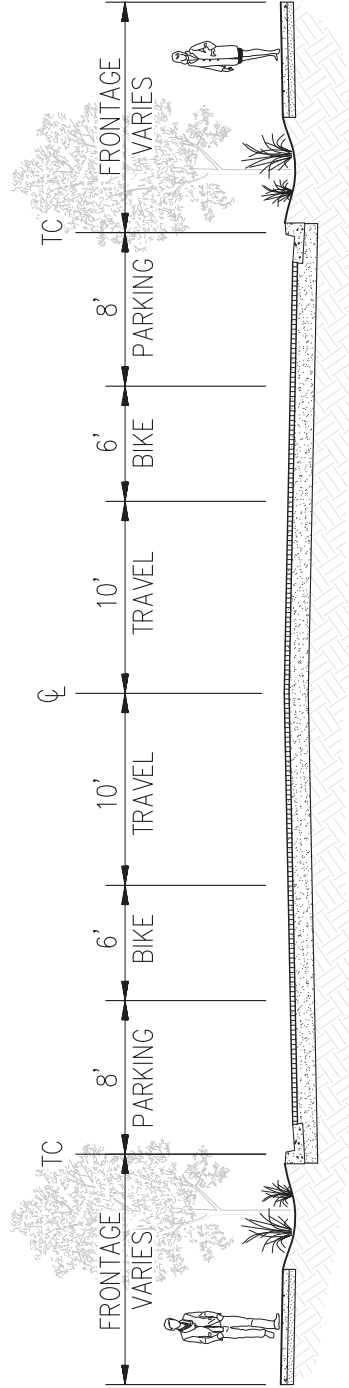

**LOCAL STREETS
RESIDENTIAL**

NOTE:

THIS STREET SECTION IS DRAFT AND PENDING INPUT FROM THE PLANNING BOARD SUBCOMMITTEE REVIEWING STREET SECTION REQUIREMENTS THROUGHOUT THE CITY.

**ALAMEDA POINT
MASTER INFRASTRUCTURE PLAN**
CITY OF ALAMEDA ALAMEDA COUNTY CALIFORNIA
DATE: JUNE, 2013 NOT TO SCALE
Carlson, Barbee, & Gibson, Inc.

**FIGURE 23
LOCAL STREETS
DEVELOPMENT AREAS**

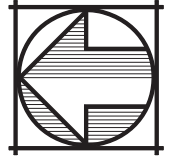

STREET CLASSIFICATIONS

- LOCAL STREET

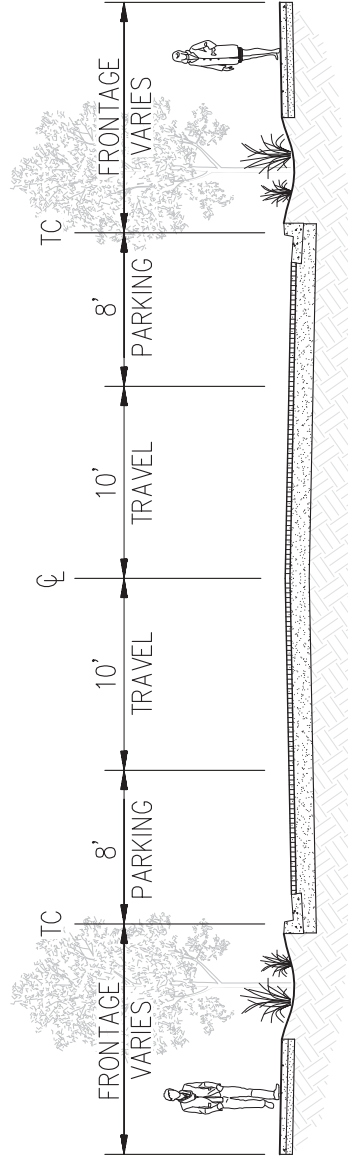
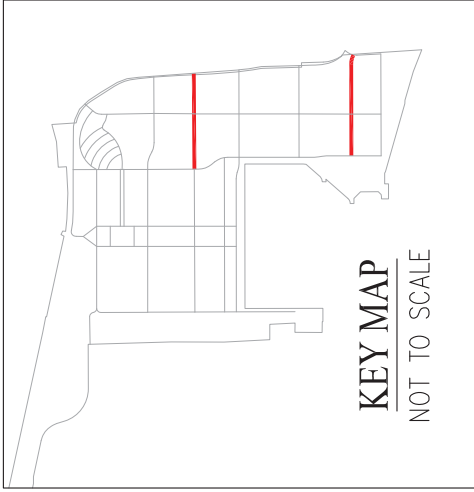

**LOCAL STREETS
COMMERCIAL & RESIDENTIAL**

NOTE:
THIS STREET SECTION IS DRAFT AND PENDING INPUT FROM THE PLANNING BOARD SUBCOMMITTEE REVIEWING STREET SECTION REQUIREMENTS THROUGHOUT THE CITY.

**ALAMEDA POINT
MASTER INFRASTRUCTURE PLAN**
CITY OF ALAMEDA ALAMEDA COUNTY CALIFORNIA
DATE: JUNE, 2013 NOT TO SCALE
Carlson, Barbee, & Gibson, Inc.

**FIGURE 23
LOCAL STREETS
DEVELOPMENT AREAS**

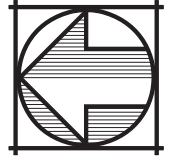

NOTE:

THIS STREET SECTION IS DRAFT AND PENDING INPUT FROM THE PLANNING BOARD SUBCOMMITTEE REVIEWING STREET SECTION REQUIREMENTS THROUGHOUT THE CITY.

STREET CLASSIFICATIONS

- ISLAND COLLECTOR
- TRUCK ROUTE
- CLASS II BIKE LANES

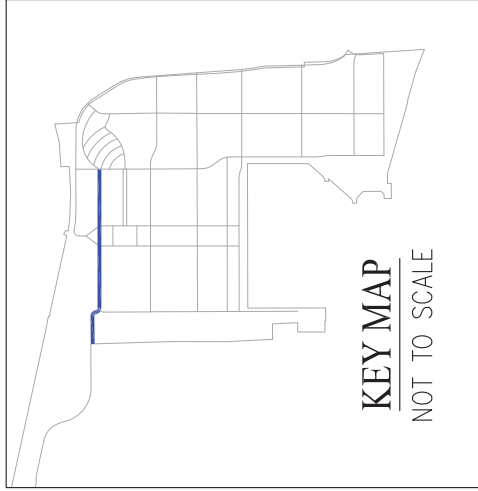

EXISTING CONDITIONS

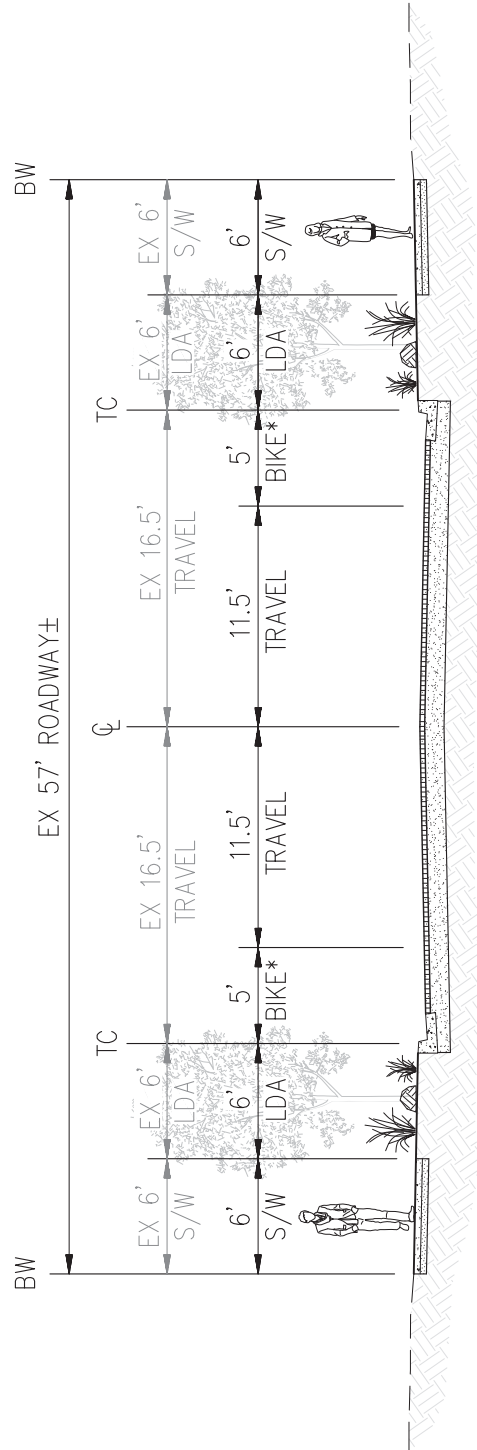

BIKE NOTE:

5' BIKE LANE CONSISTENT WITH TABLE 2 IN BICYCLE FACILITY DESIGN STANDARDS

RETROFITTED CROSS-SECTION

ALAMEDA POINT MASTER INFRASTRUCTURE PLAN
CITY OF ALAMEDA ALAMEDA COUNTY CALIFORNIA
DATE: JUNE, 2013 NOT TO SCALE
Carlson, Barbee, & Gibson, Inc.

FIGURE 24 WEST REDLINE AVENUE REUSE AREAS

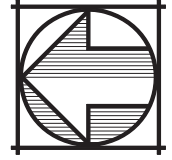

NOTE:

THIS STREET SECTION IS DRAFT AND PENDING INPUT FROM THE PLANNING BOARD SUBCOMMITTEE REVIEWING STREET SECTION REQUIREMENTS THROUGHOUT THE CITY.

STREET CLASSIFICATIONS

- LOCAL STREET

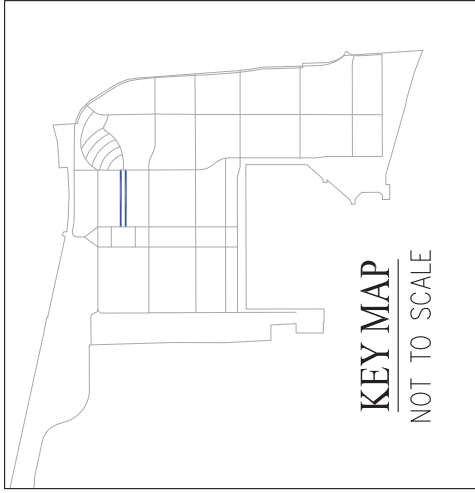

EXISTING CONDITIONS

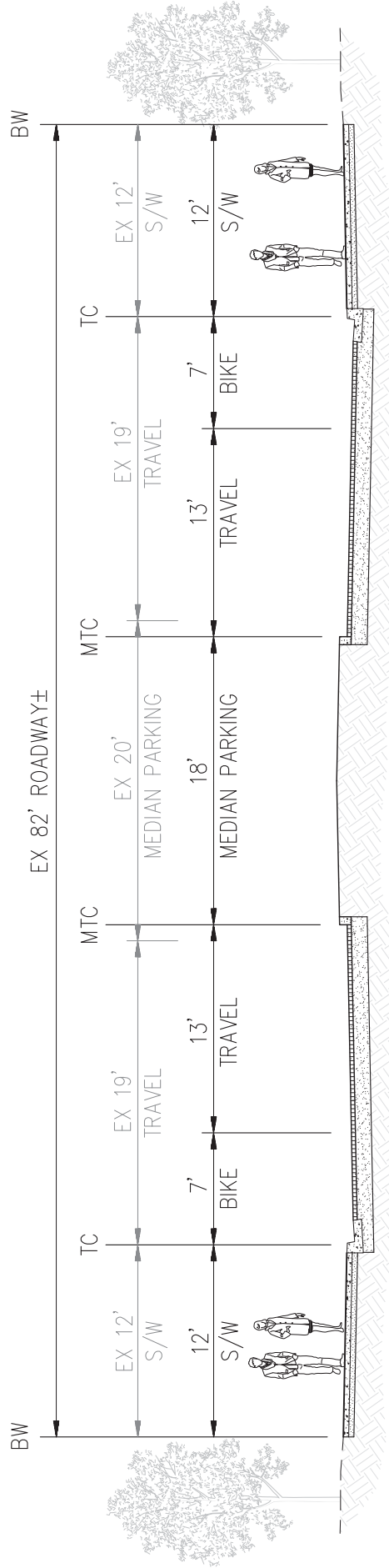

RETROFITTED CROSS-SECTION

ALAMEDA POINT
MASTER INFRASTRUCTURE PLAN
 CITY OF ALAMEDA ALAMEDA COUNTY CALIFORNIA
 DATE: JUNE, 2013 NOT TO SCALE
Carlson, Barbee, & Gibson, Inc.

FIGURE 24
ESSEX DRIVE
REUSE AREAS



NOTE:

THIS STREET SECTION IS DRAFT AND PENDING INPUT FROM THE PLANNING BOARD SUBCOMMITTEE REVIEWING STREET SECTION REQUIREMENTS THROUGHOUT THE CITY.

STREET CLASSIFICATIONS

- ISLAND COLLECTOR
- CLASS II BIKE LANES
- PRIMARY TRANSIT STREET

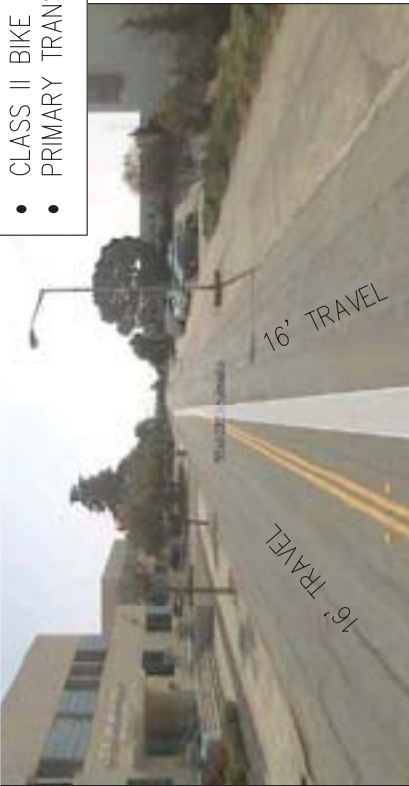

EXISTING CONDITIONS (WEST)

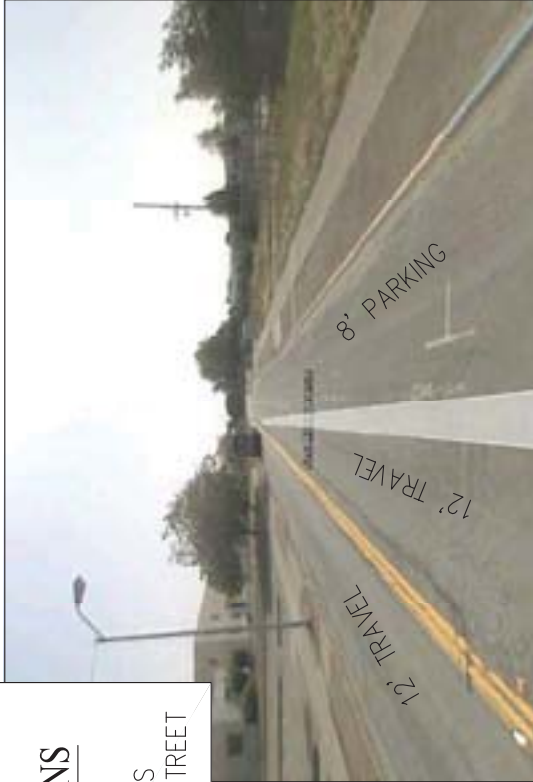

EXISTING CONDITIONS (EAST)

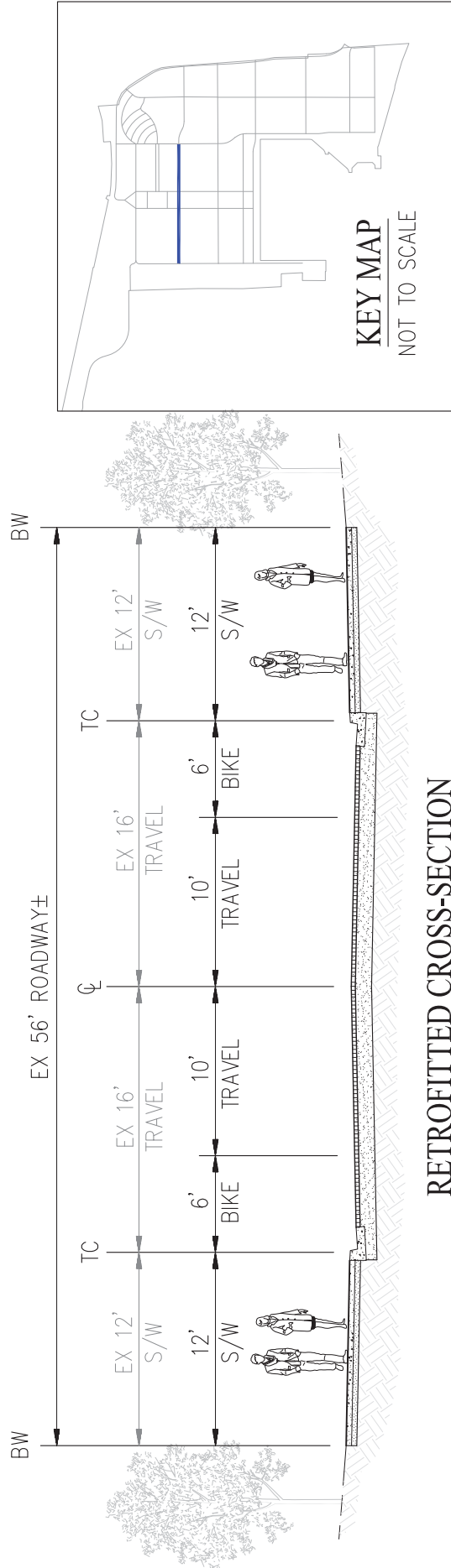

ALAMEDA POINT
MASTER INFRASTRUCTURE PLAN
 CITY OF ALAMEDA ALAMEDA COUNTY CALIFORNIA
 DATE: JUNE, 2013 NOT TO SCALE
Carlson, Barbee, & Gibson, Inc.

FIGURE 24
WEST MIDWAY AVENUE
REUSE AREAS



NOTE:

THIS STREET SECTION IS DRAFT AND PENDING INPUT FROM THE PLANNING BOARD SUBCOMMITTEE REVIEWING STREET SECTION REQUIREMENTS THROUGHOUT THE CITY.

STREET CLASSIFICATIONS

- ISLAND COLLECTOR
- TRUCK ROUTE
- CLASS II BIKE LANES

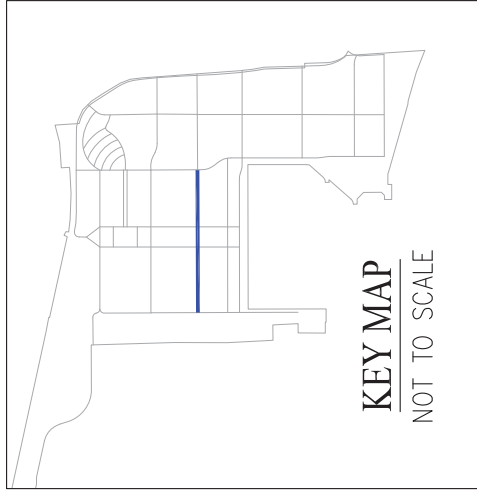

EXISTING CONDITIONS

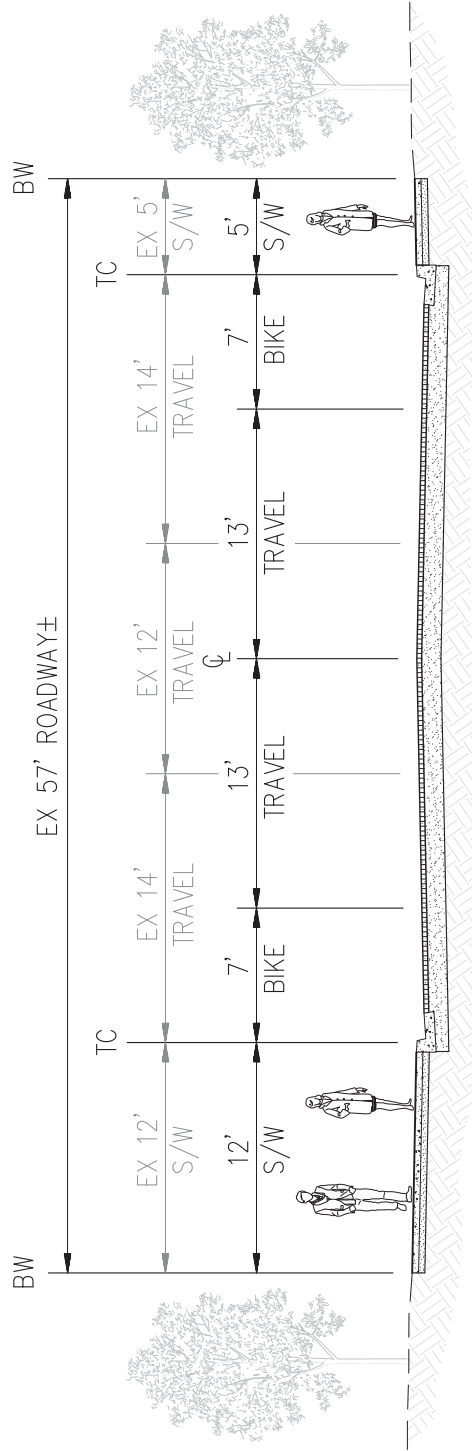

RETROFITTED CROSS-SECTION

ALAMEDA POINT
MASTER INFRASTRUCTURE PLAN
 CITY OF ALAMEDA ALAMEDA COUNTY CALIFORNIA
 DATE: JUNE, 2013 NOT TO SCALE
Carlson, Barbee, & Gibson, Inc.

**FIGURE 24
 TOWER AVENUE
 REUSE AREAS**



NOTE:

THIS STREET SECTION IS DRAFT AND PENDING INPUT FROM THE PLANNING BOARD SUBCOMMITTEE REVIEWING STREET SECTION REQUIREMENTS THROUGHOUT THE CITY.

STREET

CLASSIFICATIONS

- ISLAND COLLECTOR
- TRUCK ROUTE
- CLASS II BIKE LANES

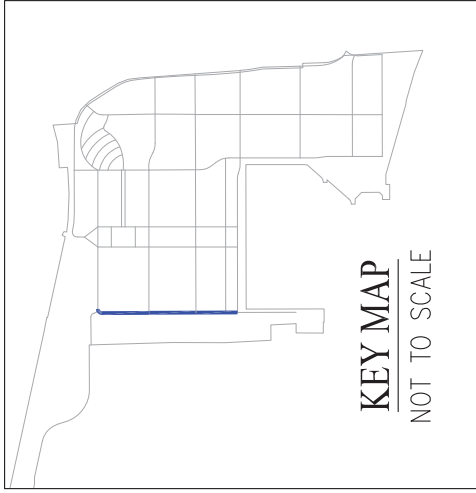

EXISTING CONDITIONS

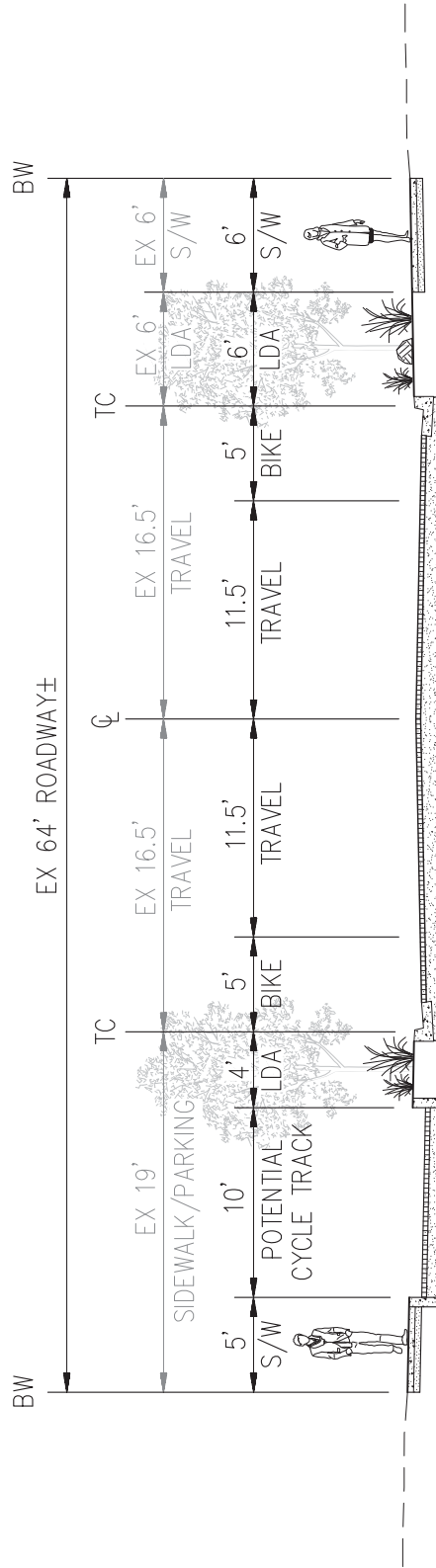

RETROFITTED CROSS-SECTION

ALAMEDA POINT
MASTER INFRASTRUCTURE PLAN
 CITY OF ALAMEDA ALAMEDA COUNTY CALIFORNIA
 DATE: JUNE, 2013 NOT TO SCALE
Carlson, Barbee, & Gibson, Inc.

FIGURE 24
MONARCH STREET
REUSE AREAS

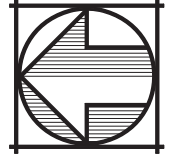

NOTE:

THIS STREET SECTION IS DRAFT AND PENDING INPUT FROM THE PLANNING BOARD SUBCOMMITTEE REVIEWING STREET SECTION REQUIREMENTS THROUGHOUT THE CITY.

STREET CLASSIFICATIONS

- LOCAL STREET
- CLASS II BIKE LANES
- SECONDARY TRANSIT STREET

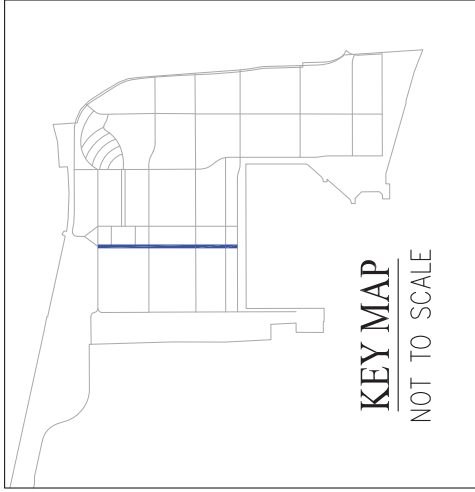

EXISTING CONDITIONS

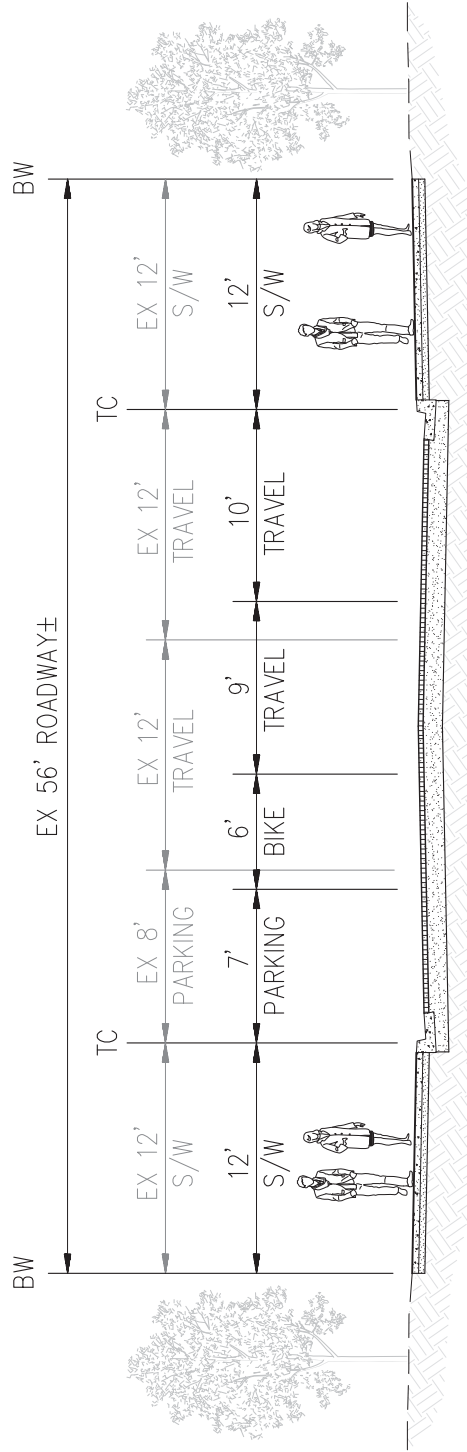

RETROFITTED CROSS-SECTION

ALAMEDA POINT MASTER INFRASTRUCTURE PLAN
CITY OF ALAMEDA ALAMEDA COUNTY CALIFORNIA
DATE: JUNE, 2013 NOT TO SCALE
Carlson, Barbee, & Gibson, Inc.

FIGURE 24 LEXINGTON STREET REUSE AREAS

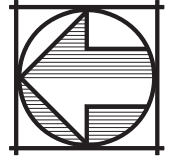

NOTE:

THIS STREET SECTION IS DRAFT AND PENDING INPUT FROM THE PLANNING BOARD SUBCOMMITTEE REVIEWING STREET SECTION REQUIREMENTS THROUGHOUT THE CITY.

STREET CLASSIFICATIONS

- LOCAL STREET
- PRIMARY TRANSIT STREET

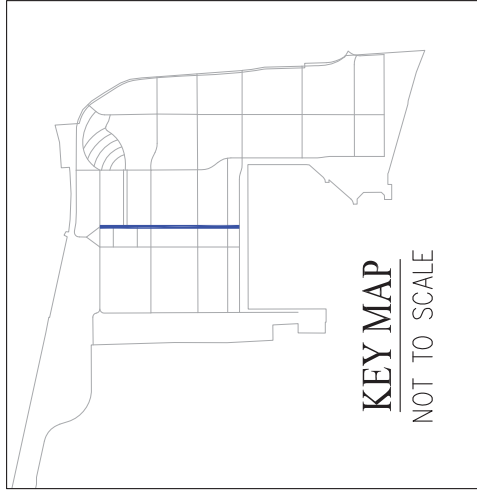

EXISTING CONDITIONS

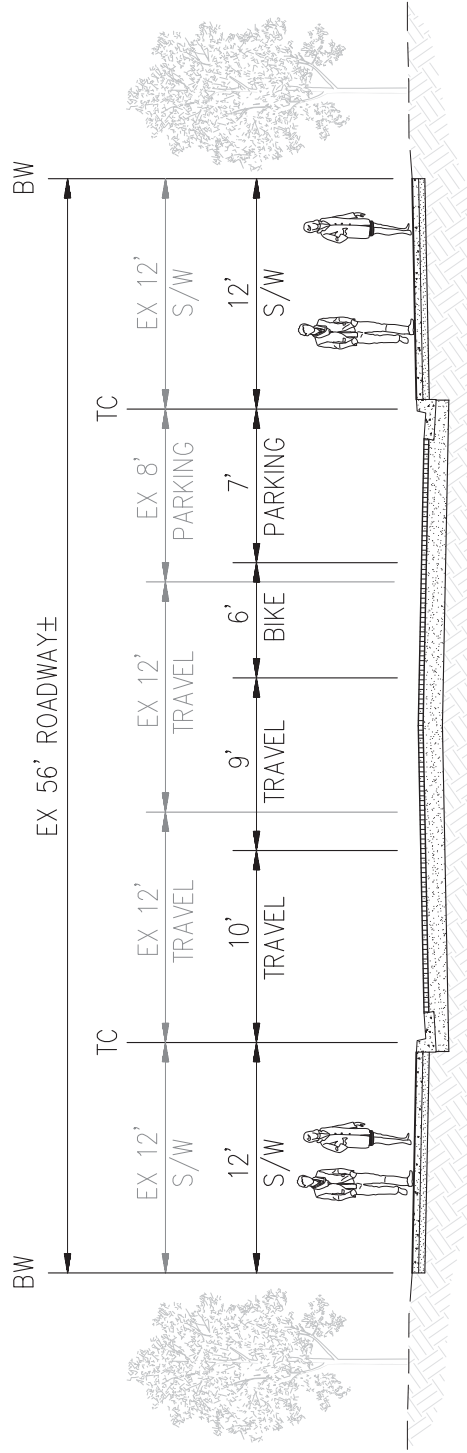

RETROFITTED CROSS-SECTION

ALAMEDA POINT
MASTER INFRASTRUCTURE PLAN
 CITY OF ALAMEDA ALAMEDA COUNTY CALIFORNIA
 DATE: JUNE, 2013 NOT TO SCALE
Carlson, Barbee, & Gibson, Inc.

FIGURE 24
SARATOGA STREET
REUSE AREAS



NOTE:

THIS STREET SECTION IS DRAFT AND PENDING INPUT FROM THE PLANNING BOARD SUBCOMMITTEE REVIEWING STREET SECTION REQUIREMENTS THROUGHOUT THE CITY.

STREET CLASSIFICATIONS

- LOCAL STREET
- CLASS II BIKE LANES

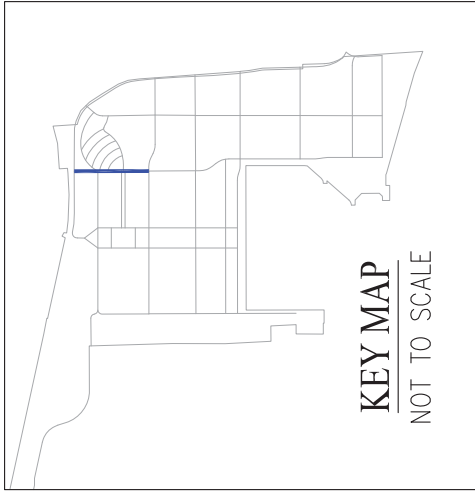

EXISTING CONDITIONS

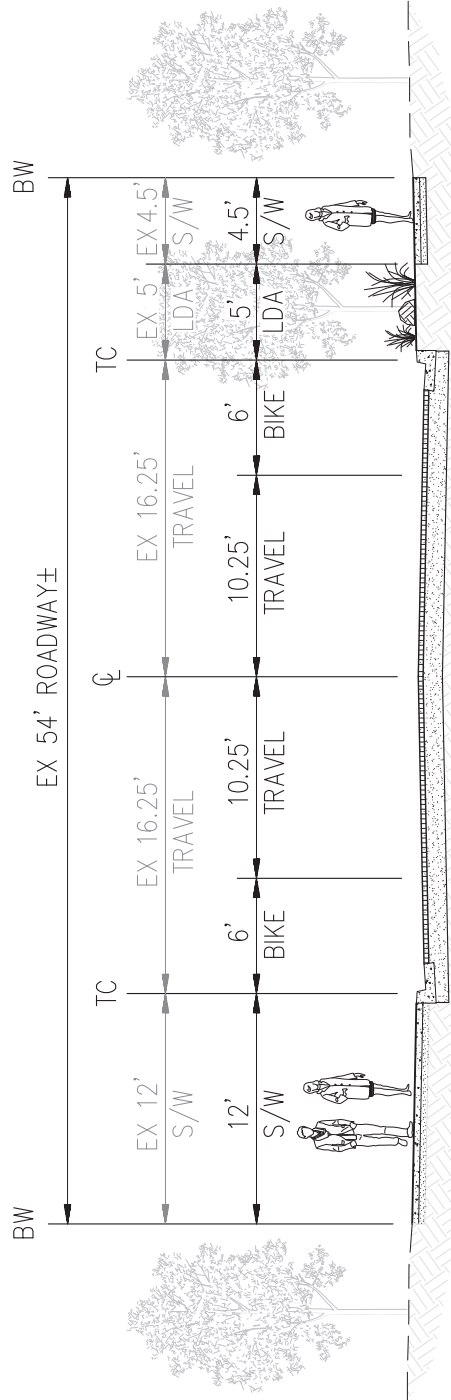

CONSTRUCTION NOTE:

REHAB EX PAN AM WAY FROM MIDWAY TO REDLINE.
NEW CONSTRUCTION FROM REDLINE TO MAIN STREET.

RETROFITTED CROSS-SECTION

ALAMEDA POINT MASTER INFRASTRUCTURE PLAN
CITY OF ALAMEDA ALAMEDA COUNTY CALIFORNIA
DATE: JUNE, 2013 NOT TO SCALE
Carlson, Barbee, & Gibson, Inc.

FIGURE 24 PAN AM WAY REUSE AREAS



NOTE:

THIS STREET SECTION IS DRAFT AND PENDING INPUT FROM THE PLANNING BOARD SUBCOMMITTEE REVIEWING STREET SECTION REQUIREMENTS THROUGHOUT THE CITY.

STREET CLASSIFICATIONS

- LOCAL STREET

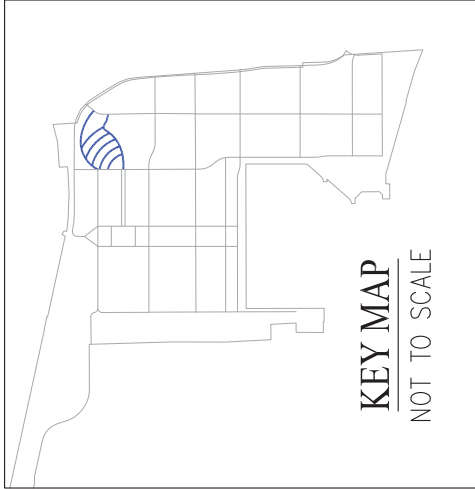

EXISTING CONDITIONS

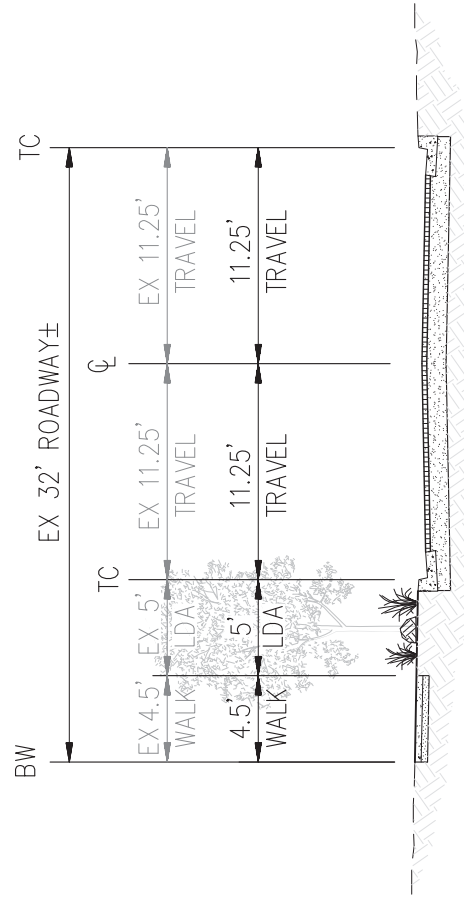

RETROFITTED CROSS-SECTION

**ALAMEDA POINT
MASTER INFRASTRUCTURE PLAN**
CITY OF ALAMEDA ALAMEDA COUNTY CALIFORNIA
DATE: JUNE, 2013 NOT TO SCALE
Carlson, Barbee, & Gibson, Inc.

**FIGURE 24
BIG WHITES
REUSE AREAS**

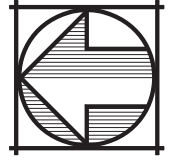

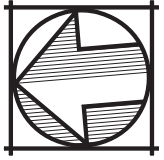
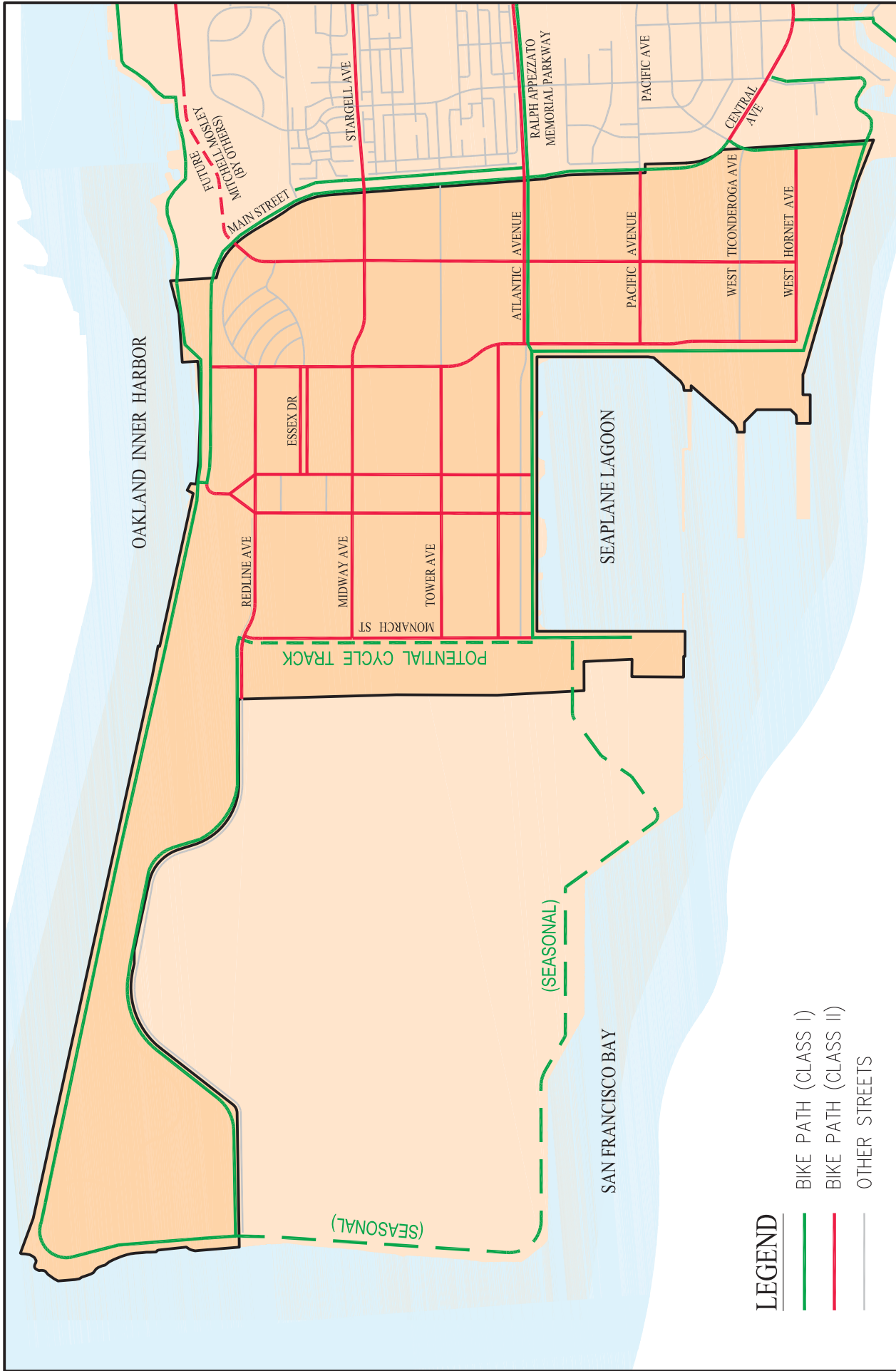
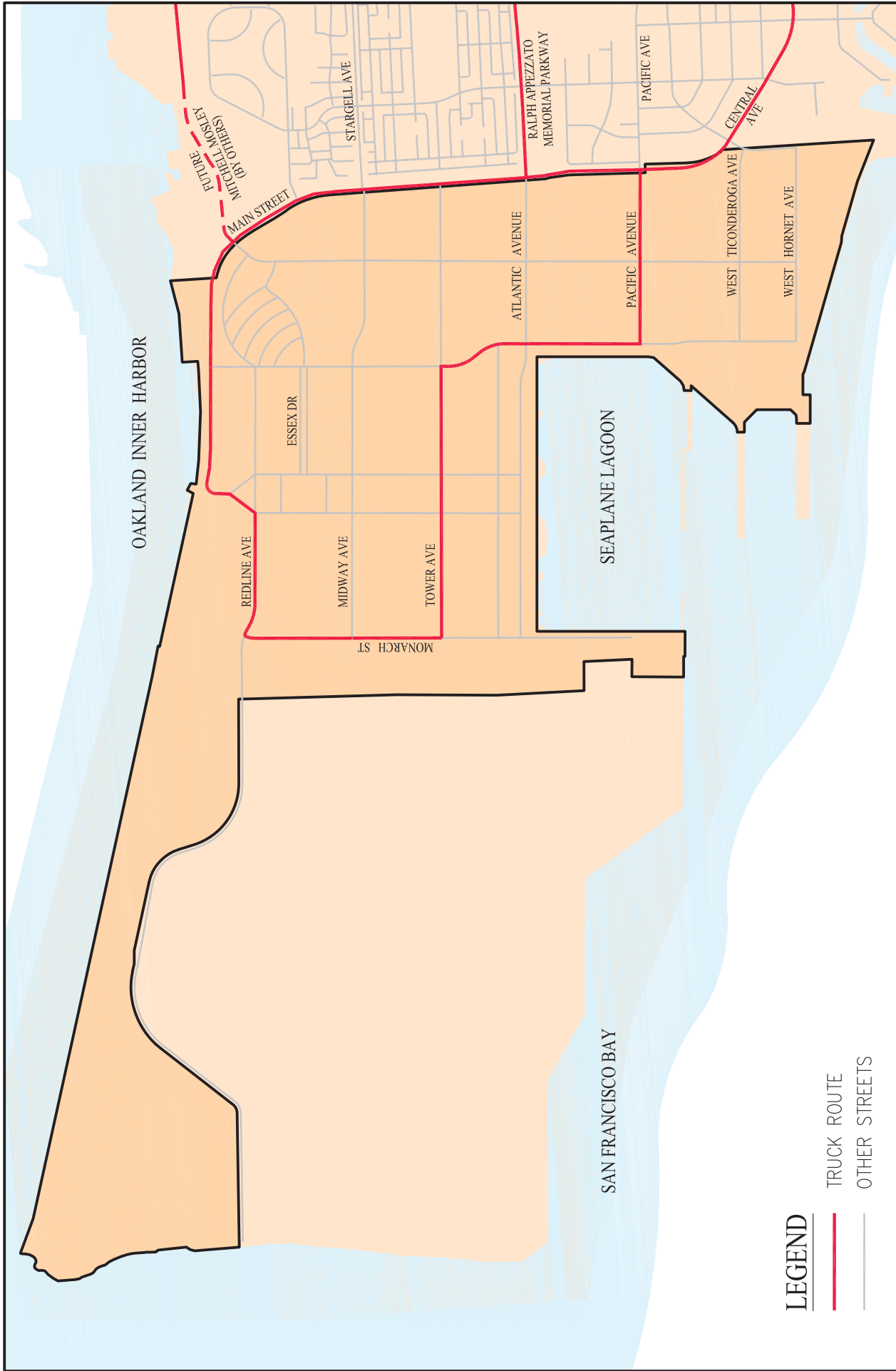

FIGURE 25 PROPOSED BIKE FACILITIES

**ALAMEDA POINT
MASTER INFRASTRUCTURE PLAN**
CITY OF ALAMEDA ALAMEDA COUNTY CALIFORNIA
DATE: JUNE, 2013 SCALE: 1" = 1,500'
Carlson, Barbee, & Gibson, Inc.

G:\1087-10\ACAD-10\EXHIBITS\BASE CASE ALT - FIGURES\B_25_PROPOSED BIKE FACILITIES.DWG



LEGEND

- TRUCK ROUTE
- OTHER STREETS

**ALAMEDA POINT
MASTER INFRASTRUCTURE PLAN**
 CITY OF ALAMEDA ALAMEDA COUNTY CALIFORNIA
 DATE: JUNE, 2013 SCALE: 1" = 1,500'
Carlson, Barbee, & Gibson, Inc.

**FIGURE 26
PROPOSED TRUCK ROUTE**

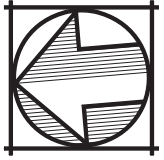

C. Proposed Transit System

1. Existing Transit Systems

There are two existing transit options at Alameda Point. There is existing bus service to portions of Alameda Point. Currently, AC Transit operates Line 31 which provides daily bus service through the central portions of Alameda Point. The destinations of this bus route include MacArthur and the Oakland Civic Center BART Stations. Additionally, the Alameda Ferry Terminal is located on the north side of Main Street adjacent to the northeastern portion of the Project Site. Water Emergency Transportation Authority (WETA) operates daily commuter and excursions ferry service from this terminal to San Francisco Ferry Building and Pier 41. Limited commuter service to South San Francisco is also provided.

2. Proposed Transit Systems

Alameda Point is a transit-oriented community designed to maximize the transit options for the community. Reliable and efficient transit service that connects to the regional transit system is critical for the redevelopment of Alameda Point. The transit options must be attractive to the residents and employees at Alameda Point. Transit will be effective if it is comparable or even faster than vehicles. A range of transit strategies, measures and services will be combined into a comprehensive program that will be continually monitored and maintained to remain effective and beneficial to the community.

The proposed transit system includes an on-site Multi-Modal Transit Center, Shuttle Service, street improvements to facilitate Bus Rapid Transit (for west end Alameda), enhanced Ferry Service, and a Transportation Demand Management Plan. See Figure 27 depicting the proposed locations of the components of the proposed transit system.

a. Multi-Modal Transit Center

The proposed Multi-Modal Transit Center will be located near West Atlantic Avenue, within the Waterfront Town Center Sub-District. The Transit Center could include parking areas, car-sharing services, bicycle-sharing services, and connections to the multi-modal components of the proposed street system. Other elements of the Transit Center may include taxi stand, casual carpool loading area, travel information, way-finding signage, and a transportation management center.

b. Shuttle Service

As part of the initial development phases at Alameda Point, a shuttle will be implemented between Alameda Point and the 12th Street BART Station in Downtown Oakland. This shuttle will provide a high frequency transit option for residents and employers at Alameda Point. This shuttle would originate at the Multi-Modal Transit Center, potentially stop at other locations within the Project Site as well, and then utilize the Ralph Appezato Memorial Parkway (RAMP) / Webster Street corridor to reach Downtown Oakland. The shuttle service is anticipated to evolve with each phase of development. Implementation and operation of the shuttle service will be flexible so that it can quickly adapt to development patterns guided by market forces.

c. Bus Rapid Transit

The City of Alameda is actively preparing and processing a Regional Transit Access Study. This study evaluates opportunities to enhance transit service to connect the City of Alameda, including Alameda Point, with regional BART transit facilities. The Study provides recommendations and

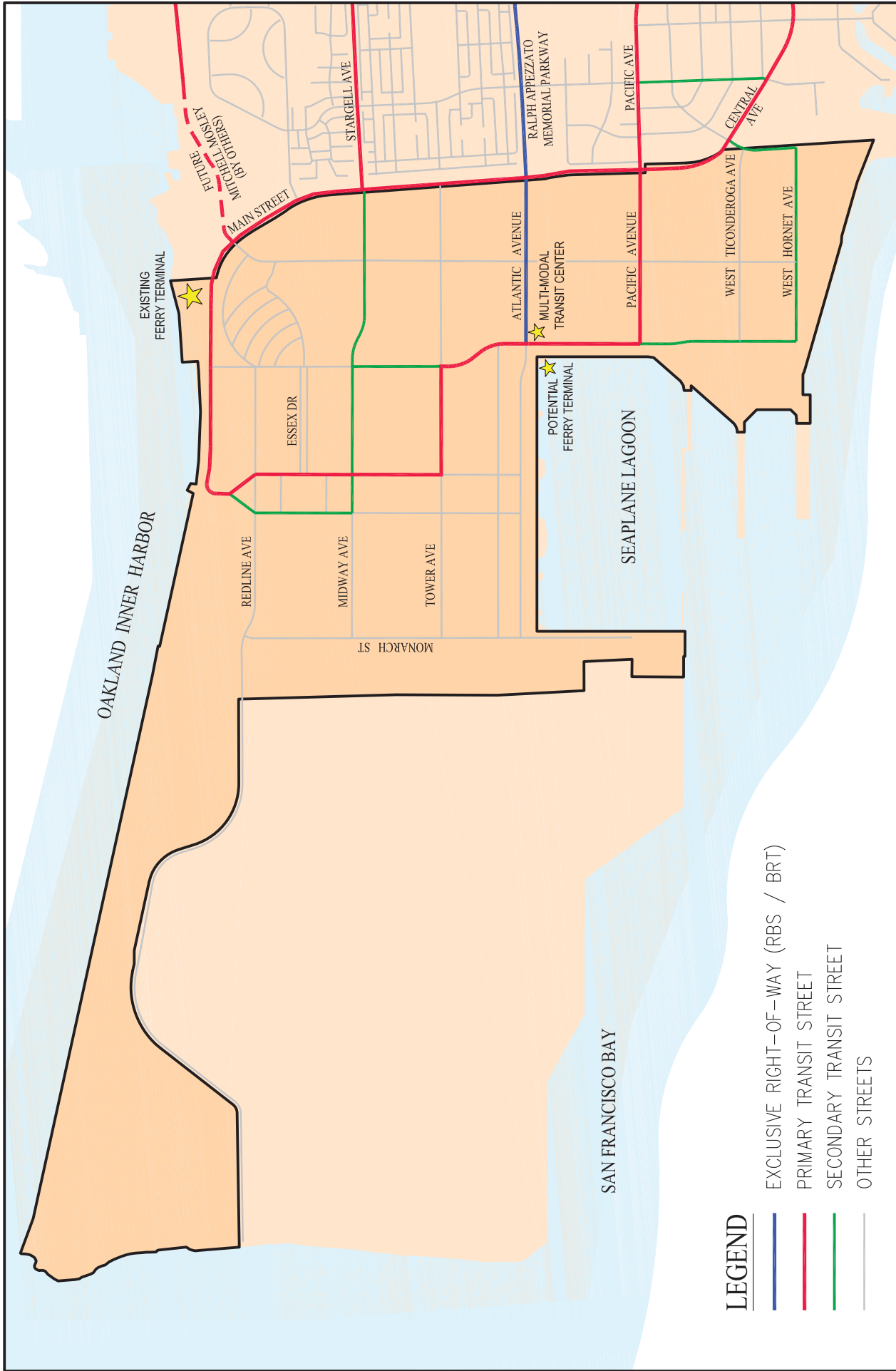

LEGEND

- EXCLUSIVE RIGHT-OF-WAY (RBS / BRT)
- PRIMARY TRANSIT STREET
- SECONDARY TRANSIT STREET
- OTHER STREETS

**ALAMEDA POINT
MASTER INFRASTRUCTURE PLAN**
CITY OF ALAMEDA ALAMEDA COUNTY CALIFORNIA
DATE: JUNE, 2013 SCALE: 1" = 1,500'
Carlson, Barbee, & Gibson, Inc.

**FIGURE 27
PROPOSED TRANSIT SYSTEMS**

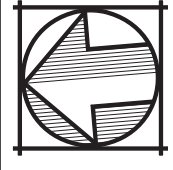

findings for the proposed Bus Rapid Transit (BRT) improvements for Alameda Point. The study also provides information for the proposed Rapid Bus service improvements for northern central Alameda. The draft proposed BRT improvements are summarized as follows:

The BRT will originate at the proposed Multi-Modal Transit Center. The BRT will connect Alameda Point to the 12th Street BART station and Downtown Oakland. For outbound (eastbound) traffic, the BRT will provide a dedicated bus-only lane from the Transit Center at West Atlantic Avenue to eastbound RAMP, and northbound Webster Street. The dedicated lane will end at Stargell Avenue and the BRT will then operate in mixed flow (transit and automobiles) from Stargell Avenue to Downtown Oakland/BART. The inbound traffic will operate in mixed flow from Downtown Oakland/BART to the Transit Center. The BRT will also incorporate measures to increase the bus operating speed. These measures will include traffic signal priority measures, bus queue jump lanes and enhanced boarding. The BRT will utilize the RAMP / Webster Street corridor. Improvements at the intersections of Webster Street / RAMP and Webster Street / Stargell Avenue will be required to improve the bus operating speed. Enhanced bus stops will also be provided at the Multi-Modal Transit Center, RAMP/Main Street, RAMP/Poggi Street and RAMP/Webster Street intersections. The proposed route of the BRT within Downtown Oakland will include shared travel lanes on the following streets:

- North of Harrison Street to 14th Street
- West of 14th Street to Clay street
- East on 12th Street
- South on Broadway
- East on 7th Street
- South on Webster Street (return to Alameda)

Transit signal enhancement will be incorporated at the following intersections within Downtown Oakland:

- Harrison Street and 14th Street
- 14th Street and Clay Street
- Clay Street and 12th Street
- Broadway and 7th Street

Similarly, up to four enhanced bus stops are contemplated within Downtown Oakland at the following locations:

- 14th Street and Broadway
- 12th Street and Broadway
- Northbound stop on Harrison Street
- Southbound stop on 7th Street or Webster Street

It is anticipated that these improvements will result in BRT approximate travel time of 12 minutes from Alameda Point to the 12th Street BART Station.

The Alameda Point Project will construct transit improvements within West Atlantic Avenue and RAMP corridor to facilitate the implementation of the BRT. The actual implementation of the BRT is subject to coordination between the City of Alameda and local public transit agencies and providers.

d. Ferry Service

Ferry service for Alameda Point will be provided either at the existing Alameda Ferry Terminal along the northern shoreline of Alameda Point, or at a new ferry terminal located in the Seaplane Lagoon near the Multi-Modal Transit Center. Either location will provide the Project Site with frequent, high-speed ferry service between Alameda and San Francisco.

e. Transportation Demand Management Plan

A Transportation Demand Management Plan (TDMP) with an annual monitoring and reporting requirement will be prepared for Alameda Point to continuously evaluate the effectiveness of the proposed transit system and other transportation demand management strategies. Based on the monitoring results, the TDMP will refine the transit strategies and demand management programs to minimize project impacts, reduce congestion, and meet vehicle miles travel reduction goals.

D. Proposed Off-Site Street Improvements

The transportation planning for Alameda Point will also include improvements to off-site streets and intersections located in the surrounding areas of Alameda to address project impacts outlined as mitigation measures in the EIR. These are in addition to the transit improvements discussed above and will either be constructed by Alameda Point or Alameda Point will make a fair-share contribution towards the construction by others. See Figure 28 depicting the locations of the off-site street improvements associated with Alameda Point. The proposed off-site street and intersection improvements may include the following items or others as specified by the EIR:

- Project Improvements - Vehicle Improvements
 - Farnside Boulevard / Otis Drive - Intersection and Signal Improvements
 - Main Street / Pacific Avenue - Signal Improvements
 - Webster Street / RAMP - Signal Improvements
 - Park Street / Otis Drive - Signal Improvements
 - Broadway / Tilden Way - Signal Improvements
 - High Street / Farnside Boulevard - Signal Improvements
 - Atlantic Avenue / Constitution Way - Signal Modification

- Project Improvements - Bicycle Improvements
 - Stargell Avenue Class I Trail - Main Street to 5th Street
 - Main Street Class I Trail - RAMP to Pacific Avenue
 - Central Avenue Class I and II Trail - Pacific Avenue to 4th Street



LEGEND

- OFF-SITE IMPROVEMENTS
- OFF-SITE IMPROVEMENT CONTRIBUTIONS
- FUTURE BRT ROUTE & BUS STOP
- OTHER MAJOR ROADWAYS
- BART EXISTING BART STATION

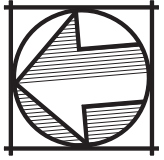

**FIGURE 28
OFF-SITE STREETS & TRANSIT**

**ALAMEDA POINT
MASTER INFRASTRUCTURE PLAN**
 CITY OF ALAMEDA ALAMEDA COUNTY CALIFORNIA
 DATE: JUNE, 2013 SCALE: 1" = 3,500'
Carlson, Barbee, & Gibson, Inc.

G:\1087-10ACAD-10\EXHIBITS\BASE CASE ALT - FIGURES\B_28_OFFSITE STREETS & TRANSIT.DWG

- Project Contributions (Pro-Rata Share) - Vehicle Improvements
 - Park Street / Clement Avenue - Intersection Improvements
 - Park Street / Encinal Avenue - Intersection Improvements
 - Broadway / Otis Drive - Intersection Improvements
 - Tilden Way / Blanding Avenue / Fernside Boulevard - Intersection Improvements
 - High Street / Fernside Boulevard - Intersection Improvement
 - High Street / Otis Drive - Intersection Improvements
 - Island Drive / Otis Drive / Doolittle Drive - Intersection Improvements
 - Fernside Boulevard / Otis Drive - Signal Modification
 - Park Street / Blanding Avenue - Intersection Improvements
 - Challenger Drive / Atlantic Avenue - Signal Improvements
 - Park Street / Lincoln Avenue - Signal Improvements

- Project Contributions (Pro-Rata Share) - Pedestrian Improvements
 - Main Street / Pacific Avenue - Signal Improvements
 - Webster Street / RAMP - Signal Improvements
 - High Street / Fernside Boulevard - Intersection Improvements
 - Atlantic Avenue / Constitution Way - Signal Modification

- Project Contributions (Pro-Rata Share) - Transit Improvements
 - Park Street Transit Signal Priority - Blanding Avenue to Otis Drive
 - RAMP Transit Corridor Improvements - Main Street to Webster Street (including transit Signal priority, exclusive transit lane eastbound)
 - Stargell Avenue Queue Jump Lanes - Main Street and 5th Street Intersection

- Project Contributions (Pro-Rata Share) - Bicycle Improvements
 - Stargell Avenue Class I Trail - Main Street to 5th Street
 - Main Street Class I Trail - RAMP to Pacific Avenue
 - Central Avenue Class I and II Trail - Pacific Avenue to 4th Street
 - Oak Street Bicycle Boulevard - Santa Clara Avenue to Central Avenue

V. PARKS AND OPEN SPACE

A. Existing Parks and Community Facilities

There is a number of existing park and community facilities within Alameda Point that are currently actively used. These facilities provide a range of benefits and uses to the community. The existing facilities within Alameda Point are as follows:

1. Existing Parks & Open Space Areas

- Alameda Point Multi-Purpose Field (W. Redline Avenue)
- City View Skate Park
- Main Street Dog Park
- Main Street Linear Park
- Main Street Soccer Field
- Hornet Soccer Field
- Lexington Street Soccer Fields
- Encinal Boat Ramp
- Parade Grounds
- Entry Monuments

2. Existing Community Facilities

- Alameda Point Gymnasium
- Albert DeWitt Officer's (O) Club

See Figure 29 depicting the locations of the various existing parks and community facilities within Alameda Point.

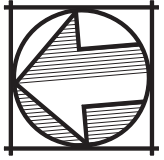
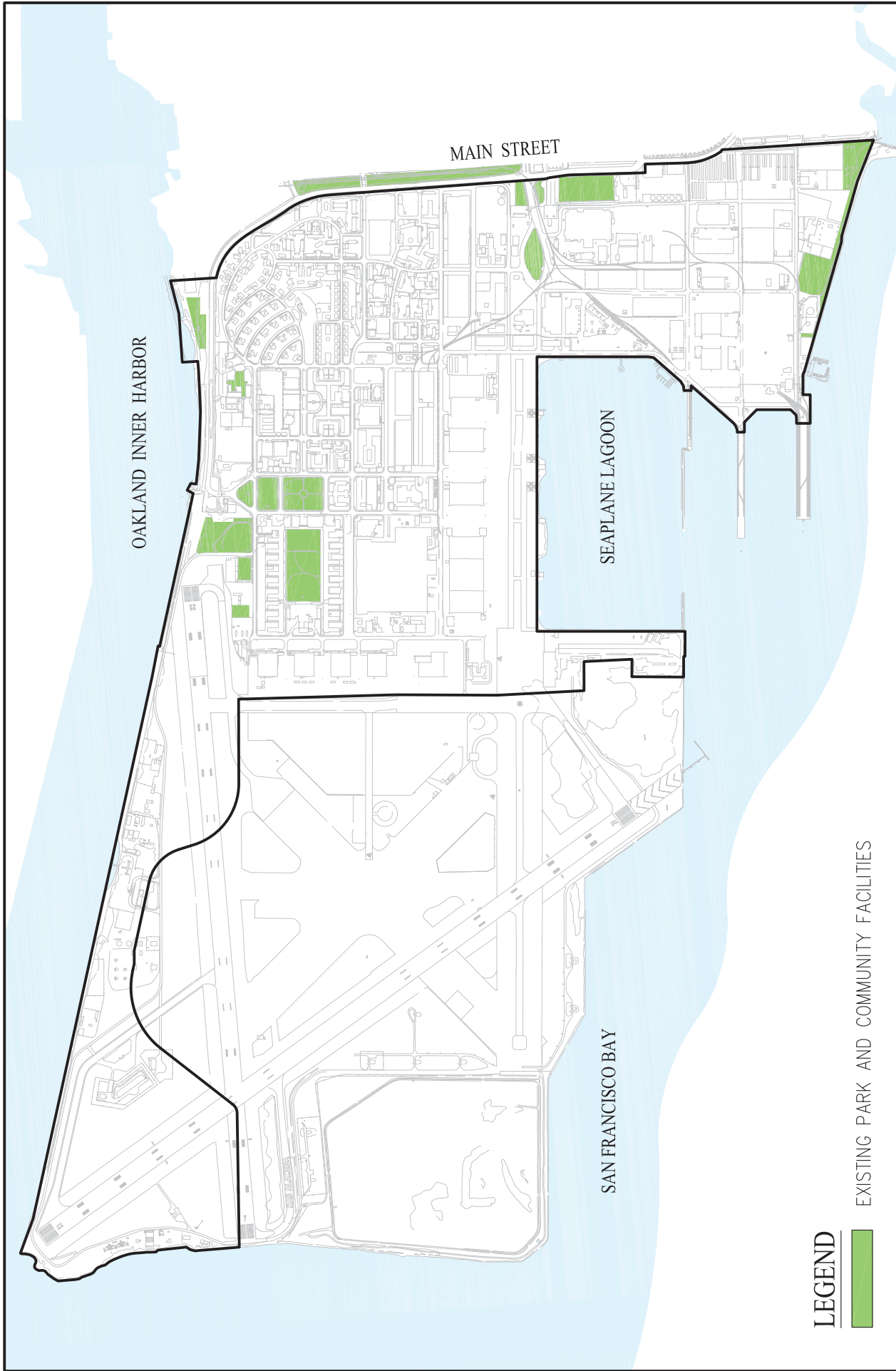

FIGURE 29
EXISTING PARK AND
COMMUNITY FACILITIES

ALAMEDA POINT
MASTER INFRASTRUCTURE PLAN
 CITY OF ALAMEDA ALAMEDA COUNTY CALIFORNIA
 DATE: JUNE, 2013 SCALE: 1" = 1,500'
Carlson, Barbee, & Gibson, Inc.

G:\1087-10\ACAD-10\EXHIBITS\BASE CASE ALT - FIGURES\B_29_EX_PARK FACILITIES.DWG

B. City of Alameda's Urban Greening Plan and Parks Improvement Assessment

The City of Alameda prepared an Urban Greening Plan and Parks Improvement Assessment in 2012. This Plan defines a strategy of refinements and enhancements to the existing and proposed park system within the City of Alameda in order to meet the evolving needs of the community. This plan integrates the existing and new park improvements with a Urban Greening Plan targeted to mitigate the long-term effects of climate change and achieving a more sustainable and healthy community. Through this process the plan has established goals, standards and recommendations for the open space and park facilities at Alameda Point. These are summarized as follows:

- Assign high priority to maintenance and renovation of existing parks and facilities, where feasible.
- Develop new neighborhood and community parks to achieve 3 acres of park area for each 1,000 residents.
- Develop a Regional Sports Complex that includes a variety of sports fields and uses that are a benefit to the entire community of Alameda and larger region.
- Promote public water-oriented uses within the Public Trust Areas depicted on Figure 30. These uses may include navigation, fisheries, maritime, hotels, water-oriented recreation, restaurants, visitor serving retail, parks and open space.
- Establish partnerships with public and private partners for the management of large passive parks.
- Expand access to Alameda's shoreline.
- Improve and expand the City's trail system to provide recreational opportunities and improve access to parks and shoreline.
- Upgrade parks and facilities to ADA standards to ensure accessibility for all.

C. Proposed Open Space Framework

The proposed open space framework at Alameda Point is comprised of three major components: the Nature Reserve, Primary Open Spaces and Secondary Open Spaces. The redevelopment of Alameda Point will incorporate numerous parks, open space, trail and community facilities. See Figure 31 depicting an illustrative depiction of the proposed open space system. Additional, "in-tract" or "on-site" parks are not depicted on this figure but will be constructed as part of the proposed system. The proposed facilities are outlined as follows:

1. Nature Reserve

The Nature Reserve is located in the western portions of Alameda Point and is owned by the Federal Government. The Nature Reserve provides long-term protection of habitat primarily for the endangered California Least Tern and other wildlife. Public access within the Nature Reserve will be limited to a seasonal trail along the perimeter of the reserve consistent with federal requirements.

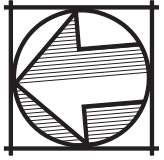
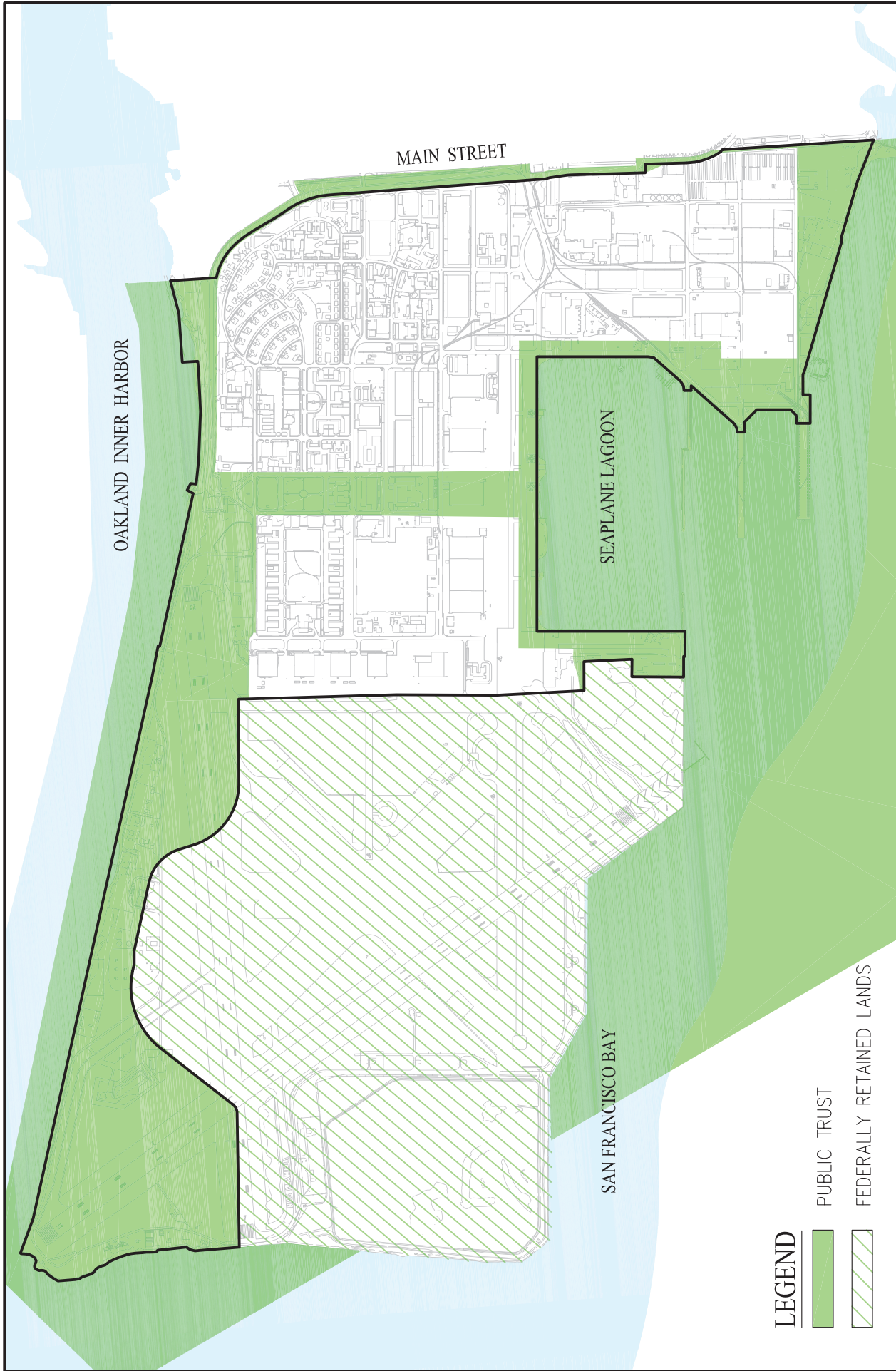

**FIGURE 30
PUBLIC TRUST**

**ALAMEDA POINT
MASTER INFRASTRUCTURE PLAN**
 CITY OF ALAMEDA ALAMEDA COUNTY CALIFORNIA
 DATE: JUNE, 2013 SCALE: 1" = 1,500'
Carlson, Barbee, & Gibson, Inc.

G:\1087-10\ACAD-10\EXHIBITS\BASE CASE ALT - FIGURES\B_30_PUBLIC TRUST.DWG

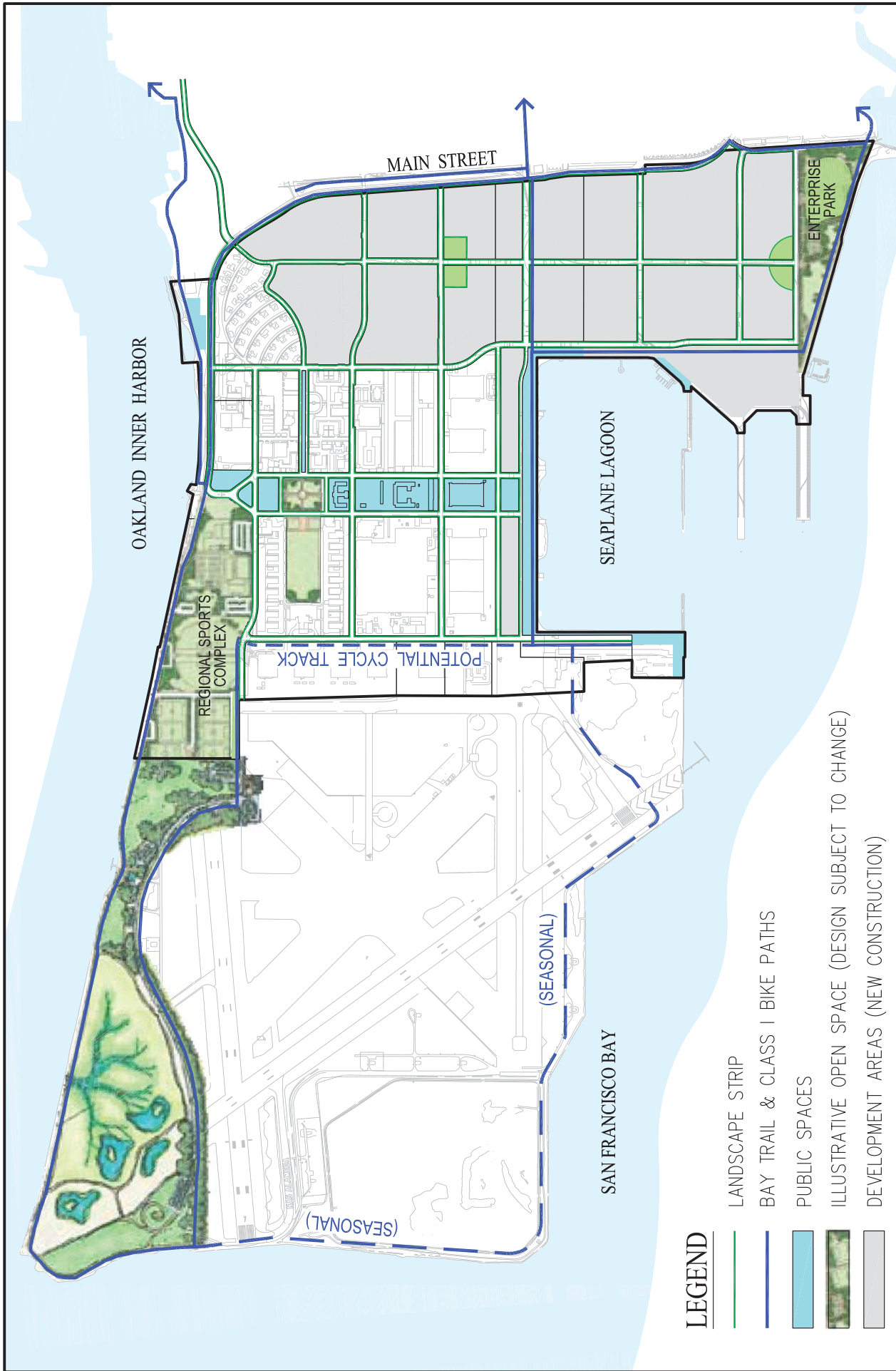

FIGURE 31 ILLUSTRATIVE OPEN SPACE

**ALAMEDA POINT
MASTER INFRASTRUCTURE PLAN**
 CITY OF ALAMEDA ALAMEDA COUNTY CALIFORNIA
 DATE: JUNE, 2013 SCALE: 1" = 1,500'
Carlson, Barbee, & Gibson, Inc.

G:\1087-10ACAD-10\EXHIBITS\BASE CASE ALT - FIGURES\WB_31_PROPOSED OPEN SPACE.DWG

2. Primary Open Spaces

The Primary Open Spaces provide full public access and focus on visitor and community serving uses that support active recreational, community and social functions. The Primary Open Spaces include:

- Alameda Point Regional Sports Complex – Integrate the existing Alameda Point Multi-Purpose Field, Alameda Point Gymnasium, and City View Skate Park with additional sports fields and uses desired by the Alameda community, where feasible.
- Main Street Dog Park – Preserve this existing facility, if possible.
- Main Street Linear Park and Flood Control Channel – Preserve this existing facility.
- Enterprise Park – Integrate and upgrade the existing campground and Encinal Boat Ramp with additional open space consistent with the Public Trust.
- Lexington Street Soccer Fields – Preserve this existing facility.
- Parade Grounds – Preserve this existing historic facility.
- Neighborhood Parks – Construct new neighborhood parks to serve the residents which include a variety of elements, such as children’s play areas, picnic tables, gathering areas, community gardens, etc., especially within the Main Street Neighborhood Sub-District.
- Seaplane Lagoon Frontage – Improve a shoreline park that frames the edges of the Seaplane Lagoon. Portions of this features will be highly amenitized, including water oriented elements such as pedestrian walks, bicycle paths, vista points, seat/rest areas, etc.
- Northwest Territories – Improve this large area with passive uses such as, wetland restoration, picnic areas, trails, trailhead, etc.

3. Secondary Open Spaces

The Secondary Open Spaces are park areas of a smaller scale that provide environmental, agricultural and social gathering areas supporting passive recreational, social and transportation uses and provide linkages throughout the new neighborhoods. The Secondary Open Spaces include:

- Bay Trail – Construct the Bay Trail along the perimeter of the Project Site, Seaplane Lagoon, and VA Property.
- Main Street – Construct a Class I trail along the west side of Main Street to provide a linkage between the northern and southern shorelines.

4. Community Facilities

- Alameda Point Gymnasium – Preserve this existing facility and implement ADA and seismic retrofits.
- Albert DeWitt Officer’s Club – Preserve this existing facility and implement ADA and seismic retrofits.

VI. WASTEWATER

A. Existing Wastewater System

1. Existing On-Site Wastewater Collection System

The existing wastewater collection system within Alameda Point is owned and maintained by the City of Alameda. The existing collection system consists of gravity pipelines ranging in size from 4-inch to 30-inch in diameter, 15 pump / lift stations, and force mains ranging from 4-inch to 8-inch in diameter. There is approximately 28 miles of existing wastewater pipelines within the Project Site comprised of the following:

- Gravity Mainlines = 14.2 Miles
- Force Mains = 2.3 Miles
- Building Laterals = 8.7 Miles
- Previously Abandoned Lines = 2.8 Miles

This system collects and conveys wastewater from the Project Site to the existing Pump Station, referred to as Pump Station 1, located just west of the Main Gate at the northern edge of Alameda Point.

The Navy began the installation of this system approximately 70 years ago. The system is currently functional, however, the system is beyond its service life and has numerous deficiencies. Most notably, the majority of the system has deteriorated due to the age of the system and differential settlement has occurred over time at the Project Site. These effects of time have resulted in groundwater infiltration entering the on-site collection system and downstream transmission system. Additionally, portions of the existing system have adverse slopes causing wastewater build-up and stagnant conditions. There are portions of the collection pipelines that are located under existing buildings and outside of the existing and proposed backbone street rights of ways. The existing wastewater collection system does not meet the City's standards. See Figure 32 depicting the configuration of the existing wastewater collection system at Alameda Point.

Recent flow monitoring conducted by EMBUD just upstream of Pump Station 1 indicates the existing peak wet weather wastewater flow from Alameda Point is approximately 1.93 MGD.

2. Existing Off-Site Wastewater Transmission Facilities

The existing on-site wastewater collection system terminates at Pump Station 1. Historically, the wastewater flows from Alameda Point were pumped from Pump Station 1 under the Oakland - Alameda Estuary and through the Port of Oakland site, eventually connecting to an EBMUD trunk main, "Interceptor", that conveyed the flows to the EBMUD Main Wastewater Treatment Plant (MWWTP). The location of the historical Estuary crossing was approximately 3,000-feet west of Pump Station 1. In the early 2000's, the Port of Oakland dredged the Estuary to a depth that conflicted with the existing pipeline crossing. Accordingly, the City of Alameda, EBMUD and the Port of Oakland coordinated a project to reroute the wastewater from Alameda Point to the east and to cross the Estuary at the existing EBMUD siphon facility near the Webster / Posey Tubes. This project was completed in 2003 and included the installation of approximately 8,600 linear feet of a 20-inch force main from the Pump Station 1 to the siphon facility. This force main flows from west to east along the northern shoreline of western Alameda. Additionally, a third 48-inch diameter siphon was added to the two existing 30-inch and 48-inch diameter siphons. These siphons convey wastewater flows from the entire main island of the City of Alameda under the Oakland

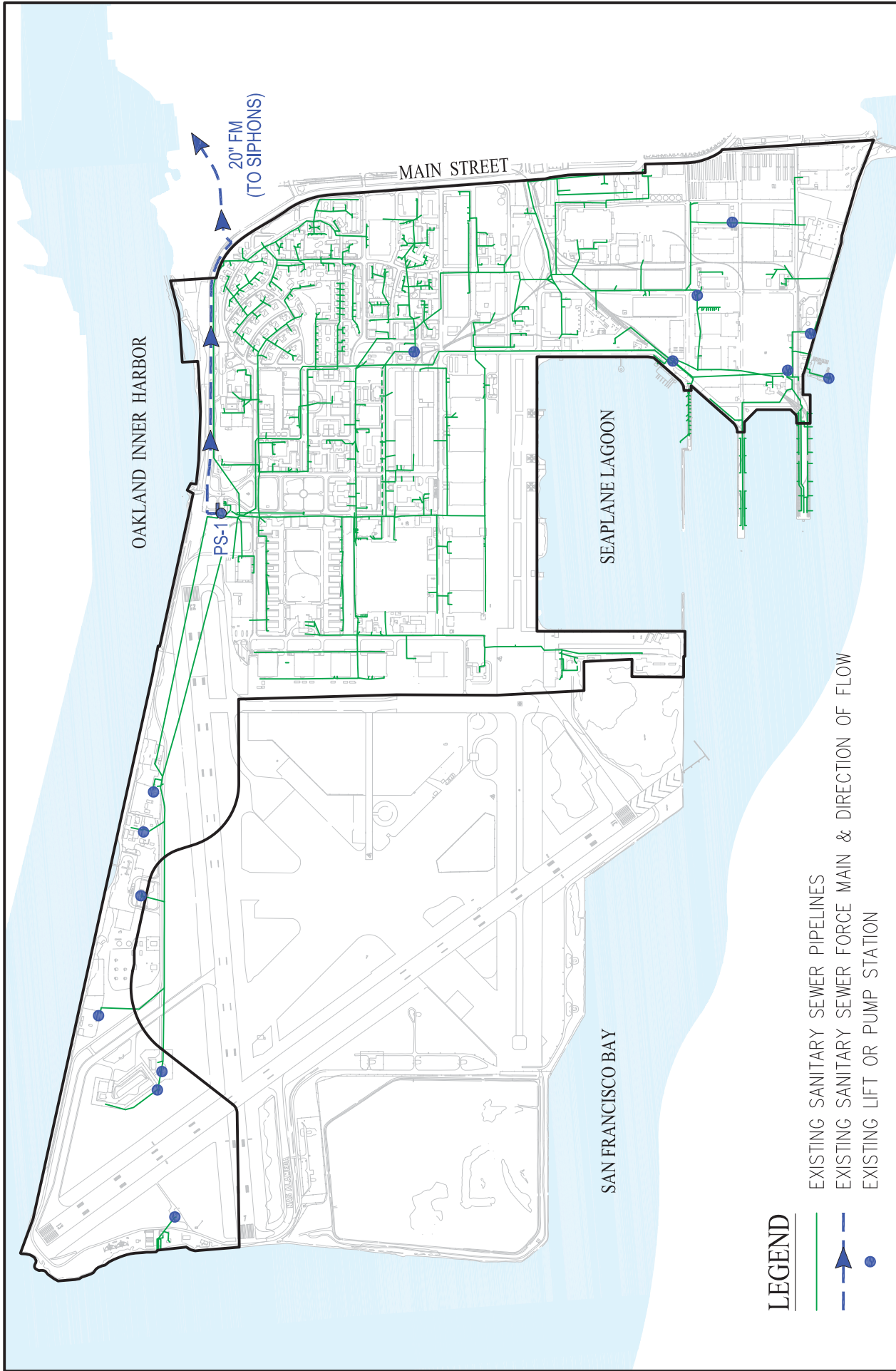

LEGEND

-  EXISTING SANITARY SEWER PIPELINES
-  EXISTING SANITARY SEWER FORCE MAIN & DIRECTION OF FLOW
-  EXISTING LIFT OR PUMP STATION

**ALAMEDA POINT
MASTER INFRASTRUCTURE PLAN**
 CITY OF ALAMEDA ALAMEDA COUNTY CALIFORNIA
 DATE: JUNE, 2013 SCALE: 1" = 1,500'
Carlson, Barbee, & Gibson, Inc.

**FIGURE 32
EXISTING SANITARY SEWER (ON-SITE)**

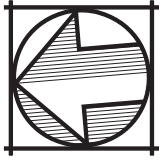

/ Alameda Estuary. The siphons then connect into EBMUD's Interceptor, which convey wastewater from the City of Alameda and portions of the City of Oakland to EBMUD's MWWTP. EBMUD's MWWTP is located near the eastern landing of the Bay Bridge in West Oakland, approximately 2.5 miles from the Project Site. See Figure 33 depicting the existing off-site wastewater transmission and treatment facilities.

Pump Station 1, the 20-inch force main, the siphon facility (Alameda Siphon) and the EBMUD Interceptor are owned and maintained by EBMUD. These facilities convey the wastewater generated at Alameda Point to the EBMUD MWWTP. EBMUD's design reports indicate that the existing capacity of Pump Station 1 is 7.5 MGD. The capacity of this pump station can be increased by increasing the size of the pumps and other equipment within the pump station. The existing 20-inch diameter force main has an existing capacity of 12.1 MGD. The third siphon that was constructed with the previously described project that rerouted the wastewater from Alameda Point is part of the Alameda Siphon. The existing peak wastewater flow within the Alameda Siphon is approximately 28 MGD.

3. Existing Wastewater Treatment

The EBMUD Main Wastewater Treatment Plant (MWWTP) currently has excess dry weather flow capacity. The current average dry weather flow to the MWWTP is approximately 54 MGD and the permitted dry weather flow of the MWWTP is 120 MGD.

In regards to wet weather flow capacity of EBMUD's treatment facilities, in January 2009, EBMUD entered into a Stipulated Order for Preliminary Relief from the U.S. Environmental Protection Agency, State of California Water Resources Control Board and the San Francisco Bay Regional Water Quality Control Board. This Stipulated Order outlines the measures EBMUD is required to implement in order to address inadequately treated sewage discharges to San Francisco Bay during wet weather conditions.

EBMUD's operates three wet weather facilities that handle excess sewage during storm events when flows exceed the capacity of the District's Main Wastewater Treatment Plant. The excess flows are largely caused by storm water and groundwater leaking into the region's aging sanitary sewer collection pipelines and through improper connections that allow storm water to flow into the sewer system. The intent of the Stipulated Order is to formulate long-term solutions to minimize the high level of infiltration to the East Bay collection systems and eliminate the discharge of the excess flows from the EBMUD's wet weather facilities.

The Stipulated Order requires EBMUD to conduct a flow monitoring study to identify the regions within the District's service area that generate the largest wet weather flows. This flow monitoring study is also intended to establish a range of scenarios of capacity flow limits for specific locations within the District's system that could eliminate the need for discharges from the wet weather facilities. A draft of this flow monitoring study has been prepared. EBMUD is currently working with the EPA and various stakeholders to develop a long-term plan for region-wide reductions.

Large redevelopment sites such as Alameda Point are expected to reduce the amount of infiltration and inflow entering the wastewater collection system through the replacement/rehabilitation of the aging, deteriorated sewer infrastructure with new systems that are constructed to current standards. EBMUD has indicated that the conclusions of their efforts to address the Stipulated Order will not limit the future growth



**ALAMEDA POINT
MASTER INFRASTRUCTURE PLAN**

CITY OF ALAMEDA ALAMEDA COUNTY CALIFORNIA

DATE: JUNE, 2013 SCALE: 1" = 3,000'

Carlson, Barbee, & Gibson, Inc.

**FIGURE 33
EXISTING SANITARY SEWER
(OFF-SITE TRANSMISSION)**

or redevelopment at Alameda Point. EBMUD recommends that the project incorporate the following measures to comply with the Stipulated Order and maintain capacity for the Project Site:

- Replace or rehabilitate any existing sanitary sewer collection system, including sewer lateral lines, to reduce infiltration/inflow, and
- Ensure any new wastewater collection systems for the project, including sewer laterals, are constructed to prevent infiltration/inflow to the maximum extent feasible.

B. Proposed Wastewater System

1. Proposed Wastewater Demand

The total estimate peak wastewater generated by the full build-out of the redevelopment of Alameda Point is approximately 2.16 MGD. The wastewater flow generation factors for the various proposed land uses are based on the current City of Alameda design criteria utilized in the City-Wide sewer model and outlined in Table 5. These wastewater generation factors do not account for the implementation of water conserving fixtures throughout the proposed buildings. The wastewater flow from the Project Site will be decreased with the implementation of sustainable strategies that achieve reductions in water consumption.

Table 5 - Wastewater Flow Generation Factors

Land Use	Flow Factor (Peak Dry Weather)
Residential	480 GPD / Unit
Commercial - Office/ Retail	0.20 GPD / SF
Commercial - Manufacturing / Warehouse	0.04 GPD / SF
Commercial - Service	1.00 GPD / SF
Park	3,000 GPD / Each
Park with Sports Complex	45,000 GPD / Each

Note: All areas additionally include a GWI and $1/3$ flow of 1,300 GPD / Net Acres (excluding Parks)

EBMUD has adequate dry weather capacity at the MWWTP for the projected wastewater flows from the redevelopment of Alameda Point. The project buildout would increase the peak wet weather flow by approximately 0.23 MGD above the existing peak flows. This takes into consideration that replacement of existing infrastructure is expected to reduce peak infiltration / inflow and partially offset the projected increase in base wastewater flow. Based on the current peak wastewater flow from the City of Alameda of 28 MGD, the estimated maximum additional flow from Alameda Point represents an increase of less than 1 percent in current peak wastewater flow conveyed through the Alameda Siphon. It represents an even smaller percentage of the current peak wastewater flow of 107 MGD in EBMUD's south interceptor just downstream of the Alameda Siphon.

2. Proposed On-Site Wastewater Collection System

a. Development Areas

A new wastewater collection system will be installed within the Development Areas, where large-scale areas of new construction are anticipated. The proposed collection system will include gravity pipelines, ranging in size from 8-inch to 24-inch in diameter, and 5 lift stations. The proposed system will connect to the existing Pump Station 1 located at the Main Gate. The existing wastewater system, pipelines and pump / lift stations, within the Development Areas will be replaced in phases consistent with the development build-out. The proposed wastewater collection facilities will be installed within all backbone streets within the Development Areas. See Figure 34 depicting the proposed on-site wastewater collection system schematic within the Development Areas.

The proposed on-site wastewater collection system will be owned and operated by the City of Alameda. The system shall be designed and constructed consistent with the City of Alameda's Standard Specifications and Design Criteria. All lift stations will include redundant pumps, alarm systems and emergency backup power supplies to ensure no disruption of service. The proposed wastewater collection system shall efficiently collect and convey the wastewater such that the amount of lift stations required is minimized. The gravity pipelines will be designed to accommodate settlement at locations where long term differential settlement is anticipated.

b. Reuse Areas



The existing wastewater collection system within the Reuse Areas will be incrementally replaced over time. Initially, the Reuse Areas will continue to utilize the existing wastewater collection system through an enhanced maintenance program. This program will rehabilitate the existing system to address deficiencies. Each proposed development within the Reuse Areas will be responsible for investigating and documenting the condition of the existing collection facilities that collect and convey the wastewater from that specific site. Any deficiencies identified shall be addressed at the time of that development to the satisfaction of the Public Works Director. The anticipated enhanced maintenance improvements include cleaning and lining of existing pipelines and manholes to address infiltration and inflow. Also, it is anticipated that portions of the existing pipelines will be required to be replaced to address adverse flow conditions and areas that have settled resulting in stagnant wastewater conditions.

Additionally, each development project within the Reuse Areas will replace the wastewater lateral and on-site pipelines serving that site, consistent with the City of Alameda's Private Sewer Lateral Replacement Ordinance. See Figure 35 depicting the existing on-site wastewater collection system schematic within the Reuse Areas to initially to be rehabilitated.

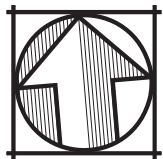
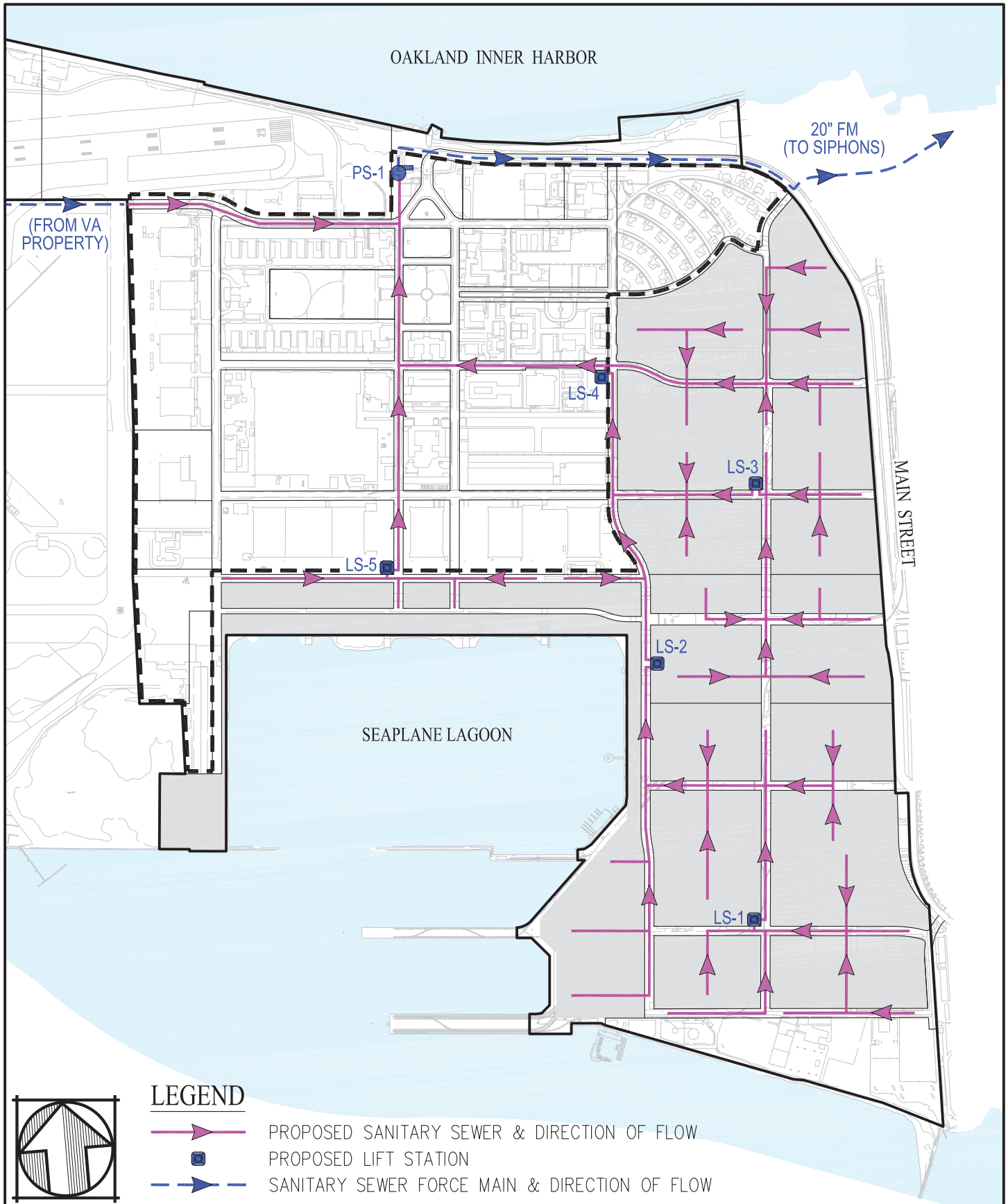
Ultimately, the wastewater collection system within the Reuse Areas will be replaced. The new system will be installed incrementally over time. As funds become available through a fee program, new backbone wastewater facilities will be installed. The City of Alameda will coordinate these improvements to ensure they are implemented orderly and with appropriate priorities. The proposed backbone collection system will be similar to the system proposed within the Development Areas, including new gravity pipelines and lift stations. The new collection pipes will connect to the adjacent on-site laterals and pipes. The system shall be designed and constructed consistent with the City of Alameda's Standard Specifications and Design Criteria. See Figure 36 depicting the ultimate on-site wastewater collection system schematic within the Reuse Areas.



LEGEND

-  PROPOSED SANITARY SEWER & DIRECTION OF FLOW
-  PROPOSED LIFT STATION
-  SANITARY SEWER FORCE MAIN & DIRECTION OF FLOW



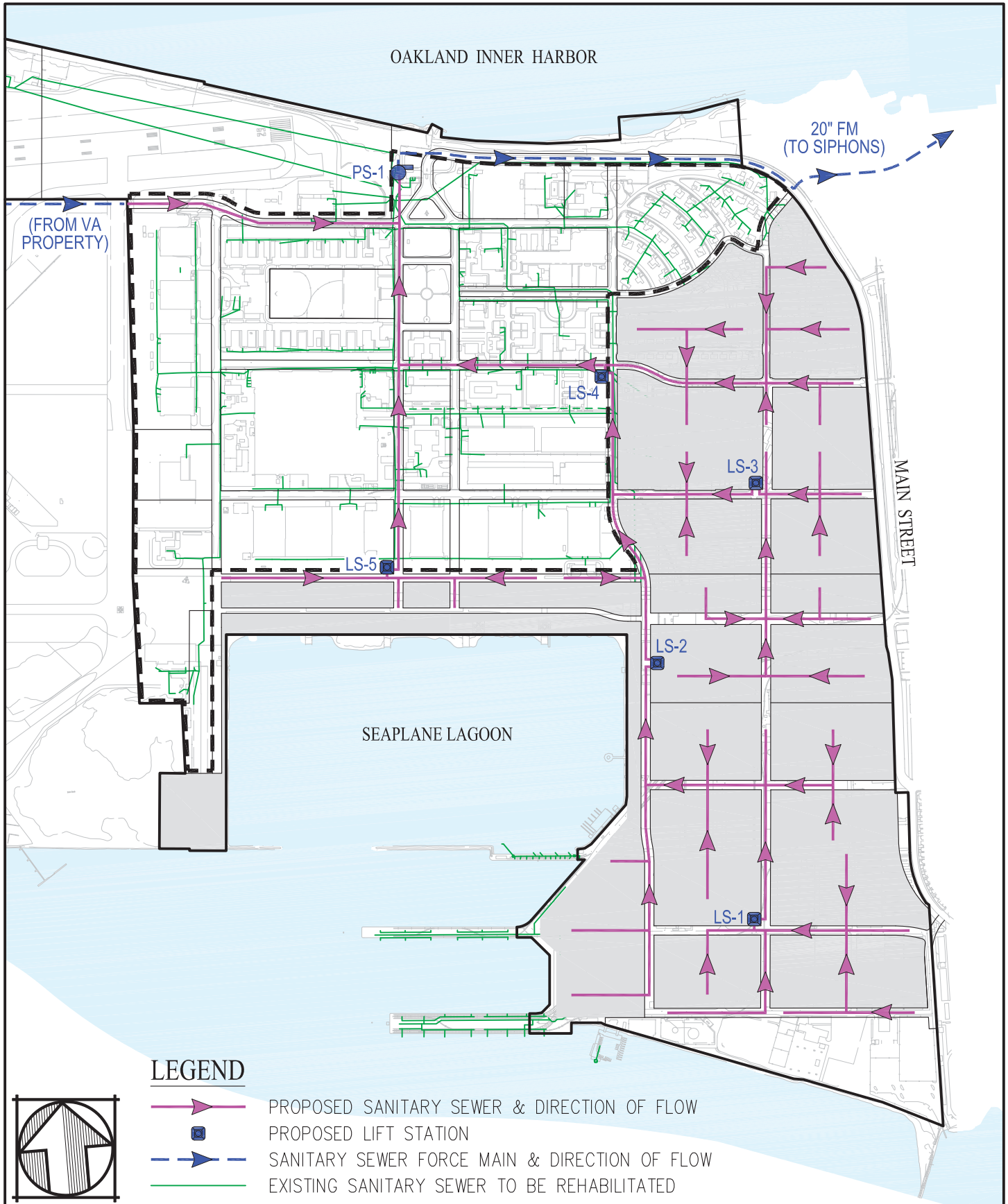

**ALAMEDA POINT
MASTER INFRASTRUCTURE PLAN**
 CITY OF ALAMEDA ALAMEDA COUNTY CALIFORNIA
 DATE: JUNE, 2013 SCALE: 1" = 1,000'
 Carlson, Barbee, & Gibson, Inc.

**FIGURE 34
PROPOSED SANITARY SEWER
IN DEVELOPMENT AREAS**

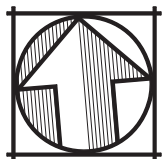

LEGEND



-  PROPOSED SANITARY SEWER & DIRECTION OF FLOW
-  PROPOSED LIFT STATION
-  SANITARY SEWER FORCE MAIN & DIRECTION OF FLOW
-  EXISTING SANITARY SEWER TO BE REHABILITATED

**ALAMEDA POINT
MASTER INFRASTRUCTURE PLAN**

CITY OF ALAMEDA ALAMEDA COUNTY CALIFORNIA



DATE: JUNE, 2013 SCALE: 1" = 1,000'

Carlson, Barbee, & Gibson, Inc.

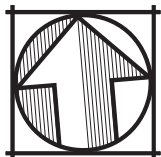
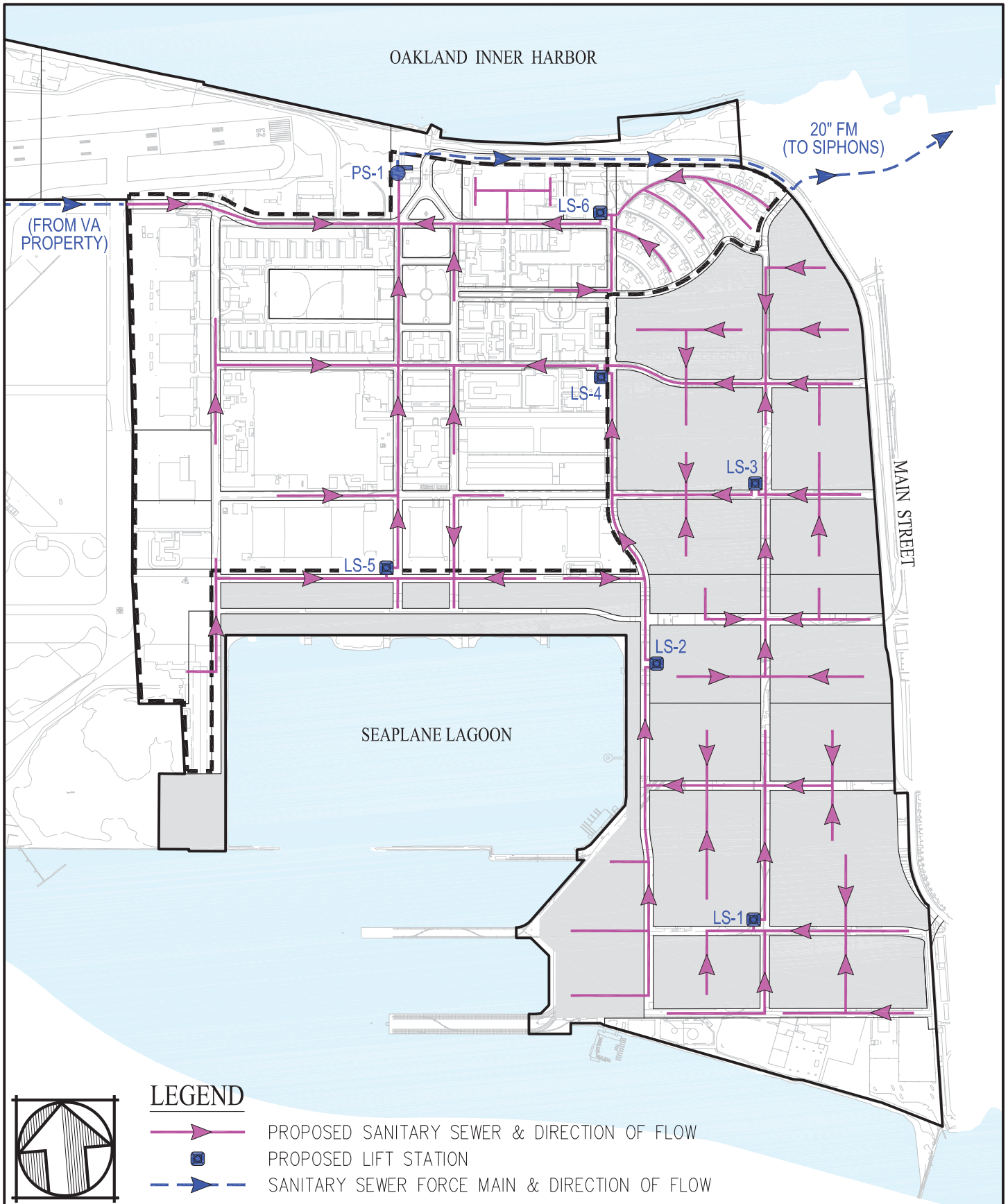
**FIGURE 35
PROPOSED SANITARY SEWER
REUSE AREAS INITIAL CONSTRUCTION**



LEGEND

-  PROPOSED SANITARY SEWER & DIRECTION OF FLOW
-  PROPOSED LIFT STATION
-  SANITARY SEWER FORCE MAIN & DIRECTION OF FLOW

**ALAMEDA POINT
MASTER INFRASTRUCTURE PLAN**

CITY OF ALAMEDA ALAMEDA COUNTY CALIFORNIA

DATE: JUNE, 2013 SCALE: 1" = 1,000'

Carlson, Barbee, & Gibson, Inc.

**FIGURE 36
PROPOSED SANITARY SEWER
ULTIMATE SYSTEM**

3. Proposed Off-Site Wastewater Transmission System Improvements

The existing off-site wastewater transmission facilities, Pump Station 1, 20-inch force main, Estuary siphon facility and the EBMUD Interceptor, have adequate capacity for the proposed wastewater flow generated by the full build-out of Alameda Point. There are no proposed improvements to these facilities as part of Alameda Point.

VII. STORMWATER SYSTEM

A. Topography and Precipitation

The existing elevations at Alameda Point are generally quite low. The highest existing elevations, just over 8 feet are located in the southeast portion of the site. The lowest elevations are less than 1 foot and are generally found in the northern portions of the site. These relatively low elevations have important implications in the design of stormwater and flood control infrastructure as discussed below.

Precipitation patterns along the central California coast are strongly influenced by a number of factors, with a marked tendency to greater rainfall intensities and associated high mean annual precipitation values in locations with higher elevations that are exposed to incoming storms, with the opposite effect in areas of low elevation. The low elevations at Alameda Point result in a mean annual precipitation of approximately 18 inches/year, which is much less than in the neighboring City of Oakland where rainfall totals are impacted by the East Bay Hills. In fact, isohyetal mapping by the Alameda County Flood Control and Water Conservation District shows that storm intensity and magnitude at Alameda Point can be expected to be among the lowest in the County, the only lower totals being found in the southern bayside areas that lie in the lee of the highest mountains of the San Francisco Peninsula.

Design storm information provided in the Storm Drain Master Plan (SDMP) for the City is based on a mean annual precipitation of 19 inches/year, slightly higher than that expected at Alameda Point. However, preliminary stormwater infrastructure design for Alameda Point uses the information from the SDMP for consistency, noting that the result will tend to be slightly conservative. On this basis, the design precipitation for the 10-, 25-, and 100-year 24-hour duration storm events are 3.2, 3.8 and 4.7 inches respectively.

B. Impervious and Development Areas

The eastern portions of the Project Site were densely developed, with the most intensely used areas located around the Seaplane Lagoon. Overall impervious cover is very high at approximately 83%, with large blocks of land having nearly 100% impervious coverage. Therefore, overall impervious coverage at the site is expected to decrease with redevelopment.

With respect to stormwater management planning at the site, it is important to distinguish between Development and Reuse Areas. In Development Areas, existing structures and facilities will be completely replaced. This allows ground elevations to be elevated during the redevelopment process. The greater difference in elevation between the ground surface in these areas and tailwater elevations in the Bay gives greater flexibility in stormwater system design and buffers the impact of potential sea level rise on such systems. This contrasts with the Reuse Areas, where constraints such as historical preservation, preclude completely replacing existing structures and modifying the existing street pattern and elevations. Therefore, Reuse Areas will generally be constrained to the existing elevations which in some areas are low, imposing immediate design considerations with respect to meeting prevailing storm drain standards and adaptively responding to sea level rise.

C. Soil Characteristics and Groundwater

The soils at the site are characterized by a shallow depth to groundwater, consistent with the low existing ground elevations. These high groundwater elevations significantly restrict the use of infiltration of stormwater into the ground as a stormwater management option at Alameda Point.

D. Tidal Characteristics

As pointed out previously, tidal characteristics are an important consideration at Alameda Point. The very highest tide levels associated with storm surge events can be high enough to cause localized flooding of the lowest-lying portions of the site under existing conditions. Additionally, all storm drain systems have to discharge to the Estuary or Bay against the tide elevations that prevail during any given storm event. This is generally not a problem for low tide conditions, but can be a significant factor limiting the conveyance capacity of existing and proposed storm drain lines during high tides.

Alameda Point experiences a diurnal tidal cycle that is typical of coastal California with two high and two low tide periods occurring each day. Important tidal datum information is included in Table 6 below, which shows the range between mean lower low water and mean higher high water is 6.6 feet. Several of the datum values are of direct relevance in stormwater infrastructure design. Most importantly, mean higher high water elevations are only slightly below the lowest ground elevations at the site. Therefore, localized flooding is a potential issue along much of the northern perimeter of the site whenever any significant rainfall coincides with the higher high tide peak, even without consideration of storm surge effects.

Higher tide elevations are also of concern. For example, the SDMP presents a thorough derivation of high tide values to be used in storm drain system design to account for the joint probability of very large storm events coinciding with storm surge events in the vicinity of Alameda. The calculated 25-year coincident peak tide elevation for this case is 1.7 feet, which is well above the lower lying elevations at the site. Likewise, the 100-year stillwater tide elevation is 3.6 feet, an elevation high enough to put portions of the site in a FEMA designated Special Flood Hazard Area (100-year floodplain).

Low tide elevations can also be important with respect to storm drain design. For example, constructing storm drain outfalls above the lowest tide elevations allows for easier routine maintenance inspections. For Alameda Point this would mean having outfall structure pipe inverts no lower than -5 feet, and preferably even higher.

Table 6 - Tidal Datum Elevations for Alameda Point

Tidal Datum	City of Alameda Datum
Mean Higher High Water	0.3
Mean High Water	-0.4
Mean Tide Level	-2.8
Mean Low Water	-5.2
Mean Lower Low Water	-6.3
Highest Observed Tide	3.3
100-Year Tide	3.6
25-Year Coincident Peak Tide	1.7

E. Existing Stormwater Management System

Stormwater runoff at Alameda Point is currently conveyed directly to outfalls by a storm drain system. The portions of the storm drain system within land owned by the City of Alameda are also owned and maintained by the City of Alameda. Whereas, the remainder of the existing storm drain system within land still owned by the Navy is owned by the Navy. The existing stormwater system was installed by the Navy starting over 70 years ago.

The system is currently operable, but does not meet current standards in several regards. These include notable capacity limitations and the fact that there is no stormwater quality infrastructure in place at present.

The majority of the existing system within Alameda Point is a gravity system that consists of pipelines, ranging in size up to 48-inches in diameter, inlets, junction boxes / manholes and outfalls to surrounding waters. See Figure 37 depicting the existing stormwater collection system and outfalls within Alameda Point. There are over 30 existing outfalls discharging stormwater runoff from the Project Site to the surrounding waters of the Seaplane Lagoon, Oakland / Alameda Estuary, and San Francisco Bay. Much of the existing infrastructure has deteriorated and has components that are in a state of disrepair. Many of the existing outfalls have missing or non-functioning flap gates allowing the tidal influences of the surrounding waters to impact the on-site system, causing flooding of low-lying areas as previously discussed. The existing low-lying areas that flood due to extreme high tides and/or storm events coinciding with high tides include areas along the northern shoreline and Main Gate, north and west edges of the Seaplane Lagoon and the Main Street / Ferry Terminal Parking Lot Entrance intersection. In fact, the exception to gravity drainage at the site is an existing stormwater pump station that was installed approximately 15 years ago to address flooding of the low lying portions of Main Street. This pump station is located at the northeast corner of the Project Site.

The existing drainage patterns of the Project Site are consistent with the existing topography. See Figure 38 depicting the existing drainage pattern and associated existing watersheds within Alameda Point. Stormwater runoff from the northern half of the Project Site, generally north of West Midway Avenue, is collected and conveyed by the existing system and discharged to the Oakland / Alameda Estuary through multiple outfalls along the northern shoreline. Stormwater runoff from the southeastern portion of the site is collected and conveyed by the existing system and discharged to San Francisco Bay through multiple outfalls along the southern shoreline. Stormwater runoff from the central portions of the Project Site is collected and conveyed to the Seaplane Lagoon through multiple outfalls along the Lagoon shoreline.

The watersheds for the existing stormwater system are almost exclusively limited to areas within the Project Site. However, there is one notable exception. Off-site runoff from a small watershed located along Main Street immediately to the north of Ralph Appezzato Memorial Parkway is collected and conveyed to the southwest where it outfalls the Seaplane Lagoon.

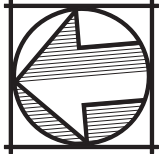
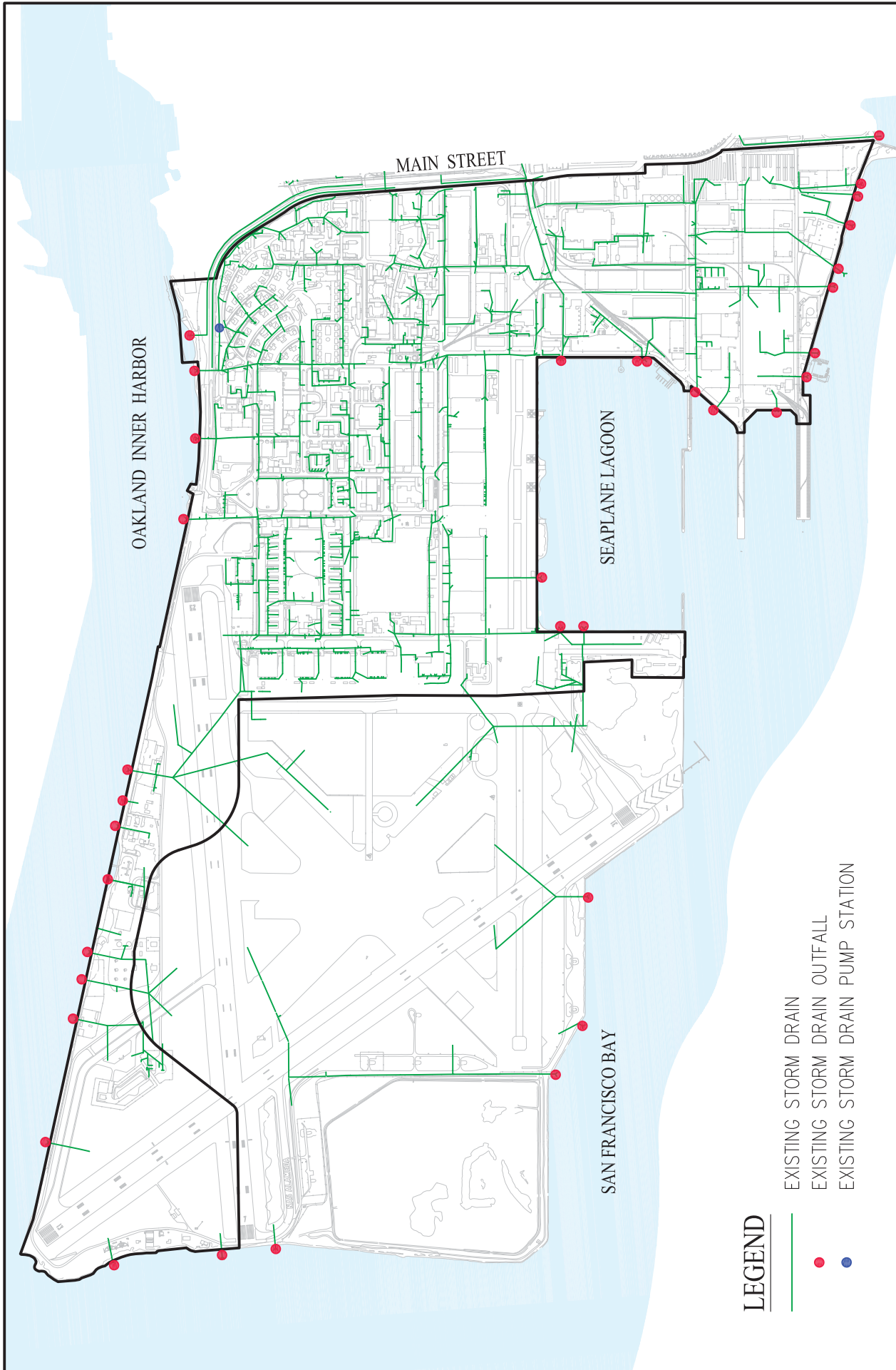
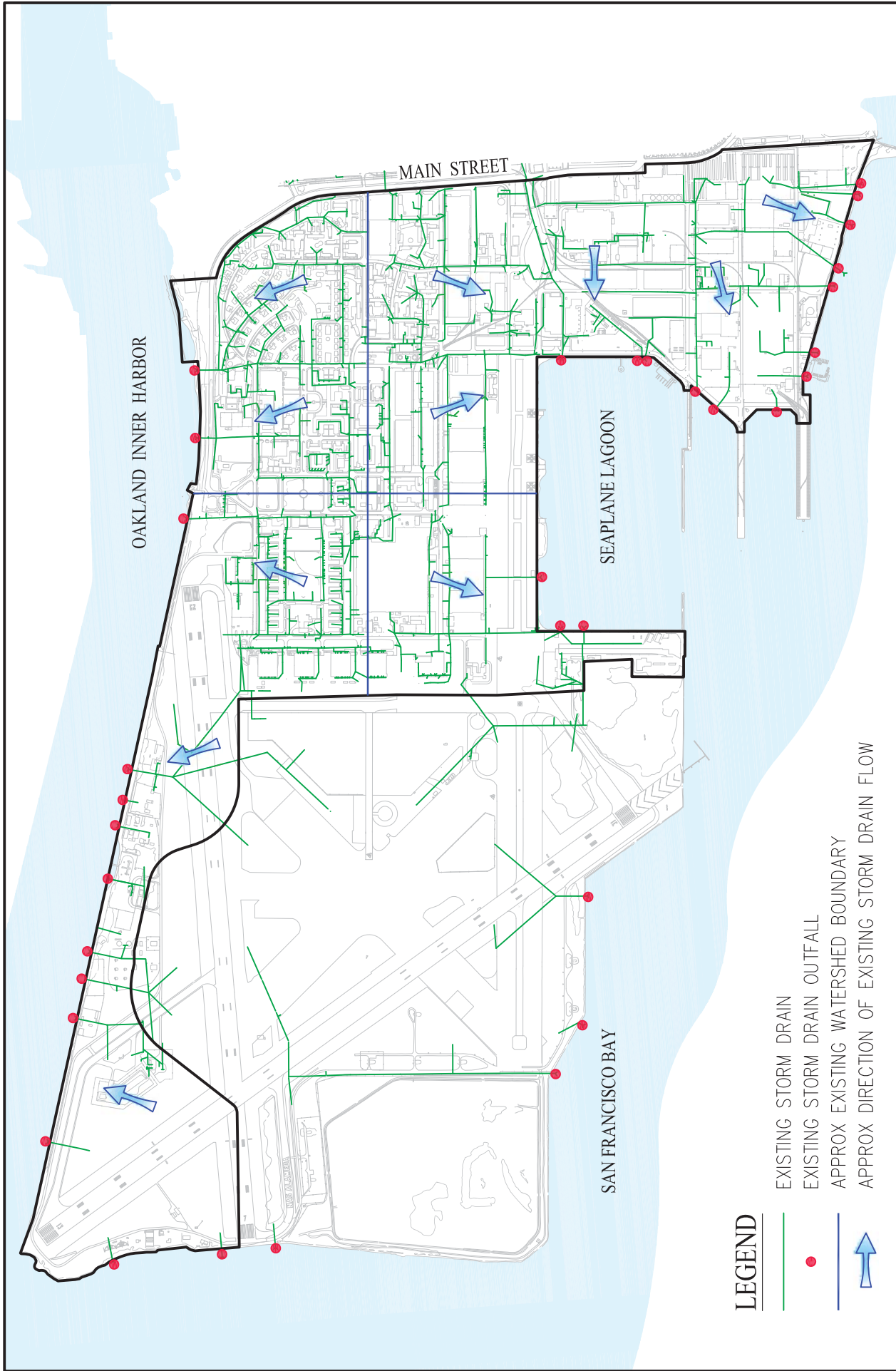

FIGURE 37 EXISTING STORM DRAIN & OUTFALLS

**ALAMEDA POINT
MASTER INFRASTRUCTURE PLAN**
CITY OF ALAMEDA ALAMEDA COUNTY CALIFORNIA
DATE: JUNE, 2013 SCALE: 1" = 1,500'
Carlson, Barbee, & Gibson, Inc.

G:\1087-10\ACAD-10\EXHIBITS\BASE CASE ALT - FIGURES\B_37_EX STORM DRAIN & OUTFALLS.DWG



LEGEND

-  EXISTING STORM DRAIN
-  EXISTING STORM DRAIN OUTFALL
-  APPROX EXISTING WATERSHED BOUNDARY
-  APPROX DIRECTION OF EXISTING STORM DRAIN FLOW

**ALAMEDA POINT
MASTER INFRASTRUCTURE PLAN**
 CITY OF ALAMEDA ALAMEDA COUNTY CALIFORNIA
 DATE: JUNE, 2013 SCALE: 1" = 1,500'
Carlson, Barbee, & Gibson, Inc.

**FIGURE 38
EXISTING WATERSHEDS**

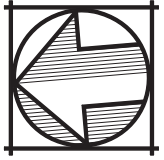

F. Proposed Stormwater Management System

A new stormwater collection system, owned and operated by the City of Alameda, will be installed at Alameda Point. The proposed system will integrate new pipelines, pump stations, multi-purpose basins, and outfalls with water quality treatment features designed to meet current City of Alameda, County of Alameda, and Regional Water Quality Control Board design criteria. The new stormwater management system will also be designed to address the potential impacts of future sea level rise through forward planning of adaptation strategies and infrastructure.

The proposed stormwater collection system will maintain the existing drainage patterns of the Project Site. Additionally, the proposed system will significantly reduce the number of outfalls to the surrounding waters in order to facilitate and minimize future maintenance obligations of the City of Alameda. Preliminary system design calls for a total of five outfalls, down markedly from over 30 outfalls at present. The proposed outfalls will be constructed at existing outfall locations to minimize potential environmental impacts associated with installation and operation of these facilities. Where used, stormwater pump stations will include redundant pump systems, alarms, and emergency backup power supplies to reduce the risk of flooding by ensuring high levels of reliability.

The new stormwater system will be built within all Development Areas. In the Reuse Areas, the existing system will initially remain in service with rehabilitation improvements such as repair or reinstallation of tide gates at existing outfalls. Eventually, as soon as there are available funds from development projects within the Reuse Areas, the existing system will be incrementally replaced. The installation of the downstream components, including trunk stormwater lines, multi-purpose basins, pump stations, and outfalls, will be prioritized. Ultimately, new stormwater management infrastructure will be incrementally installed over time throughout the Reuse Areas as well.

1. Development Areas

As discussed previously, large-scale areas of new construction are anticipated in the Development Areas. This will allow high existing ground elevations to be maintained, and even increased somewhat, and for early construction of an entirely new stormwater management system. The proposed system will include gravity storm drain pipes ranging in size from 12 to 60 inches in diameter and new outfall structures. These facilities will be installed within all backbone streets in the Development Areas. See Figure 39 depicting the proposed on-site stormwater collection system schematic within the Development Areas.

The installation of updated infrastructure, along with the higher ground surface elevations in the Development Areas, will allow for collection and conveyance of the 25-year design storm event consistent with City standards. Storm drain lines will drain by gravity to the respective outfall locations, which will be equipped with flap gates and energy dissipation to control discharge to the receiving waters. Storm drain pipes will be designed to accommodate settlement at locations where long-term differential settlement is considered possible.

Development Areas may also require future pump stations and/or multi-use stormwater basins as an adaptive response measure to future sea level rise. The pump station and multi-use basin sizes are inversely related, meaning that with a larger pump station the multi-purpose basin could be smaller or with a larger multi-purpose basin the pump station could be smaller. Additionally, the locations of the multi-purpose basins and pump stations depicted in the MIP are flexible and can be adjusted as the land use and open space plans for these areas are advanced.

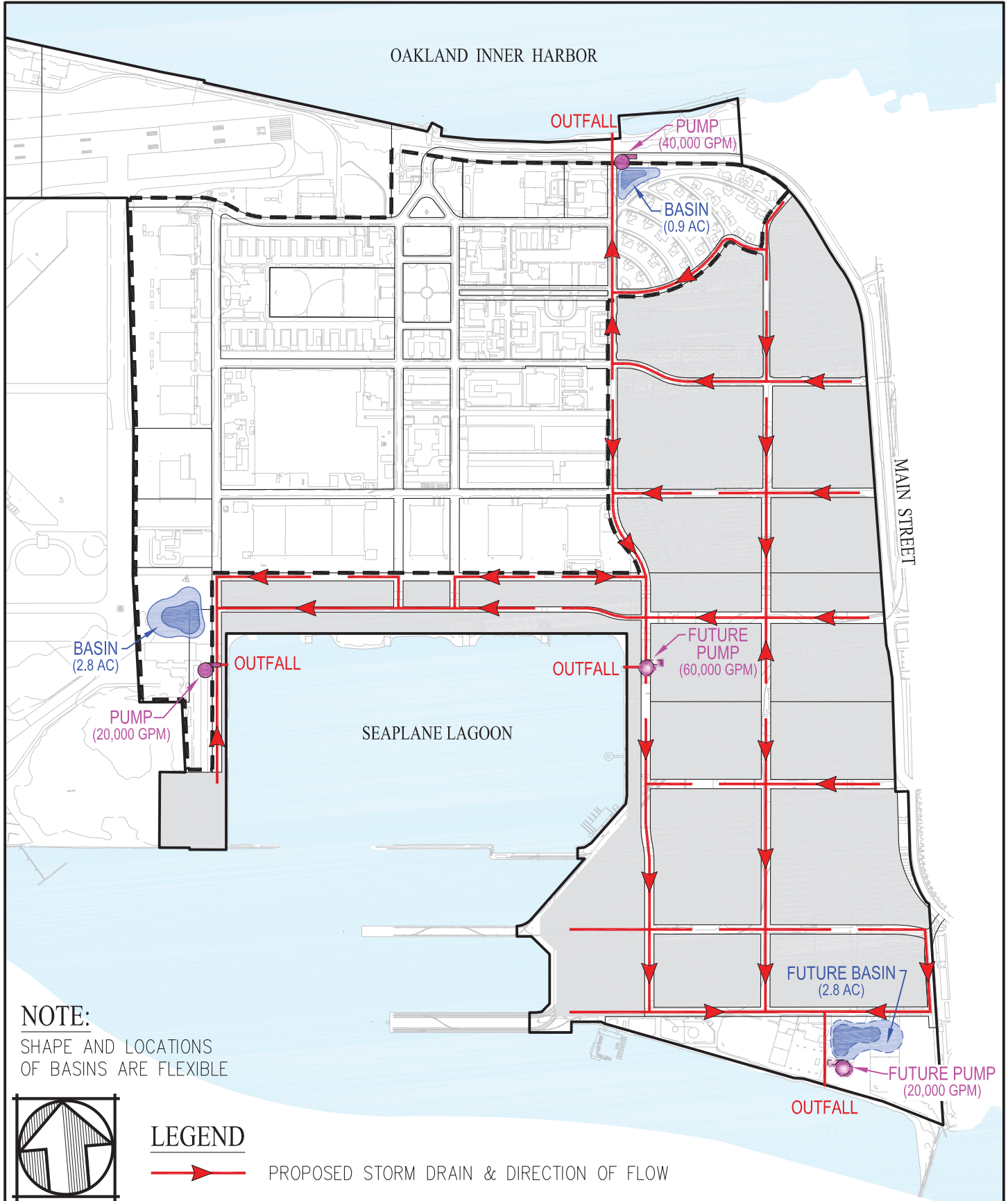

NOTE:
SHAPE AND LOCATIONS
OF BASINS ARE FLEXIBLE

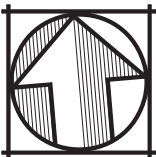

LEGEND

PROPOSED STORM DRAIN & DIRECTION OF FLOW

**ALAMEDA POINT
MASTER INFRASTRUCTURE PLAN**

CITY OF ALAMEDA ALAMEDA COUNTY CALIFORNIA

DATE: JUNE, 2013 SCALE: 1" = 1,000'

Carlson, Barbee, & Gibson, Inc.

**FIGURE 39
PROPOSED STORM DRAIN
IN DEVELOPMENT AREAS**

2. Reuse Areas

The Reuse Areas, with their constraints on building and street replacement, will require a stormwater management system that can function effectively with many areas of low ground elevation. These low elevations will require stormwater pump stations to meet City design standards. See Figure 40 depicting the ultimate stormwater collection system schematic within the Reuse Areas.

The Reuse Areas will initially continue to utilize the existing on-site stormwater collection system. The existing stormwater management system will be progressively improved through an enhanced maintenance program. The enhanced maintenance program will rehabilitate the existing system in a step-wise manner to address deficiencies. Specifically, the enhanced maintenance program will prioritize the installation of new tide valves on the existing outfalls. Additionally, each proposed development within the Reuse Areas will be responsible for investigating and documenting the condition of the existing stormwater infrastructure within that specific site. Any deficiencies identified will be addressed at that time and funded by that development project, to the satisfaction of the Public Works Director. Anticipated enhanced maintenance improvements include cleaning and lining of existing pipelines and manholes as well as required replacement of existing pipelines to address adverse flow conditions in areas that have settled. Additionally, each development project within the Reuse Areas will replace the stormwater facilities and construct water quality facilities inside each respective parcel. Until the existing system is replaced, existing low lying structures within the Reuse Areas may be required to obtain flood insurance if the existing structure is below the 100-year flood elevation. Any new construction of structures within the Reuse Areas during this interim period shall be required to be constructed 1-foot above the 100-year flood elevation.

As funds become available through a fee program, the existing backbone stormwater systems will be replaced. The installation of the new stormwater system within the Reuse Areas will be incremental. The City of Alameda will coordinate these incremental improvements to ensure they are implemented orderly. The downstream improvements, including multi-purpose basins, pump stations and outfalls shall be prioritized, in order to provide flood protection for the Reuse Areas that can address climate change. The remainder of the backbone system shall be installed from the downstream portions to the upstream portions of the system and connect to the adjacent on-site systems. See Figure 41 depicting the existing on-site stormwater collection system schematic within the Reuse Areas to initially be installed.

Ultimately, the enhanced maintenance program will lead to replacement of the entire stormwater management system and the construction of the flood protection facilities, including perimeter levees and floodwalls, new outfalls, multi-purpose basins and pump stations, within the Reuse Areas. The ultimate stormwater system will provide a system that fully complies with the City's 25-year stormwater design criteria as discussed below.

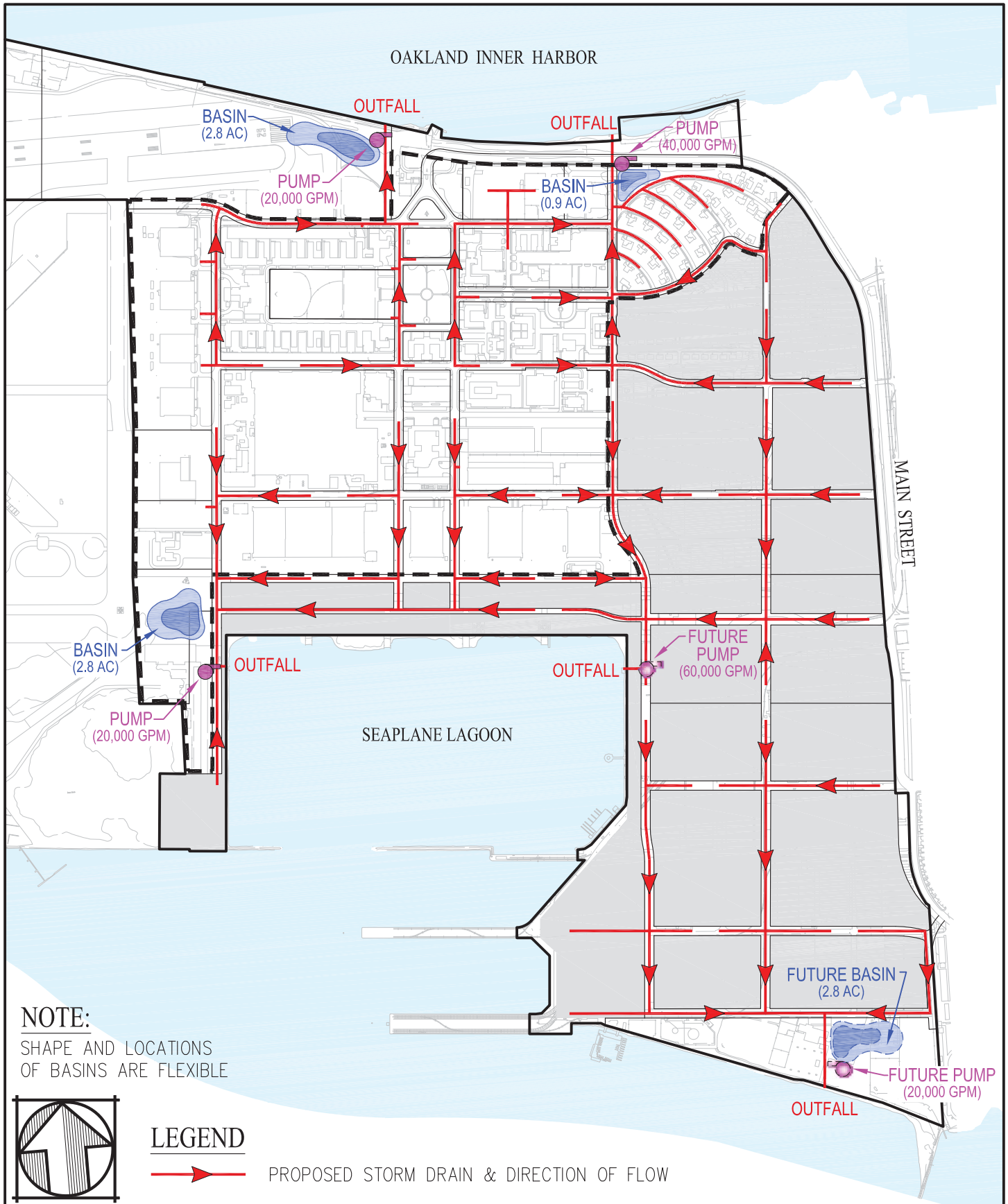

NOTE:
SHAPE AND LOCATIONS
OF BASINS ARE FLEXIBLE

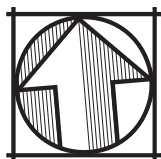

LEGEND

→ PROPOSED STORM DRAIN & DIRECTION OF FLOW

**ALAMEDA POINT
MASTER INFRASTRUCTURE PLAN**

CITY OF ALAMEDA ALAMEDA COUNTY CALIFORNIA

DATE: JUNE, 2013 SCALE: 1" = 1,000'

Carlson, Barbee, & Gibson, Inc.

**FIGURE 40
PROPOSED STORM DRAIN
ULTIMATE SYSTEM**

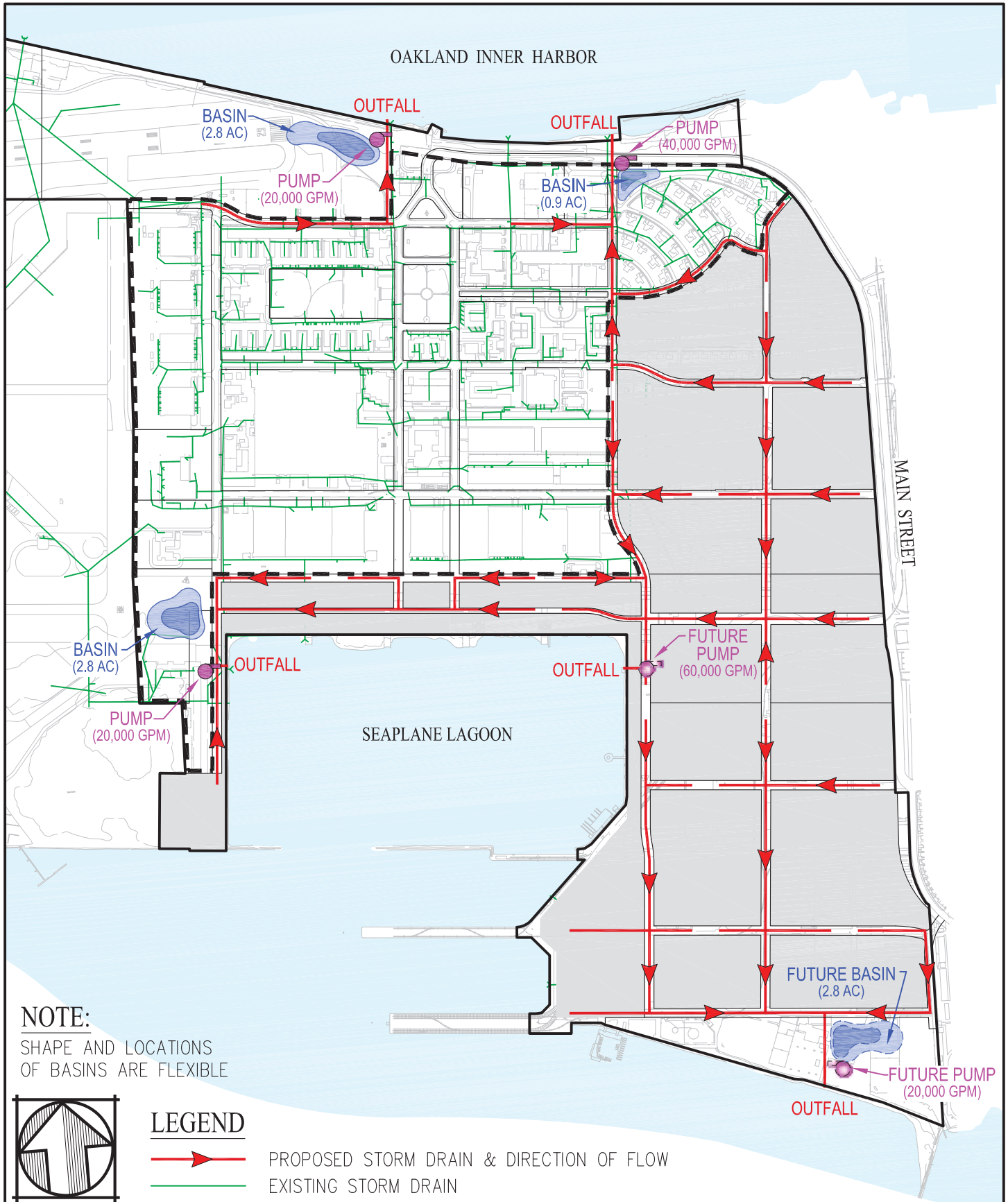

NOTE:
SHAPE AND LOCATIONS
OF BASINS ARE FLEXIBLE

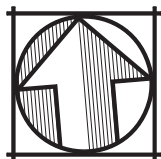

LEGEND

- PROPOSED STORM DRAIN & DIRECTION OF FLOW
- EXISTING STORM DRAIN

**ALAMEDA POINT
MASTER INFRASTRUCTURE PLAN**

CITY OF ALAMEDA ALAMEDA COUNTY CALIFORNIA

DATE: JUNE, 2013 SCALE: 1" = 1,000'

Carlson, Barbee, & Gibson, Inc.

**FIGURE 41
PROPOSED STORM DRAIN
REUSE AREAS INITIAL CONSTRUCTION**

3. Proposed Stormwater System Design Criteria

The design criteria used for the proposed stormwater system is consistent with the criteria specified in the City of Alameda's Standard Specifications and Design Criteria, dated April 1961, and the Storm Drain Master Plan (SDMP), dated August 2008. Specifically, Chapter 4 of the SDMP includes the design criteria for new stormwater systems within the City of Alameda. The following is a summary of the design criteria for the proposed stormwater collection system within Alameda Point:

Design Storm Event =	25-year design storm based on the balanced storm hydrograph developed in the SDMP
Beginning Water Surface Elevation =	25-year coincident tide based on the SDMP
Freeboard =	Hydraulic grade line within the system shall be no higher than 0.5-foot above the gutter elevation at any manhole or inlet
Minimum Cover to Pipelines =	Minimum cover to pipelines of 2 feet with approved pipeline materials

Additional design criteria will be followed to assure that the stormwater management system provides interior drainage protection for the 100-year storm event (in concert with exterior levees and floodwalls) consistent with FEMA requirements. This will include analyses and modeling demonstrating that runoff from the 100-year event (including longer durations than 24-hours) can be contained and conveyed to the Bay without flooding of structures. A detailed Operations and Maintenance Plan will need to be prepared as part of the design of any downstream facilities, such as outfalls, multi-purpose basins or pump stations. This plan will describe the interior drainage system with details regarding the associated infrastructure, maintenance plans and schedules, back-up facilities, and emergency protocols. Design to these criteria will remove the Alameda Point site from the Special Flood Hazard Area (100-year floodplain) in future FEMA flood hazard mapping efforts.

4. Adaptation to Sea Level Rise

As presented earlier in Section III, adaptation strategies for potential sea level rise will be an integral part of stormwater management planning at Alameda Point. Consistent with other infrastructure improvements at the Project Site, the following governing criteria will apply:

Initial Construction =	18-inches of sea level rise shall be added to the beginning water surface elevation
Adaptive Measures =	Shall be capable of accommodating up to 55-inches of future sea level rise

Several aspects of the planning process are important to note with respect to stormwater infrastructure design and sea level rise. First and foremost among these is the understanding that, with significant enough increases in sea level, safely and effectively discharging stormwater to the Bay will require some combination of on-site detention storage and pump capacity. Storage and pump capacity are complimentary infrastructural components. That is to say, larger on-site detention storage capacity reduces the required

pumping needs and vice versa. In fact, with sufficiently large storage capacity (e.g. equal or nearly equal to the total design storm runoff), stormwater pumping would not be required at all. Conversely, where space and land use constraints prevail, large detention storage facilities may not be practical and increased pump capacity will be required.

The second aspect of note has previously been discussed; the relationship of ground elevations and tidal tailwater elevations. Where ground elevations are high enough, conventional gravity storm drain systems can be designed to meet City conveyance criteria. However, as the difference between ground and coincident tide elevations decreases, the aforementioned need for storage/pumping becomes increasingly necessary if City criteria are to be met. The direct implication for Alameda Point is that even the initial construction sea level rise criteria (18-inches above current levels) will require storage/pumping facilities for the lower-lying Reuse Areas.

Finally, it is important to understand that adaptive management with respect to stormwater conveyance is not unbounded. Progressively more storage/pump capacity will be required for all the project watersheds as sea levels rise. However, once sufficient storage and/or pump capacity is in place to handle the entire runoff from the design storm without gravity outflow, tide levels in the Bay no longer matter significantly and further increases in sea level (even above the maximum adaptive criteria) can be readily addressed.

5. Preliminary Stormwater Modeling

In order to better define stormwater infrastructure needs as part of the MIP, preliminary stormwater modeling was completed for representative portions of the Project Site. The modeling was carried out using the MIKE-URBAN software package (DHI, Inc.), the same modeling platform that was used to develop the City's SDMP. Watershed parameterization and analysis explicitly followed the guidelines in the SDMP, including non-steady state routing of the balanced 25-year, 24-hour design storm against the variable 25-year coincident tidal tailwater conditions. This approach assures that stormwater infrastructure design at Alameda Point is consistent in all respects with that being applied elsewhere in the City.

The preliminary modeling focused on Watersheds B and E (see detailed discussions below) to bracket the range of anticipated constraints. See Figure 44 depicting the locations of Watersheds B and E. Watershed B is a prototypical Reuse Area watershed characterized by the lowest ground elevations within the Project Site, while Watershed E is representative of a Development Area watershed with markedly higher ground elevations. Model runs were carried out for a range of sea level rise conditions ranging from current levels and incrementing by 1 foot up to the higher adaptive management criterion of 55-inches above existing conditions. The model runs confirmed that the Reuse Areas such as Watershed B will need storage and pumping infrastructure to meet even the initial criteria. The addition of incremental sea level rise model runs provided an adaptive response infrastructure matrix, Table 7 that defines the various storage and pumping capacities associated with increasing sea level rise and identifies thresholds at which storage/pumping would be necessary for higher elevation areas such as Watershed E. The values presented in Table 7 are the total storage volume in acre-feet for the multi-purpose basins correlated to the pump capacity and varying amounts of sea level rise.

Table 7 - Preliminary Multi-Purpose Basin & Pump Sizes with Adaptive Measures

SLR (ft. above 2012)		Pump Capacity (GPM)						
Watersheds A-C	Watersheds D & E	None	10,000	20,000	30,000	40,000	50,000	60,000
0.0	3.0	0.7	0.3	0.2	0.1	No Basin	No Basin	No Basin
1.0	4.0	3.5	2.2	1.2	0.3	0.3	No Basin	No Basin
2.0	5.0	7.5	4.5	2.8	1.3	0.9	No Basin	No Basin
3.0		8.3	4.5	2.8	1.3	1.0	No Basin	No Basin
4.6		10.6	4.5	2.8	1.3	1.0	No Basin	No Basin

6. Proposed Multi-Purpose Basins and Pump Stations

The preliminary modeling efforts confirmed that multi-purpose stormwater basins and pump stations will be integral components necessary to ensure the reliability of the system and achieve the specified design criteria, effectively minimizing the risk of flooding within the Project Site.

The multi-purpose basins are only proposed for watersheds that include parks / open spaces uses near the downstream portion of the system. Basins will function in an “off-line” manner to enhance their multi-use functionality. Stormwater runoff will be routed to a vault structures at the downstream ends of the storm drain systems. Each vault structure will function as the wet well for the stormwater pumps in that system and will have an overflow weir connecting to the multi-purpose basin. The vault structures will be connected to the outfalls by both gravity lines and a force main from the pumps. This will allow discharge by gravity flow when storm events coincide with lower tide conditions. In this configuration, stormwater runoff will only enter the basins via the overflow weir when inflow to the vault exceeds the combined gravity and pumped discharge capacity. The off-line configuration will markedly reduce the frequency and quantity of runoff directed to each basin.

The basins will be designed to have two tiers, allowing for public use of the upper tier, potentially including active recreation facilities such as sports fields. The lower tier will be occupy roughly one quarter of the basin area and will be subject to more frequent inundation than the upper tier area, the latter can be managed such that it is flooded in only the largest storm events. Preliminary design calls for the floor elevation of the lower tier in each basin to generally be set 5 feet below the adjacent grade. The upper tier will encompass the remaining 75% of the basin area and will generally be only 3 feet deep in comparison to adjacent grade elevations outside the basin. See Figure 42 depicting a schematic of the two-tier multi-purpose basin. There will need to be appropriate signage and management of these areas to prohibit public uses during times of anticipated large storm events. Each basin will be drained (by gravity flow and/or pumping via the vault structures) within 24-hours of each storm event, limiting the periods of inundation to only a couple of days even if back to back storms occur. The multi-purpose basins are intended to be landscaped and under-drained to create a usable amenity for the community. The following design criteria will also be applied to the multi-purpose basins:

Maximum Side Slopes = 4:1

Freeboard = 1-foot to the 100-year water surface elevation

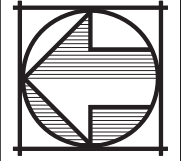
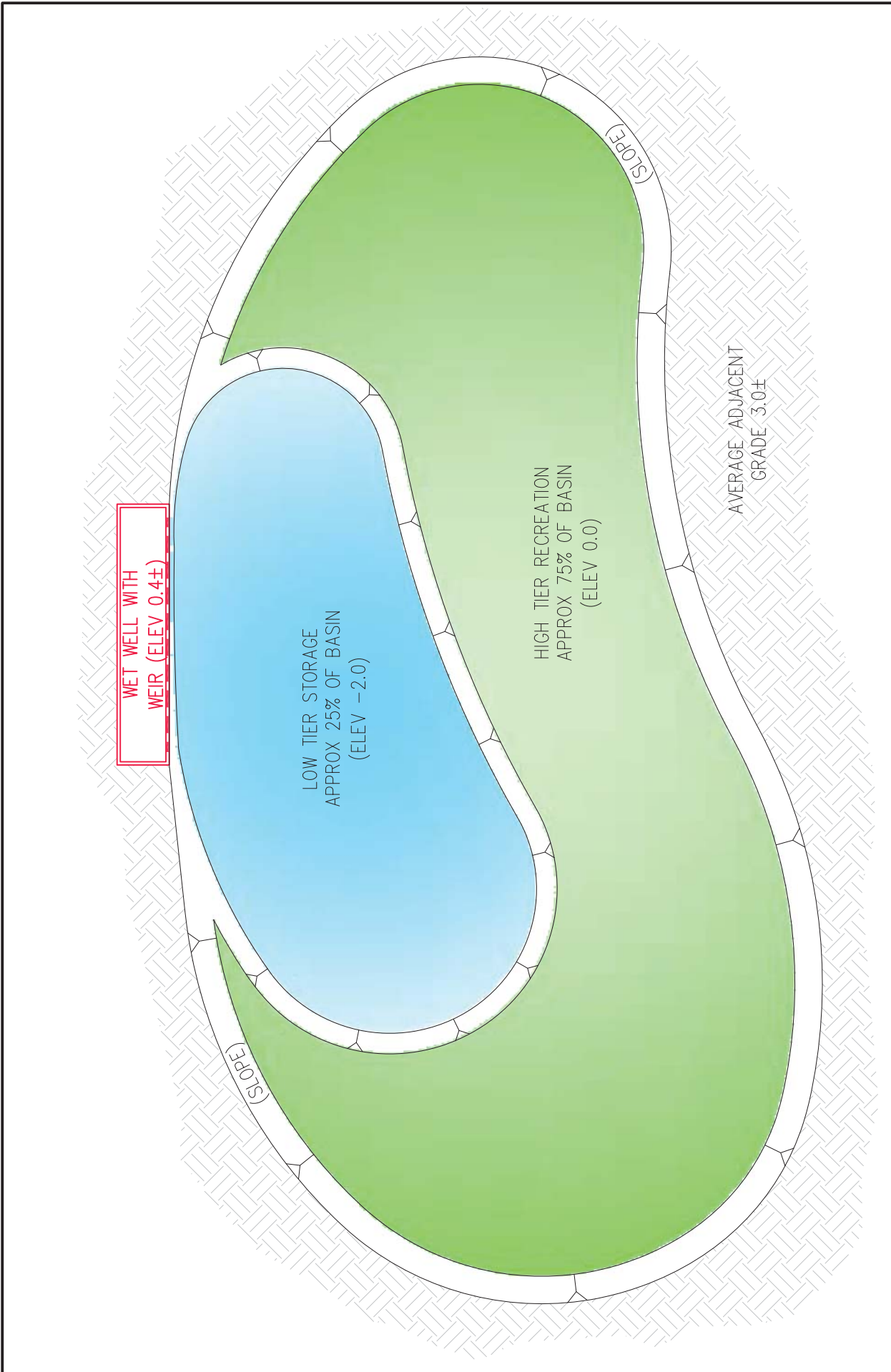

FIGURE 42
CONCEPTUAL TWO-TIER
MULTI-PURPOSE BASIN

G:\11087-10\ACAD-10\EXHIBITS\BASE CASE ALT - FIGURES\XB_42_CONCEPTUAL TWO-TIER BASIN.DWG

ALAMEDA POINT
MASTER INFRASTRUCTURE PLAN
CITY OF ALAMEDA ALAMEDA COUNTY CALIFORNIA
DATE: JUNE, 2013 NOT TO SCALE
Carlson, Barbee, & Gibson, Inc.

As mentioned previously, the vault structures will serve as the wet wells for required stormwater pumps. In areas where there is insufficient space available for a multi-purpose basin, the vaults and pumps will be sized to handle the peak design storm flow, necessitating much larger pumps. Future pump capacity needs are included in the sea level adaptation matrix. The southeast portion of the Development Areas (Watersheds D and E) will be at high enough elevations that they will only require a pump station and multi-purpose basin if sea levels rises more than approximately 3-feet. These facilities are to be planned as future improvements and will be implemented as part of the adaptive management of the site to address more than 18-inches of sea level rise.

7. Proposed Outfall Structures

The proposed outfall structures are to be located near existing stormwater outfalls. The outfalls will include provisions for both gravity pipes and the pump station force main pipe to discharge to the receiving waters. The proposed gravity pipeline outfall will be set at an elevation above the current mean low water, -5.0 feet, allowing for the conveyance pipelines to gravity drain at low tides and to facilitate inspection and maintenance activities. The force main pipe outfall will be set above the gravity pipeline at an elevation providing minimum or greater cover over the pipe. Outfall structures will be constructed on the shoreline and include rock slope protection designed to maintain a stable configuration. Interior to the outfall structures will be separate manholes with a backflow prevention tide valves and gate valves. This configuration will protect the tide valves from wave action, allow the manholes to be closed off from the Bay to facilitate maintenance of the tide valves, and prevent high tides from encroaching into the collection systems multi-purpose basins. See Figure 43 depicting the conceptual configuration of the proposed outfall structures.

8. Summary of Proposed Stormwater Systems per Watershed

As discussed previously, the proposed stormwater management strategy will maintain the existing drainage patterns of the Project Site. The overall proposed system will have 6 separate watersheds to encompassing the site. Some watersheds include only Development or Reuse Areas, while others include portions of both. See Figure 44 depicting the proposed watersheds established by the proposed stormwater system. The following is a description of the proposed stormwater management system anticipated for each watershed.

a. Watershed A

Watershed A encompasses the areas immediately to the north and west of the Seaplane Lagoon. This watershed includes approximately 148 acres and will discharge stormwater runoff through a newly refurbished outfall structure near the northwest corner of the Lagoon. The watershed includes portions of Development Areas along the frontage of the Seaplane Lagoon and Reuse Areas more interior to the Project Site, with the low-lying elevations of the Reuse Areas dictating the infrastructural components that will be needed. The ultimate stormwater system will include the installation of downstream facilities including main storm drain trunk lines, a multi-purpose basin, pump station, and the aforementioned outfall. The storm drain trunk lines will connect to the existing facilities in the Reuse Areas, as well as new storm drain lines within the Development Areas. The multi-purpose basin is proposed along the western edge of the Seaplane Lagoon and will cover an area of approximately 3 acres. The location and shape of this multi-purpose basin are flexible and should be determined in conjunction with the planning for the Seaplane Lagoon waterfront site. A pump station with the diversion vault structure will be installed at the multi-purpose basin and is anticipated to have a capacity of 20,000 gpm. An enhanced maintenance program will

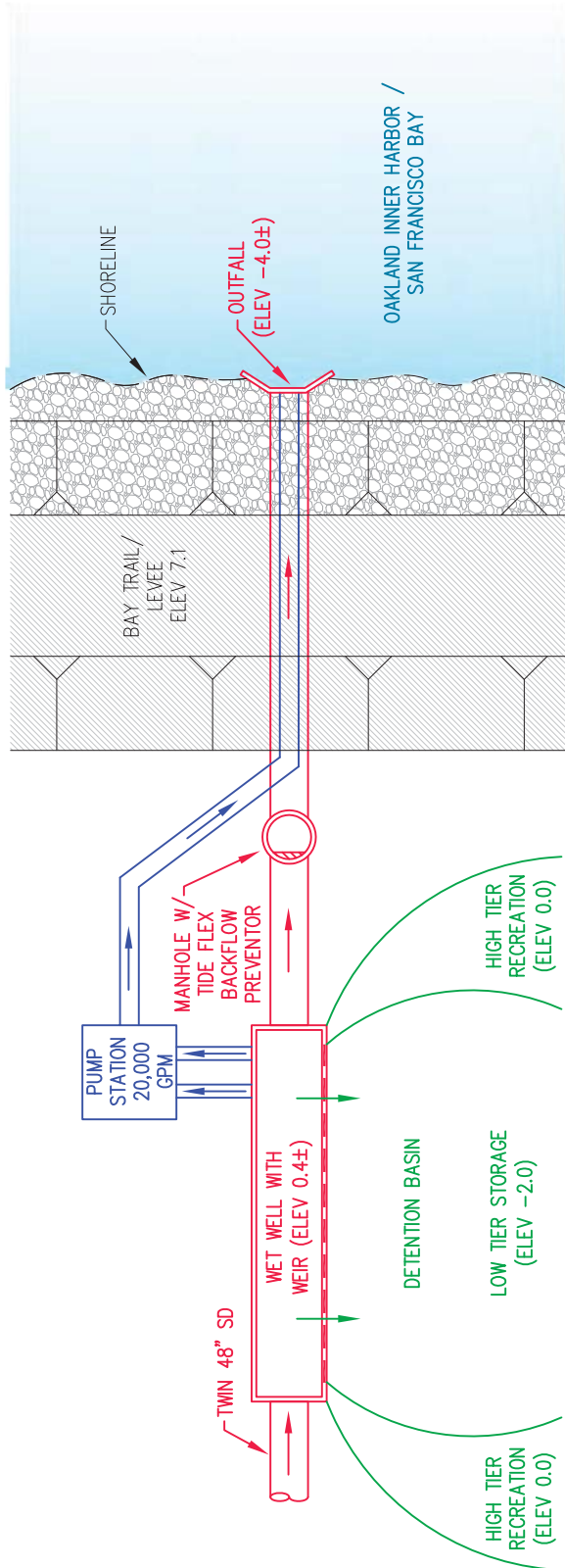

PLAN VIEW
NOT TO SCALE

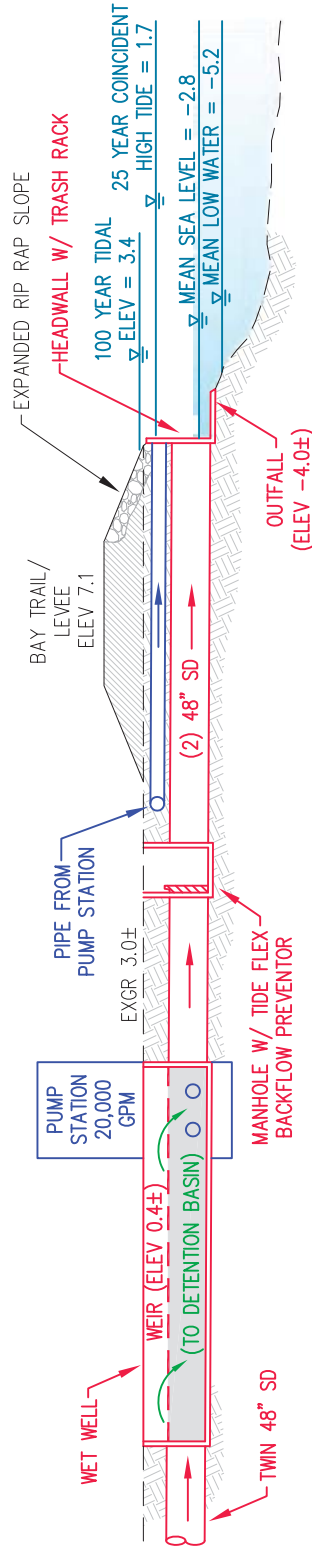

PROFILE VIEW
NOT TO SCALE

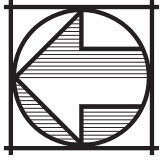
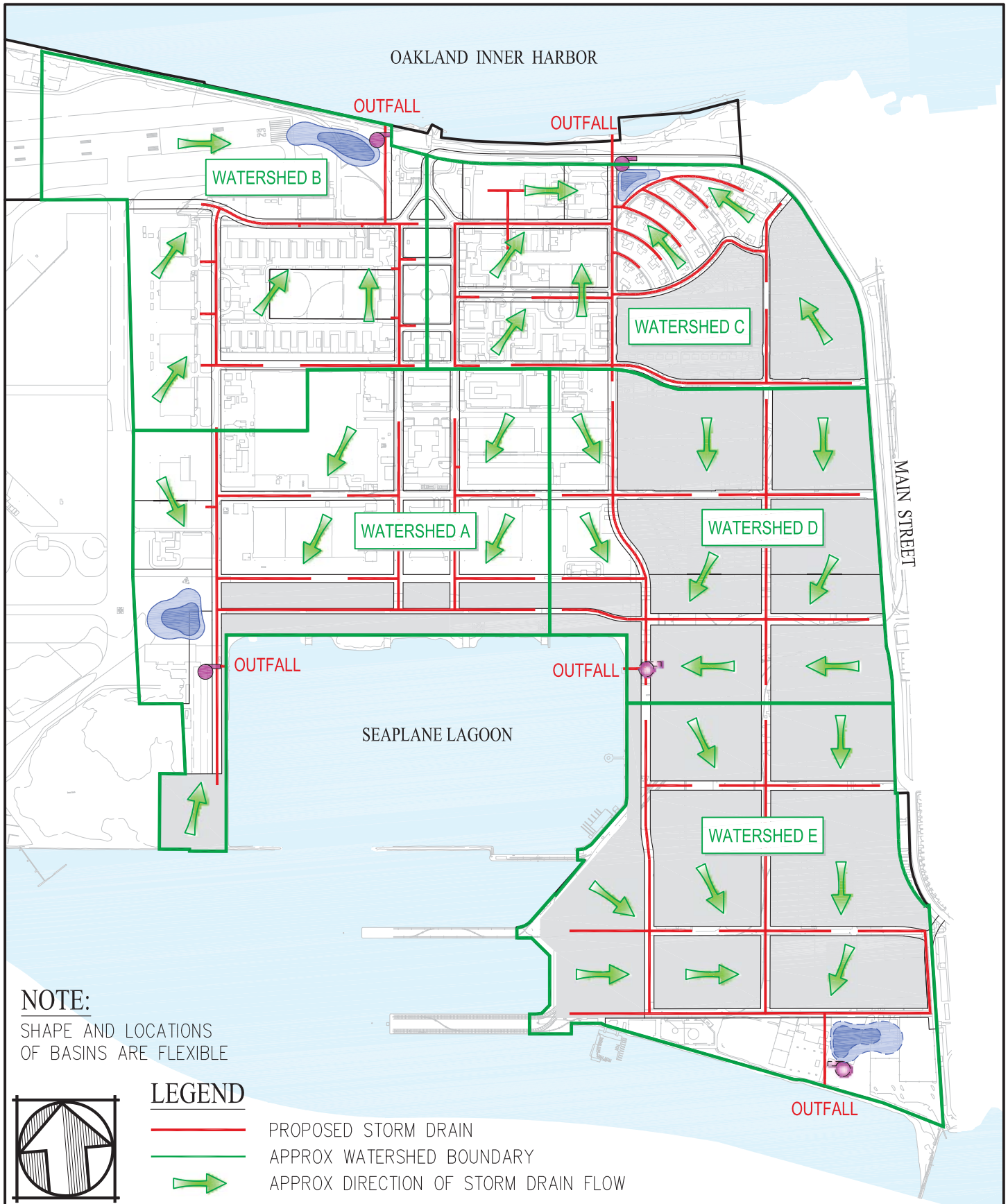
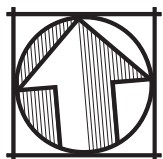

FIGURE 43 CONCEPTUAL BASIN / OUTFALL

ALAMEDA POINT
MASTER INFRASTRUCTURE PLAN
CITY OF ALAMEDA ALAMEDA COUNTY CALIFORNIA
DATE: JUNE, 2013 NOT TO SCALE
Carlson, Barbee, & Gibson, Inc.



NOTE:
SHAPE AND LOCATIONS
OF BASINS ARE FLEXIBLE



LEGEND

- PROPOSED STORM DRAIN
- APPROX WATERSHED BOUNDARY
- ➔ APPROX DIRECTION OF STORM DRAIN FLOW

**ALAMEDA POINT
MASTER INFRASTRUCTURE PLAN**

CITY OF ALAMEDA ALAMEDA COUNTY CALIFORNIA

DATE: JUNE, 2013 SCALE: 1" = 1,000'

Carlson, Barbee, & Gibson, Inc.

**FIGURE 44
PROPOSED STORM DRAIN
WATERSHEDS**

be implemented to rehabilitate the existing system within the Reuse Areas prior to the ultimate replacement and installation of the new stormwater collection system. Initial construction of the proposed stormwater system will include the installation of new storm drain lines in all backbone streets. This backbone system will include pipeline stubs to future Reuse parcels and connections to intercept existing on-site pipeline systems within Reuse parcels. Proposed construction within each Reuse parcel will be required to replace the existing stormwater facilities within that parcel, such that ultimately the entire existing system is replaced with a new system that meets current standards.

Providing 20,000 gpm of pumping capacity along with the 3-acre stormwater basin will allow the system to meet City standards and accommodate 55-inches of sea level rise and beyond. Watershed A will be levee protected from the flooding conditions described in the Flood Protection section and sufficient right-of-way will be maintained to increase levee height if sea level rise exceeds 18-inches.

b. Watershed B

Watershed B encompasses the northwestern quadrant of the Project Site. This watershed includes approximately 133 acres and the associated stormwater system will route runoff to a newly refurbished outfall on the Oakland / Alameda Estuary. The entire watershed area is comprised of Reuse Areas and includes the proposed Sports Complex site. As with Watershed A, the multi-purpose basin will have an area of approximately 3 acres and, in this case, is anticipated to be integrated into the Sports Complex site. The pump station is anticipated to have a capacity of 20,000 gpm. An enhanced maintenance program will be implemented to rehabilitate the existing system prior to the ultimate replacement and installation of the new stormwater collection system, which will be installed incrementally over time. Initial construction of the stormwater system will include the installation of downstream facilities including main storm drain trunk lines, a multi-purpose basin, pump station, and the aforementioned outfall, which is proposed for the northern shoreline of the Project Site, just west of the Main Gate. The proposed new stormwater system will include the initial installation of new storm drain lines in all backbone streets and will include pipeline stubs to intercept existing on-site drain lines within Reuse parcels. Proposed construction within each Reuse parcel will be required to replace the existing stormwater facilities within that parcel, such that the entire existing system is ultimately replaced with a new system that meets the design standards proposed herein.

Providing 20,000 gpm of pumping capacity along with the 3-acre stormwater basin will allow the system to meet City standards and accommodate 55-inches of sea level rise and beyond. Watershed B will be levee protected from the flooding conditions described in the Flood Protection section and sufficient right-of-way will be maintained to increase levee height if sea level rise exceeds 18-inches.

c. Watershed C

Watershed C encompasses the northeastern quadrant of the Project Site. This watershed includes approximately 112 acres and will route stormwater runoff to a newly refurbished outfall structure on the Oakland / Alameda Estuary. The areas within this watershed include Reuse Areas, including the neighborhood of the Big Whites, as well as Development Areas, but as in the case of Watershed A, the low-lying elevations of the Reuse Areas necessitate storage and pumping from the initial project stages. The ultimate stormwater system will include the installation of downstream

facilities including main storm drain trunk lines, a multi-purpose basin, pump station, and the aforementioned outfall, which is proposed for the northern shoreline of the Project Site, just west of the Main Street Dog Park. Space limitations constrain the size of the proposed multi-purpose basin to an area of approximately 1 acre, which will necessitate a somewhat larger installed stormwater pump capacity of 40,000 gpm.

An enhanced maintenance program will be implemented to rehabilitate the existing system within the Reuse Areas prior to the ultimate replacement and installation of the new stormwater collection system. Initial construction of the proposed stormwater system will include the installation of new storm drain lines in all backbone streets. This backbone system will include pipeline stubs to future Reuse parcels and connections to intercept existing on-site pipeline systems within Reuse parcels. Proposed construction within each Reuse parcel will be required to replace the existing stormwater facilities within that parcel, such that ultimately the entire existing system is replaced with a new system that meets current standards.

Providing 40,000 gpm of pumping capacity along with the 1-acre stormwater basin will allow the system to meet City standards and accommodate 55-inches of sea level rise and beyond. The Reuse Areas within Watershed C will be levee protected from the flooding conditions described in the Flood Protection section, with associated options for adaptively raising levee crest as needed to respond to sea level rise greater than 18-inches. The Development Areas within the watershed will be at an elevation above the required flood protection elevations for initial construction described in the Flood Protection section.

d. Watershed D

Watershed D encompasses the central and eastern areas portions of the Project Site. This watershed includes approximately 130 acres and will discharge runoff to the Seaplane Lagoon through a newly refurbished outfall near the northeast corner of the Lagoon. The majority of the development within the watershed is Development Area, with only a small component of Reuse Areas. The proposed stormwater system will include the installation of new storm drain lines in all backbone streets, as well as pipeline stubs to future Development parcels and stubs to intercept existing on-site pipeline systems within Reuse parcels. The downstream portion of this watershed is within the Waterfront Town Center Sub-District, where plans call for a higher density development. Therefore, it is anticipated that there will not be sufficient land available to construct a multi-purpose basin. However, elevations within the watershed are high enough to meet City design standards (with 18- inches of sea level rise) without initial construction of a fully equipped pump station. Accordingly, the initial backbone infrastructure improvements for this watershed will include construction of the pump station vault, which will function through gravity outfall until such time that sea level rises more than 18-inches above current levels. At that point incremental stormwater pump capacity will be installed up a total of 60,000 gpm to pump the peak system flows to the Lagoon.

Providing a refurbished outfall and pump station vault will allow for adaptive management of the system to continue to meet the City's 25-year conveyance standard. The Development Areas within Watershed D will have minimum grades above the required flood protection elevations for initial construction described in the Flood Protection section. However, a levee will need to be constructed if sea level rise exceeds 18-inches and stormwater pump capacity will need to be

installed up to a predicted maximum of 60,000 gpm, which would provide protection up to and beyond a sea level rise of 55-inches.

e. Watershed E

Watershed E encompasses the southeastern quadrant of the Project Site. This watershed includes approximately 158 acres and will route stormwater runoff to a newly refurbished outfall structure San Francisco Bay. The watershed consists entirely of Development Area. The proposed stormwater system will include the installation of new storm drain lines in all backbone streets. The system will also include pipeline stubs to future Development parcels. The initial construction will only require an outfall to be constructed to the Bay. The elevations of this watershed are higher than other areas within the Project Site, and therefore, do not require a multi-purpose basin or pump station to be installed at the time of initial construction. A pump station with capacity of 20,000 gpm and a roughly 3-acre multi-purpose basin will be required if the sea level rise exceeds approximately 3 feet. The proposed outfall for this watershed will be located along the southern shoreline of the Enterprise Park.

The Development Areas within Watershed E will have minimum grades above the required flood protection elevations for initial construction described in the Flood Protection section. The stormwater system can be adapted to accommodate sea level rise over 3-feet with the installation a pump station and multi-purpose basin. A perimeter levee will need to be constructed if sea level rise exceeds 18-inches and sufficient right-of-way will be maintained for that adaptive measure as well.

f. Northwest Territories / VA Developed Areas

The Northwest Territories / VA Developed Areas encompass the northwestern areas of Alameda Point. This watershed includes approximately 275 acres and discharges storm runoff to the Oakland / Alameda Estuary. It is comprised of open space areas, mostly passive with some active areas, abandoned airplane runways and the VA Developed Area. The VA Developed Area will install new outfalls along the northern shoreline, which will convey runoff from the VA Developed areas, adjacent abandoned runways, and open space areas. The proposed storm drain lines and outfalls from the VA Developed Areas will intercept any existing stormwater facilities and replace existing outfalls within their vicinity. The remaining open space areas within this watershed will utilize the remainder of the existing stormwater facilities, pipelines and outfalls.

The VA Developed Area will have minimum grades above flood protection elevations including 55-inches of sea level rise. The remaining Open Space areas and abandoned runways will remain at similar elevations as the existing conditions and will therefore not be protected from 100-year coastal flooding hazards or future sea level rise.

g. Off-Site Watersheds

The City's SDMP suggests a number of improvements to the Alameda Northside drainage area lying immediately to the east of Alameda Point. This drainage area is the largest in the City and has been subject to localized flooding issues due to capacity limitations in a number of locations. The prioritized 10-year improvements for the system call for disconnecting the western portions of the system at West Campus Drive and redirecting the runoff to an alternative outfall location to off-load the existing Arbor and Northside (Marina Village) Pump Stations. One proposed alternative

outfall location, and the one requiring the smaller amount of new storm drain line, is the northeast corner of the Seaplane Lagoon.

Modeling presented in the SDMP suggests that a new 72-inch diameter storm drain line would be required to meet a 10-year design storm standard to gravity outfall at this location. Construction of this alternative outfall location could be accommodated in the infrastructure planning for Alameda with adequate forethought, although the size of the line would potentially present challenges with respect to right-of-way and locating of other utilities. However, it is important to note that increasing the design standard of system for the off-site watershed to the 25-year event would likely require an additional terminal stormwater pump station (or installation of stormwater pumps earlier than otherwise needed at the Watershed D outfall). Providing 25-year protection including sea level rise of 55-inches would require an additional 60,000 gpm of pumping capacity above and beyond that previously cited for Watershed D.

An alternative to the configuration suggested in the SDMP is to upgrade the existing pump station off-site of Alameda Point at Third Street to improve this off-site watershed. A bio-retention basin could also be constructed near the existing pump station, within the old Alameda Belt Line corridor to provide water quality benefit for this existing watershed. In this alternative a force main would be constructed from this upgraded pump station to the west and entering Alameda Point. This would provide design flexibility within Alameda Point for the pipeline that the force main connects to and accepts this off-site flow.

The City will determine which option is preferred prior to the beginning of the detailed storm drainage design for Alameda Point. The City's Urban Runoff Fund would be required to fund these improvements.

9. Proposed Water Quality Treatment Measures

The Alameda Countywide Clean Water Program oversees the implementation of the Municipal Regional Stormwater NPDES Permit (MRP) that was issued for urban stormwater discharges from Alameda County, including the City of Alameda. The MRP outlines a number of regulatory goals and requirements for stormwater management for new development and redevelopment sites. The permit provisions require the implementation of Low Impact Development (LID) measures as outlined in Section C.3.c of the MRP. These measures include source control, site design, and treatment requirements to reduce the amount of stormwater runoff and improve the quality of the stormwater runoff.

The MRP identifies appropriate LID stormwater management measures such as rainwater harvesting and re-use, infiltration, evapotranspiration, and biotreatment, while emphasizing that biotreatment systems are only to be used where it is practically infeasible to utilize the other three cited measures. Alameda Point has been identified as practically infeasible for large-scale rainwater harvesting and infiltration by utilizing the Alameda Countywide Clean Water Program's Infiltration/Harvesting and Use Feasibility Screening Worksheet. Accordingly, biotreatment will be the primary method of accomplishing stormwater treatment within Alameda Point. The LID biotreatment measures that will be implemented throughout Alameda Point will include bioretention planters, street planters, bioswales, subgrade infiltration areas, permeable paving and any other treatment measures approved by the Regional Board. Permeable surfaces (pavement and concrete) have been installed as part of the adjacent Bayport development, however, because of shallow groundwater they were ineffective and had to be removed because they did not function properly. Implementation of these types of surfaces is not allowed unless with approval from the Public Works

Director and a determination that the groundwater elevation will not interfere with the functioning of these units. The following describes the water quality plan for the Development and Reuse Areas:

a. Development Areas

The new backbone streets will be constructed with water quality facilities that provide treatment for the runoff from the impervious areas within that street right-of-way. These streets are anticipated to include linear bio-retention planters, bioswales and street planters providing bio-filtration of stormwater within the landscape strips of the street cross section. The water quality improvements within the backbone streets will be phased to closely match the development phasing.

The on-site / in-tract areas of development parcels within the Development Area will be required to be designed with LID principles and treat the runoff interior to that parcel. This treatment can be accomplished by allocating and integrating water quality treatment measures within on-site / in-tract landscape areas. Development parcels also may implement on-site / in-tract rain harvesting systems, where feasible.

With implementation of the water quality measures in the backbone streets and on-site / in-tract development parcels, all runoff from impervious areas within the Development Areas will be treated in compliance with MRP. In case that it is determined by the City of Alameda that it is not feasible or practical for a development parcel to provide all of the necessary treatment for that respective parcel, then that development parcel may implement water quality improvements elsewhere, within Alameda Point, consistent with the “Alternative or In-Lieu Compliance” provisions outlined in Section C.3.e of the MRP.

b. Reuse Areas

Water quality improvements within the Reuse Areas will be implemented incrementally over time. Development applications or long term leases for Reuse parcels will be required to construct on-site water quality improvements to provide treatment for that Reuse parcel. At this time, the water quality treatment of these existing streets is exempt from the requirements of the MRP. However, as backbone streets are improved with the Reuse Areas, water quality improvements will be implemented, to the maximum extent feasible, to treat the runoff from that street.

c. Water Quality Certification

A water quality certification, Section 401, will be required from the Regional Water Quality Board (RWQCB) for activities within wetlands or below the ordinary high water line. This certification will be required for the outfall construction at Alameda Point. The project will need to demonstrate compliance with the water quality regulations of the MRP for the storm runoff from the Project Site. As described above, the implementation of the water quality improvements will be phased in the Development Areas and incremental in the Reuse Areas. Accordingly, it is anticipated that a site-wide water quality certification will be pursued for all outfalls and waste discharge requirements will be established for the site outlining how the water quality compliance will be achieved over time.

VIII. POTABLE WATER

A. Existing Potable Water System

1. Existing Potable Water Supply

Potable water is supplied to Alameda Point by EBMUD. EBMUD has supplied water to the Project Site since 1941. Historical records indicate that when the former NAS Alameda was in operation, the average daily demand of potable water consumed by the Project Site was approximately 2.8 million gallons per day (MGD).

EBMUD supplies potable water to the Project Site through the existing potable water distribution system within the Alameda street network east of Main Street. EBMUD owns and operates a 24-inch transmission water line that crosses the Oakland / Alameda Estuary near the Webster / Posey Tubes. This facility supplies water to the majority of the west end of the City of Alameda. EBMUD's distribution system, ranging in size from 6-inches to 16-inches in diameter, extends from this transmission main to Main Street. There is an existing 10-inch diameter pipeline within Main Street, north of RAMP, and 12-inch and 16-inch diameter pipelines within Main Street to the south between RAMP and Pacific Avenue. Alameda Point receives water via three large existing meters, two (2) 8-inch and one (1) 10-inch, which connect to these EBMUD pipelines in Main Street.

2. Existing Potable Water Distribution System

The existing potable water system within Alameda Point connects to the meters described above and distributes potable and fire water to all areas within the Project Site. This existing system was installed by the Navy and the majority of the system is over 60 years old. In 1986, the existing water system in the southeast portion of the Project Site was reconstructed and new pipelines were installed.

Historically, there were two distinct water systems at Alameda Point, a potable water system and a dedicated fire protection system. The dedicated fire protection system was designed as a high flow deluge system to provide very large fire flows for a short period of time, suitable to protect aircraft and aircraft related activities at the former NAS Alameda. This fire system included large pipelines, up to 24-inch diameter, and up to approximately 1.5 million gallons of on-site storage. The storage facilities included two elevated and two ground level tanks. The fire system also included an on-site pumping plant to boost available fire flows. There is no demand for this type of system since aircraft operations ceased at the Project Site. Additionally, this fire protection system was costly to maintain operable, the elevated tanks required seismic retrofitting and there was insufficient water circulation / turnover in this system resulting in water quality concerns. Therefore, this fire protection system has since been abandoned and fire protection has been converted to the existing potable water system.

The existing potable water system of pipelines ranges in size from 6-inch to 16-inch in diameter. The system is currently owned by the City of Alameda, as it does not meet the standards for EBMUD to accept it into their ownership and system. The existing system remains functional and is providing water service to the existing uses within the Project Site. However, this system is deteriorated, requires frequent maintenance and is not considered reliable. The existing water pipelines are commonly not located in existing or proposed street alignments and portions of the system are located underneath existing buildings. Additionally, the existing system is commonly shallow and does not have adequate cover resulting in pipeline breaks and leaks. EBMUD anticipates that there is a significant amount of potable water that is lost and wasted at the Project Site due to undocumented leakage.

The Project Site is within EBMUD's central pressure zone. A recent fire flow test was conducted on the EBMUD's existing system at the intersection of Stargell Ave and Main Street. This fire flow test indicated that the static pressure of the system is 71 psi and the residual pressure at 2,000 gpm is 66 psi.

Currently, EBMUD operates and maintains the existing water system on behalf of the City of Alameda through a Joint Powers Agreement (JPA). See Figure 45 depicting the existing on-site potable water system and meters that supply water to the Project Site.

B. Proposed Potable Water System

1. Proposed Potable Water Demand & Supply

The total estimate average daily demand of potable water at full build-out of the redevelopment of Alameda Point is approximately 2.06 MGD. The potable water demand for the various proposed land uses and each Sub-District are outlined in Table 8 through Table 10. These potable water demand factors do not account for the implementation of water conserving fixtures throughout the proposed buildings. The estimated demand includes 0.95 MGD of irrigation demand at the Project Site. This maximum demand does not assume the use of recycled water for the irrigation demand or for other permitted uses, such as toilet flushing within commercial buildings. The potable water demand will be decreased accordingly with the delivery and use of recycled water at the Project Site. Additionally, this development will commit to a range of sustainable strategies that achieve reductions in water consumption, which will further reduce the estimated water demand.

Table 8 - Potable Water Flow Generation Factors

Land Use	Flow Factor
Residential	280 GPD / Unit or 165 GPD / Unit
Commercial	0.084 GPD / SF or 0.15 GPD / SF
Hotel	100 GPD / Room
Park	3,040 GPD / Net Acre
Marina	22 GDP / Slip

Table 9 - Estimated Potable Water Demand (Buildout)

Land Use	Units	Square Footage	Acres	Estimated Flow (MGD)
Residential	1,425			0.38
Commercial		5,500,000		0.51
Hotel	300			0.03
Park			311	0.94
Marina	530			0.01
VA Development Area			75	0.19
Total Potable Water Flow:				2.06

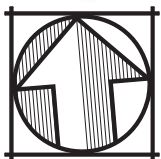
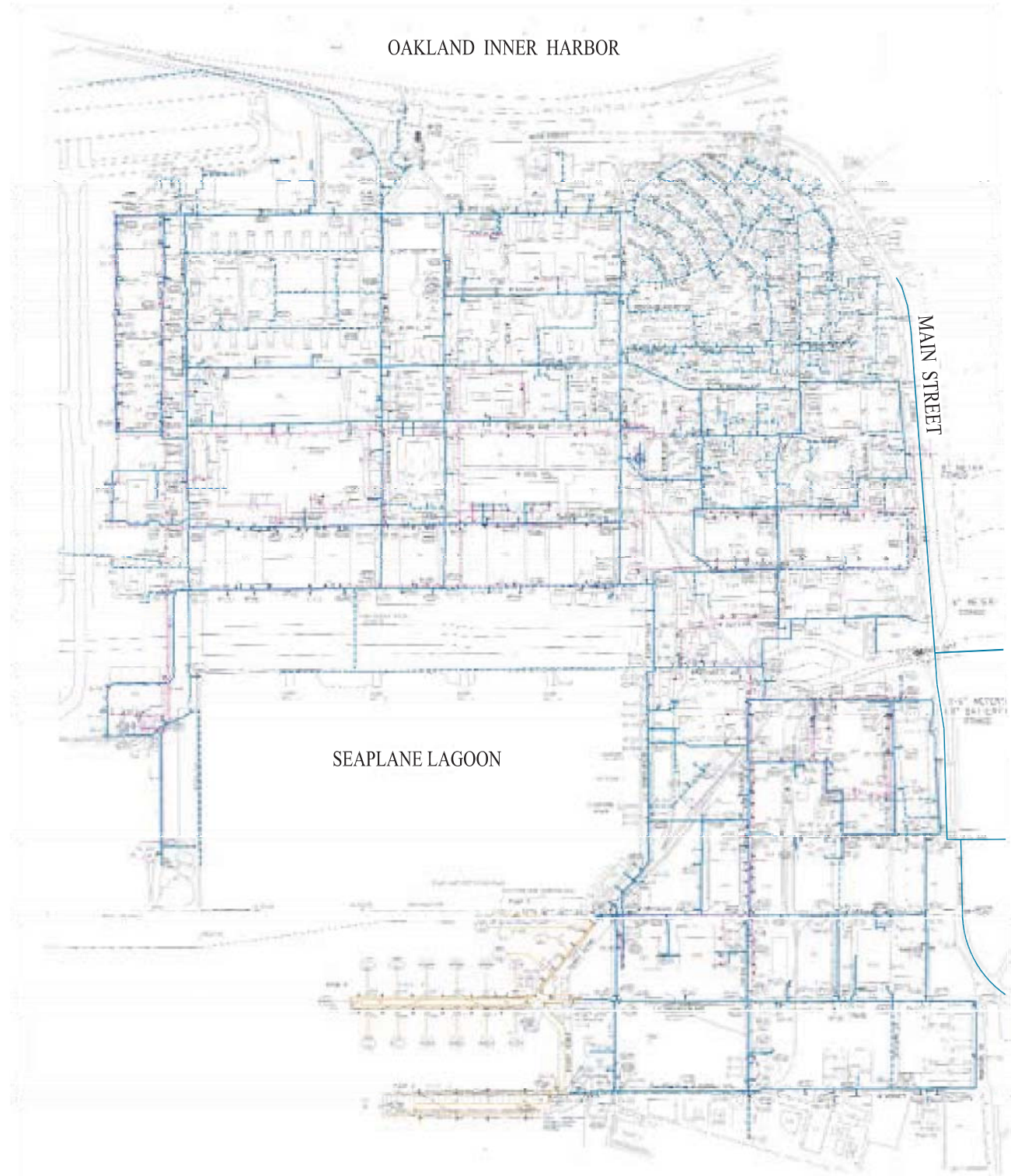

LEGEND	
	EXISTING WATER LINE
	NEW WATER LINE
	EXISTING SANITARY LINE
	NEW SANITARY LINE
	EXISTING STORM SEWER LINE
	NEW STORM SEWER LINE

MAPPING SOURCE:



**ALAMEDA POINT
MASTER INFRASTRUCTURE PLAN**

CITY OF ALAMEDA ALAMEDA COUNTY CALIFORNIA

DATE: JUNE, 2013 SCALE: 1" = 1,000'

Carlson, Barbee, & Gibson, Inc.

**FIGURE 45
EXISTING WATER SYSTEM**

Table 10 - Estimated Potable Water Demand Per Sub-District (Buildout)

Sub-District	Residential Flow (MGD)	Commercial Flow (MGD)	Hotel (MGD)	Park Flow (MGD)	Marina (MGD)	Total
Sub-District A	0.21	0.00	0.00	0.01	0.00	0.22
Sub-District B	0.11	0.08	0.00	0.02	0.01	0.22
Sub-District C	0.00	0.18	0.00	0.12	0.00	0.30
Sub-District D	0.05	0.25	0.03	0.15	0.00	0.48
Sub-District E	-	0.19*	0.00	0.65	0.00	0.84
Total:						2.06

*VA Property

EBMUD prepared a water supply assessment (WSA) for the General Plan Amendment (GPA) that was conducted for the Project Site in 2001. The proposed land uses and intensities in the GPA are very similar to those proposed in the Reuse Plan. The previous WSA indicated that EBMUD has a long history of supplying water to the Project Site and that the proposed redevelopment of Alameda Point only constitutes a change-in-use for an existing service area. The previous WSA concluded that EBMUD has adequate supply for the GPA. Similarly, EBMUD's Water Supply Management Program 2040 has included the water demand projections associated with the redevelopment of the site, maintaining adequate supply allocation to the Project Site.

EBMUD's available water supply for the proposed Reuse Plan will be confirmed through the concurrent EIR process, in which EBMUD will update their WSA.

2. Proposed Potable Water Distribution System

The proposed water distribution system will be owned and operated by EBMUD. The system shall be designed and constructed consistent with EBMUD's Standard Specifications for Pipelines 20-inches and smaller. The pipeline material for pipelines that are smaller than 12-inches in diameter will be polyvinyl chloride (PVC). Pipelines that are 12-inches in diameter and larger will be mortar-lined and plastic coated steel. Flexible connections or other flexible designs will be implemented at locations where differential settlement is anticipated.

The potable water distribution system will also provide fire water supply for the Project Site. The potable water system will be designed to provide the maximum daily demand plus a fire flow. Conservatively, the assumed fire flow design criteria is 3,000 gpm for 2 hours at a residual pressure of 20 psi from any three adjacent or reasonably nearby fire hydrants flowing at the same time.

The proposed water distribution system provides the maximum daily demand plus fire flow without storage facilities or booster pumps required.

Appropriate backflow prevention facilities will be required for all fire service connections and any connections (permanent or temporary) to the existing on-site distribution system.

a. Development Areas

A new potable water distribution system will be installed within the Development Areas at Alameda Point. The proposed distribution pipelines will connect to the existing EBMUD water facilities in Main Street. The existing water system will be replaced with the existing system in phases consistent with the development build-out. The proposed distribution system will range in size from 8-inch to 16-inch in diameter. The proposed water distribution facilities will be installed within all backbone streets providing reliable potable and fire water to all development parcels within the Development Areas. See Figure 46 depicting the proposed potable water system.

b. Reuse Areas

The Reuse Areas within Alameda Point initially will continue to utilize the existing potable water distribution system through an enhanced maintenance program. This program will incrementally replace the existing system. These incremental improvements will be coordinated through the City of Alameda and EBMUD to ensure the improvements are implemented orderly and addressing priority areas. The exterior pipeline loop within W. Redline Street, Monarch Street, W. Tower Avenue and Pan Am Street shall be prioritized. This improved loop will provide a more reliable system with adequate water pressure for fire protection within the Reuse Areas. Additionally, each development project within the Reuse Areas will replace the potable and fire water lateral serving that site.

Ultimately, the potable water distribution system within the Reuse Areas will be replaced. The proposed distribution system will be similar to the system proposed within the Development Areas, including new pipelines and appurtenances. The replacement of the potable water system within the Reuse Areas will be completed over time as described in the Phasing and Implementation Section XII.

C. Value Engineering Opportunities

A value engineering opportunity for the potable water system is to adjust the fire flow design criteria. The governing design parameter establishing the required pipeline sizes within the Project Site is the fire flows. The fire flow criteria assumed by the MIP is high in comparison to surrounding cities. Once more specific development details are available, such as sizes of proposed structures within defined areas of the site, this design parameter could be refined and reduced. The final fire flow design shall be confirmed with the City of Alameda Fire Department and be consistent with the current version of the California Fire Code. The current code allows for 50% reductions in the required fire flow when buildings are sprinklered, which is intended for the buildings at Alameda Point. Assuming reduced flow rates of 1,500 GPM typical residential construction and 2,500 GPM for commercial buildings, this would reduce the backbone infrastructure costs by approximately \$4.2 million.

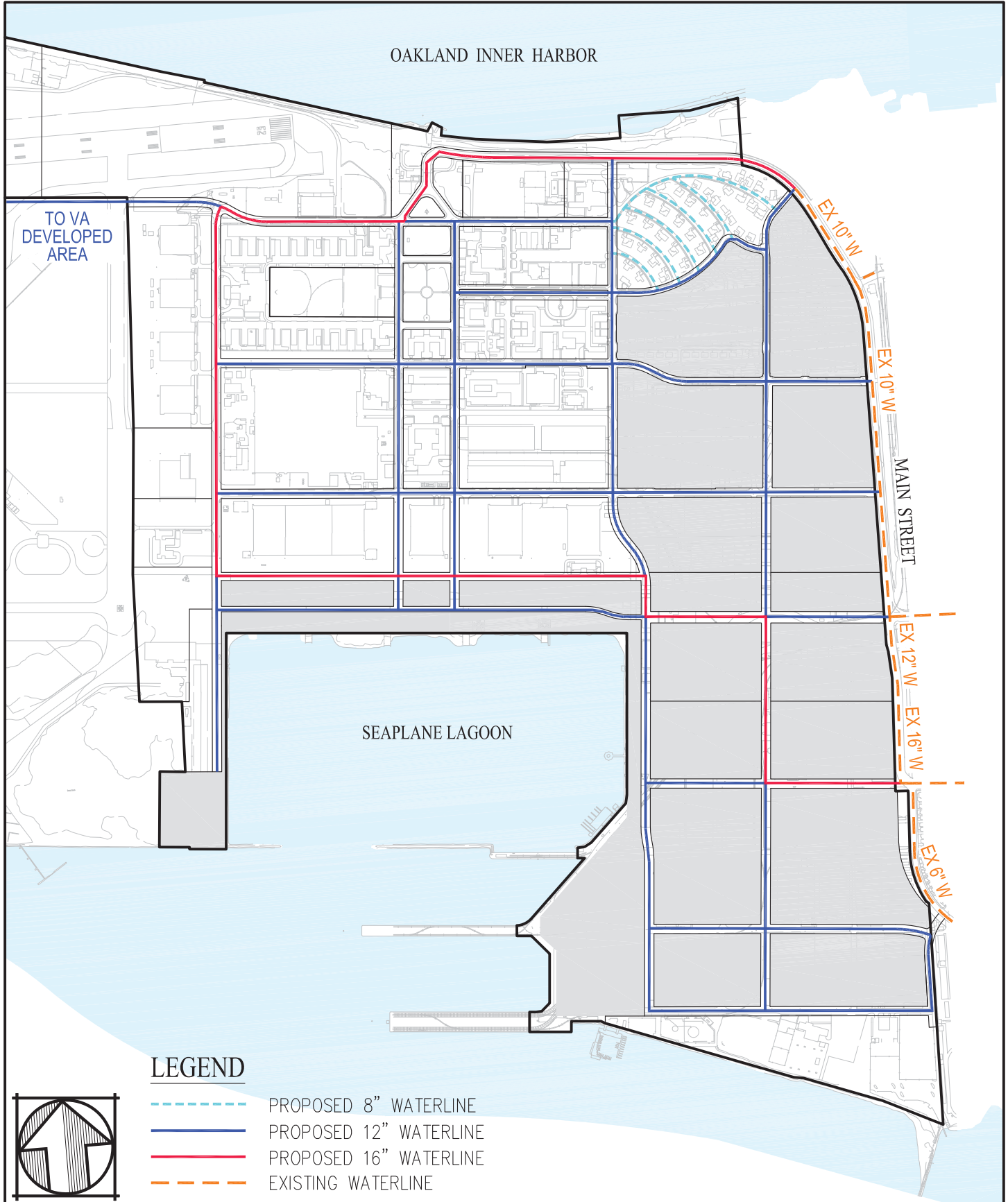

ALAMEDA POINT
MASTER INFRASTRUCTURE PLAN
 CITY OF ALAMEDA ALAMEDA COUNTY CALIFORNIA
 DATE: JUNE, 2013 SCALE: 1" = 1,000'
Carlson, Barbee, & Gibson, Inc.

FIGURE 46
PROPOSED ULTIMATE
WATER SYSTEM

IX. RECYCLED WATER

A. Existing Recycled Water System

1. Existing Recycled Water and Supply System

Currently, there is not an existing source of recycled water at Alameda Point. Accordingly, there are no existing recycled water distribution facilities within the Project Site.

B. Proposed Recycled Water System

1. Proposed Recycled Water Supply

EBMUD is implementing the East Bayshore Recycled Water Project, which currently supplies recycled water to portions of Oakland and Emeryville. EBMUD plans to extend their recycled water service to the City of Alameda, including Alameda Point, with future phases of this project. This multi-phase project will eventually supply an annual average of approximately 2.2 MGD of recycled water to portions of Alameda, Albany, Berkeley, Emeryville and Oakland.

EBMUD's source of recycled water for Alameda Point is generated at their Main Wastewater Treatment Plant (MWWTP) located at the eastern landing of the Bay Bridge. The recycled water facilities at the MWWTP utilize microfiltration and extra disinfection to produce recycled water that meets or exceeds the California Department of Health standards for unrestricted use.

Currently, EBMUD has existing operational recycled water distribution facilities in portions of West Oakland, near 7th Street and Jefferson Street intersection. The East Bayshore Recycled Water Project will eventually construct a recycled water supply line from these facilities in West Oakland, across the Oakland - Alameda Estuary, and into the western portions of Alameda. Alameda Point will likely connect to the recycled water facilities installed with the Bayport project, in order to connect to EBMUD's reliable supply. See Figure 47 depicting the existing and planned future facilities associated with EBMUD's East Bayshore Recycled Water Project.

2. Proposed Recycled Water System and Uses

As a key component of the Project's sustainable objectives to reduce potable water consumption and demand, a new recycled water distribution system will be installed at Alameda Point. A network of recycled water pipelines will be constructed within the proposed rights of ways of the backbone streets and will range in size from 6 to 12 inches. The recycled water facilities will be designed and constructed in accordance with EBMUD's regulations, standards and specifications.

The proposed recycled water system at Alameda Point will include a backbone network of pipelines throughout all Sub-Districts. This network of facilities will allow for continued growth of recycled water uses and flexibility for the Development and Reuse Areas to utilize this resource. The system will also extend to all anticipate large open space or park facilities, such as the Northwest Territories, Sports Complex and Enterprise Park areas. See Figure 48 depicting the proposed recycled water system.

The recycled water usage at Alameda Point will supplement and minimize the potable water usage. The anticipated uses of recycled water within the Project include landscape irrigation, wetland restoration support and irrigation, plumbing fixtures in dual-plumbed buildings and industrial processes. The recycled

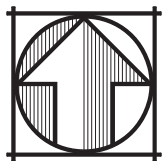
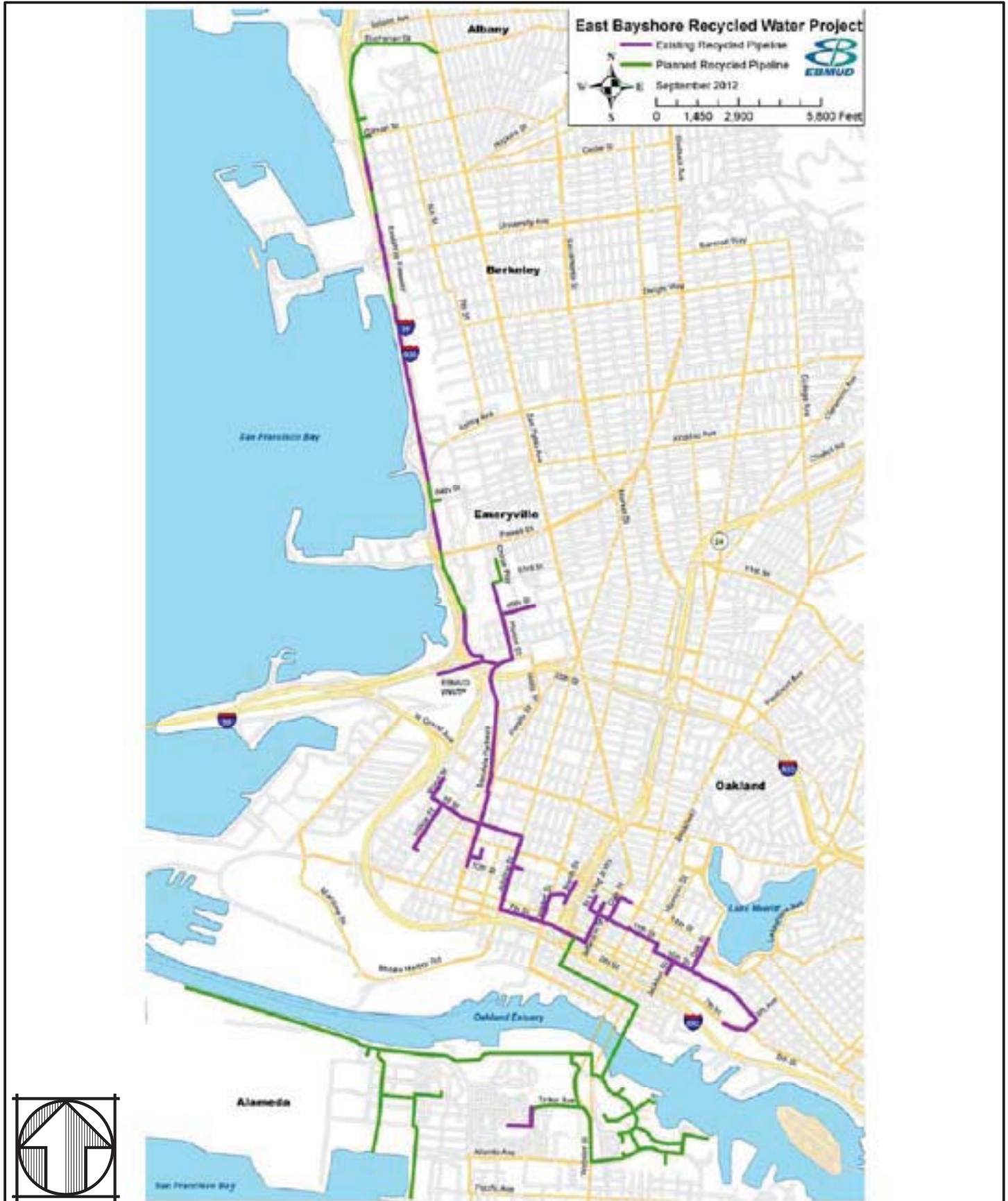

**ALAMEDA POINT
MASTER INFRASTRUCTURE PLAN**
CITY OF ALAMEDA ALAMEDA COUNTY CALIFORNIA
DATE: JUNE, 2013 NOT TO SCALE
Carlson, Barbee, & Gibson, Inc.

**FIGURE 47
EBMUD EAST BAYSHORE
RECYCLED WATER PROJECT**

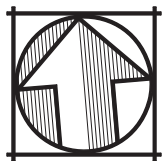
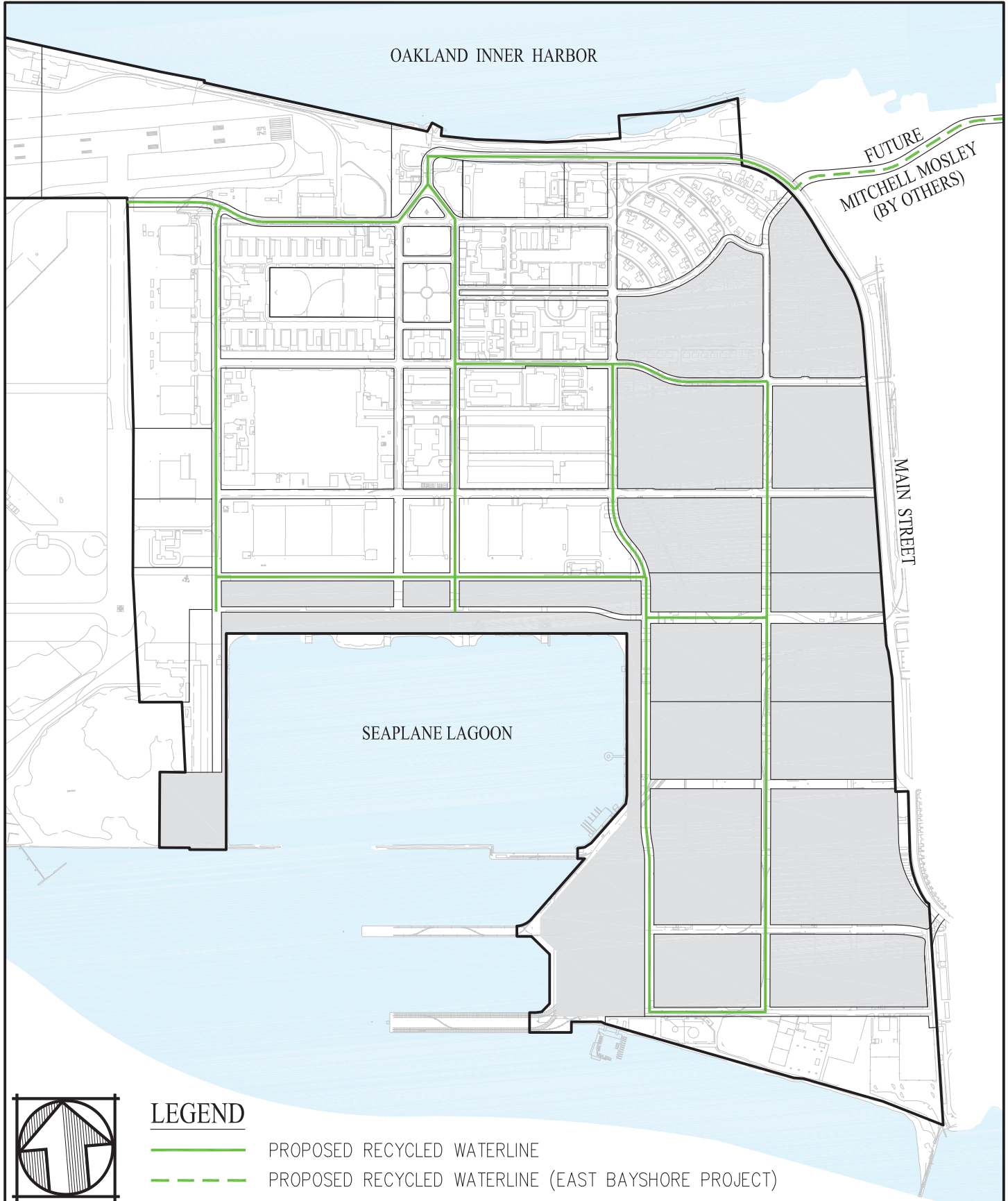

LEGEND

- PROPOSED RECYCLED WATERLINE
- - - PROPOSED RECYCLED WATERLINE (EAST BAYSHORE PROJECT)

**ALAMEDA POINT
MASTER INFRASTRUCTURE PLAN**

CITY OF ALAMEDA ALAMEDA COUNTY CALIFORNIA

DATE: JUNE, 2013 SCALE: 1" = 1,000'

Carlson, Barbee, & Gibson, Inc.

**FIGURE 48
PROPOSED
RECYCLED WATER**

water demand to provide irrigation to the proposed public open space areas within the Project Site is estimated to be 0.95 MGD. This is the largest expected demand for recycled water at Alameda Point and supply to these areas will be prioritized. All other proposed uses of recycled water will need to confirm available supply with EBMUD at the time of that project application.

There is potential that the EBMUD East Bayshore Recycled Water Project will not have extended recycled water supply to the western portions of Alameda by the commencement of construction of the Alameda Point backbone infrastructure. The proposed recycled water system will be installed regardless so that recycled water can be distributed throughout Alameda Point once EBMUD's supply is available. Additionally, under this scenario dual water services, potable and recycled, will need to be installed to all public open spaces and other uses that anticipate utilizing the recycled water once it is available. Potable water will be utilized at these locations until the conversion to recycled water use is complete.

As described above, the recycled water usage throughout the Project Site will reduce the potable water consumption. Utilizing recycled water for the irrigation demand of the large public open spaces planned within the Project Site will reduce the potable water demand by 0.95 MGD.

C. Value Engineering Opportunities

The largest anticipate demands for recycled water are the irrigation to landscape and wetland restoration areas and industrial processes. A value engineering opportunity is to limit the recycled water backbone system to only provide recycled water service to the areas within the Open Space and Adaptive Reuse Sub-Districts. This would reduce the backbone infrastructure costs by approximately \$1.8 million.

X. DRY UTILITIES

The dry utilities at Alameda Point include electric power, natural gas, communications and cable television.

A. Electric System

1. Existing Electric System

Alameda Municipal Power (AMP) owns and operates the existing electric power facilities at Alameda Point and throughout the City of Alameda. The existing electric system at Alameda Point consists of 115kV transmission, 12kV and 4kV distribution facilities. Electricity is supplied to the Project Site via the existing overhead 115kV transmission facilities along Pacific Avenue to the east, which turn north on Main Street and enter Alameda Point and connect to the Cartwright Substation near the Skyhawk / 11th Street intersection. The overhead 115kV transmission line continues north on Main Street and connects to NCPA Combustion Turbines twin peaking generators located north of the linear park & trail along Main Street.

The Cartwright Substation is a critical component of the existing electric system and is intended to remain in service throughout the redevelopment of Alameda Point. The substation provides local electric distribution to Alameda Point and portions of the surrounding areas to the east. Cartwright is a 115/12.47kV substation, equipped with two 33/44/55 MVA transformer banks. Nine active 12.47kV, 600 Amp underground distribution feeders (electric main lines) exit the substation to the west, providing local electric service throughout the Project Site. 600 Amp and 200 Amp looped underground distribution circuits provide feeds to local unit substations and existing customers throughout the Project Site. Unit substations located in strategic areas of the Project Site provide switching and/or protection for the various 12kV electric main lines. See Figure 49 depicting the existing electric system and associated key components

2. Existing Electric System Disposition and Capacity

AMP estimates that the Cartwright Substation has an existing electric capacity for a maximum demand of approximately 50 MVA. The substation can be upgraded to increase the electric capacity, if necessary. The upgrades would most likely include a transformer and bus and breaker improvements within the substation.

The electric transmission system facilities, 115kV pole lines, providing electricity to Alameda Point will support an additional electric demand of approximately 80 MVA.

The existing electric system is operable and provides electricity to the existing tenants within the Project Site. The Cartwright Substation is in acceptable condition to AMP and will be preserved. The existing 115kV overhead electric transmission lines along Main Street and connecting to the Cartwright Substation will remain overhead, but may be relocated to accommodate adjacent street improvements or developments if determined necessary. The existing electric distribution facilities on the piers were recently replaced and will remain.

The majority of the existing electric distribution system meets current codes and standards; however there are reliability issues within portions of the Project Site.

The locations of the existing distribution facilities are commonly outside of existing streets, and are within future Development areas.

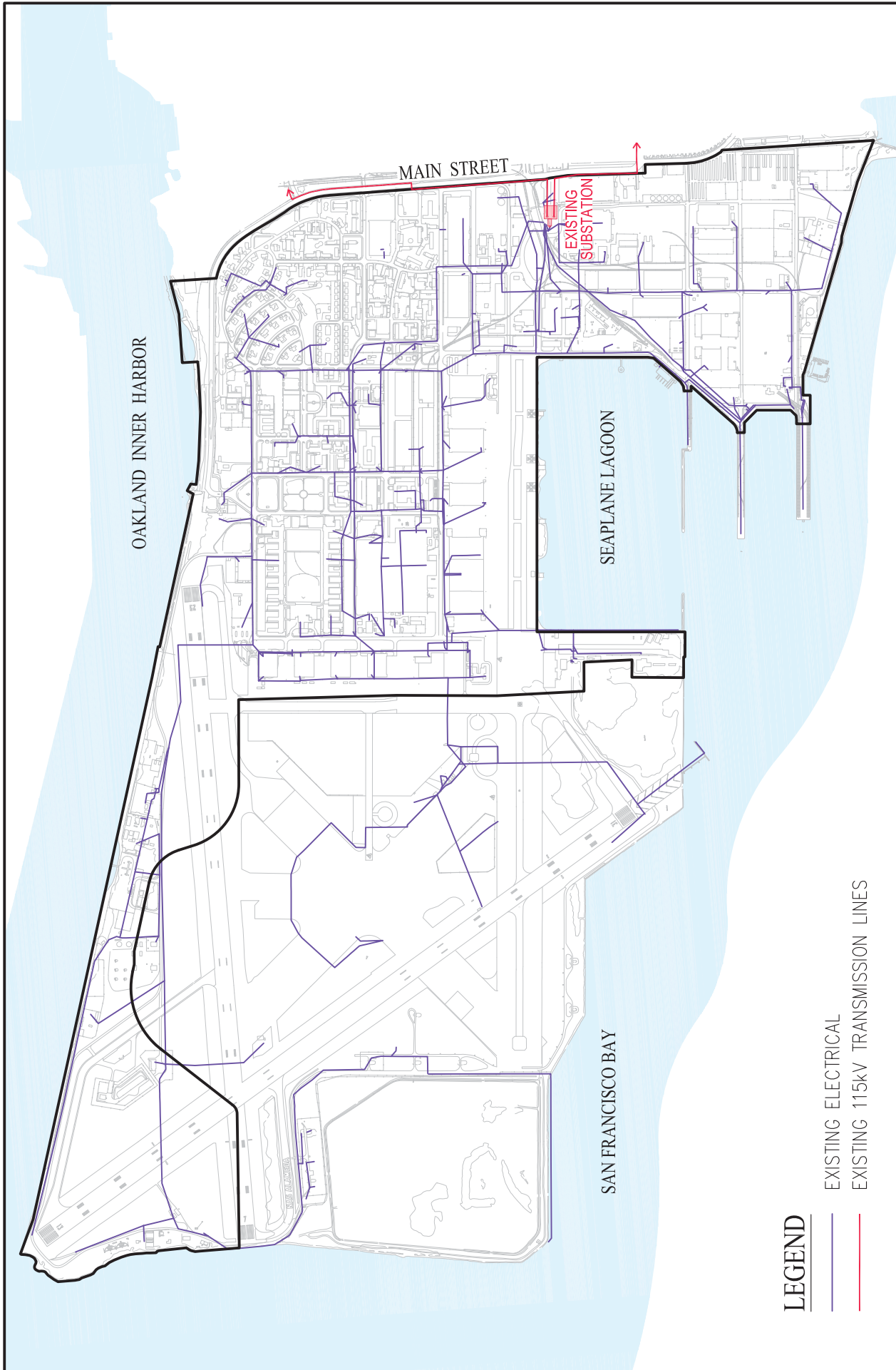

LEGEND

- EXISTING ELECTRICAL
- EXISTING 115kV TRANSMISSION LINES

**ALAMEDA POINT
MASTER INFRASTRUCTURE PLAN**
 CITY OF ALAMEDA ALAMEDA COUNTY CALIFORNIA
 DATE: JUNE, 2013 SCALE: 1" = 1,500'
Carlson, Barbee, & Gibson, Inc.

**FIGURE 49
EXISTING ELECTRICAL SYSTEM**

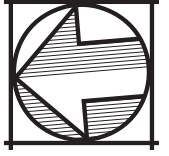

3. Proposed Electric Demand

The estimated total coincident electric demand for the ultimate redevelopment of Alameda Point is approximately 40 – 50 MVA. See Table 11 for a summary of estimated electric demands associated with the build-out of the Community Reuse Plan. The estimated demand is based on historical electric utility load data for the various proposed land uses in the local climate zone. The existing transmission facilities and Cartwright Substation have adequate capacity for the Project's estimated ultimate electric demand.

Table 11 - Estimated Electric Demand (Buildout)

Land Use	Units	Square Footage	Acres	Estimated Loads (MVA)
Residential	1,425			4.3
Commercial		5,300,000		36.4
Retail		200,000		2.5
VA Development Area			75	3.0
Total Electrical Load:				46.2

If additional capacity is necessary to accommodate proposed use within Alameda Point that exceeds the available capacity, equipment additions and improvements can be implemented at the Cartwright Substation to increase the available capacity. Other capacity upgrades and system protection / automation could be developed with input from AMP on an as needed basis.

Large industrial or other types of uses with high electric demands may require additional electric capacity. These types of demands would be in excess of about 4 MVA, and would likely require to be served at Primary Voltage (12.47 kV). This proposed use and associated electric demand would need to be evaluated and coordinated with AMP.

4. Proposed Electric System

The existing 115kV overhead transmission facilities will remain and continue to provide electric power to the Project Site. The 115kV pole lines directly east and connecting to the Cartwright Substation will be preserved. There is an existing easement, approximately 140-foot wide, in favor of AMP for this area, which will be preserved restricting the potential land uses to landscaping or parking areas. The 115kV pole lines along the west side of Main Street will remain but may be relocated to eliminate conflicts with proposed street improvements or development sites. The new 115 kV transmission lines, where they are relocated to, must be constructed and energized prior to removal of the existing lines.

The Cartwright Substation will be preserved and remain as a key component of the proposed electric distribution system.

a. Development Areas

From the Cartwright Substation, a new underground electric distribution system will be installed with the Development Areas. This new electric system will replace the existing electric system in phases consistent with the development build-out. The proposed electric distribution system will consist of new underground conduits, vaults, boxes, and pads; which will accommodate 15kV rated cables, transformers, switches and other utility distribution equipment including its SCADA communication monitoring and controls. The existing nine (9) electric main lines emanating

from the west side of the Cartwright Substation will be replaced with approximately six (6) new main lines. These main lines will require a utility corridor and reserved easement in aggregate, approximately 40-feet wide, to assure utility compliance for minimizing exposure and maintaining separation of circuits to avoid mutual heating of conductors. See Figure 50 depicting a conceptual configuration of the electric utility corridors and easements near the Cartwright Substation.

From the main lines, the electric distribution facilities will be installed within all backbone streets within the Development Areas. The electric conduits and cables will be placed in a joint utility trench. This trench will also accommodate the Pacific Gas & Electric (PG&E) natural gas, telephone, cable television, possible ancillary fiber optic cable systems and street light facilities. The proposed electric system and joint trench will be constructed in accordance with AMP's rules and regulations as outlined in their Material and Installation Criteria for Underground Electric Systems, latest version. See Figure 51 depicting the schematic proposed joint trench system at Alameda Point.

Some of the existing unit substations may remain if they do not conflict with other proposed utilities, streets or Development areas. Specifically, the existing unit substations, Substation #12 and Substation #14, near the piers will likely remain and provide service for the MARAD uses on the piers. The unit substations map also be used for underground trunk loop systems in the Development Areas.

b. Reuse Areas

The Reuse Areas within Alameda Point initially will continue to utilize the existing electrical distribution system through an enhanced maintenance program. This program will be administered by the City of Alameda / AMP and will rehabilitate the existing system to address deficiencies. Each proposed development within the Reuse Areas will be responsible for investigating and documenting the condition of the existing distribution facilities directly adjacent to that specific site. Any deficiencies identified shall be address at the time of that development. Additionally, each development project within the Reuse Areas will replace the transformer and electrical service to that site.

Ultimately, the electrical distribution system within the Reuse Areas will be replaced. The proposed system will be similar to the system proposed within the Development Areas, constructed in a joint utility trench. Similarly, the unit substations at preserved buildings within the Reuse Areas will likely remain and be served from the proposed distribution system. The replacement of the electrical system within the Reuse Areas will be completed over time as described in the Phasing and Implementation Section XII.

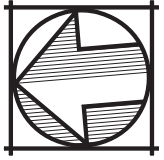
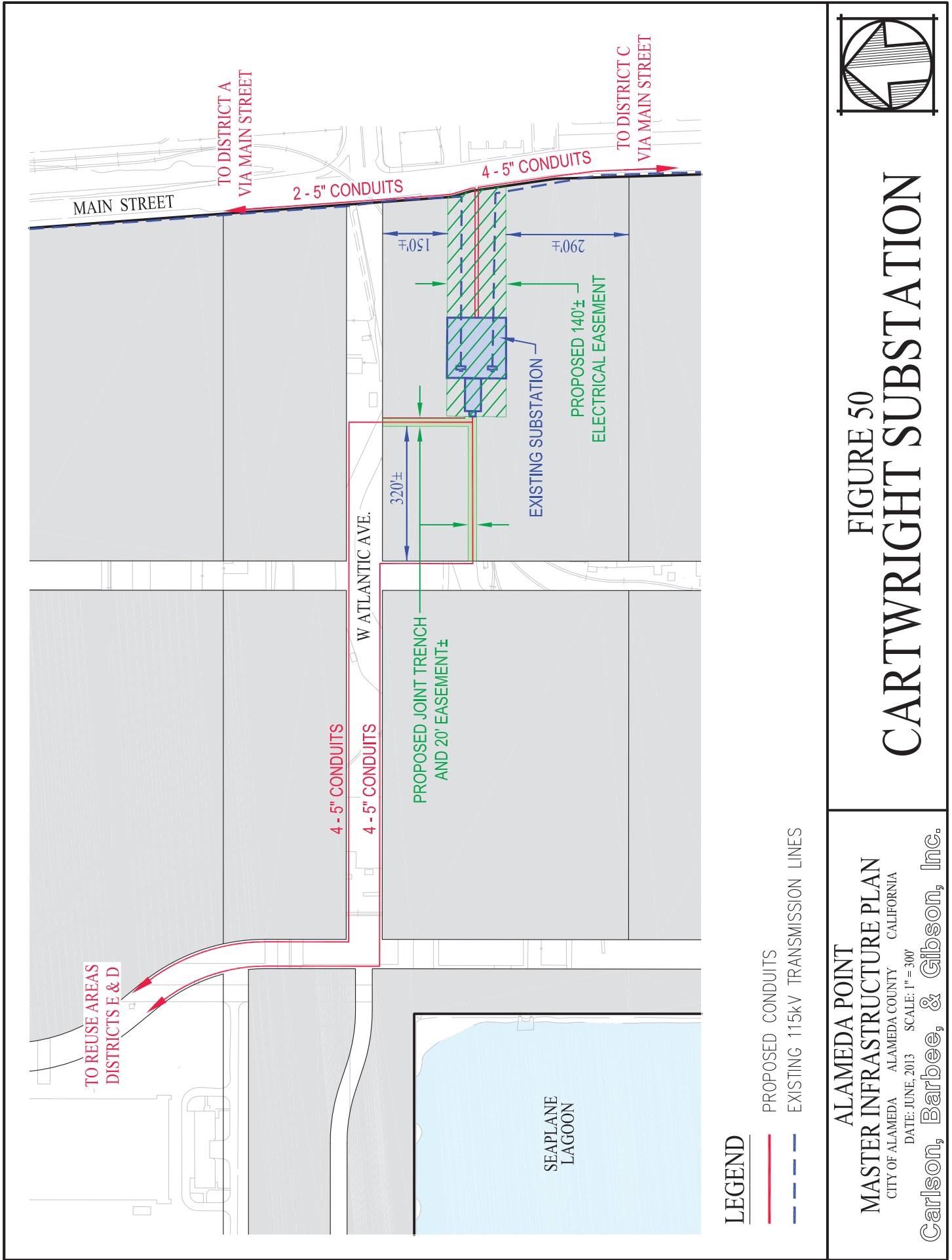

FIGURE 50 CARTWRIGHT SUBSTATION

ALAMEDA POINT
MASTER INFRASTRUCTURE PLAN
 CITY OF ALAMEDA ALAMEDA COUNTY CALIFORNIA
 DATE: JUNE, 2013 SCALE: 1" = 300'
Carlson, Barbee, & Gibson, Inc.

LEGEND

- PROPOSED CONDUITS
- - - EXISTING 115kV TRANSMISSION LINES

G:\1087-10\ACAD-10\EXHIBITS\BASE CASE ALT - FIGURES\XB_50_CARTWRIGHT SUBSTATION.DWG

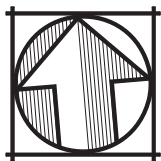
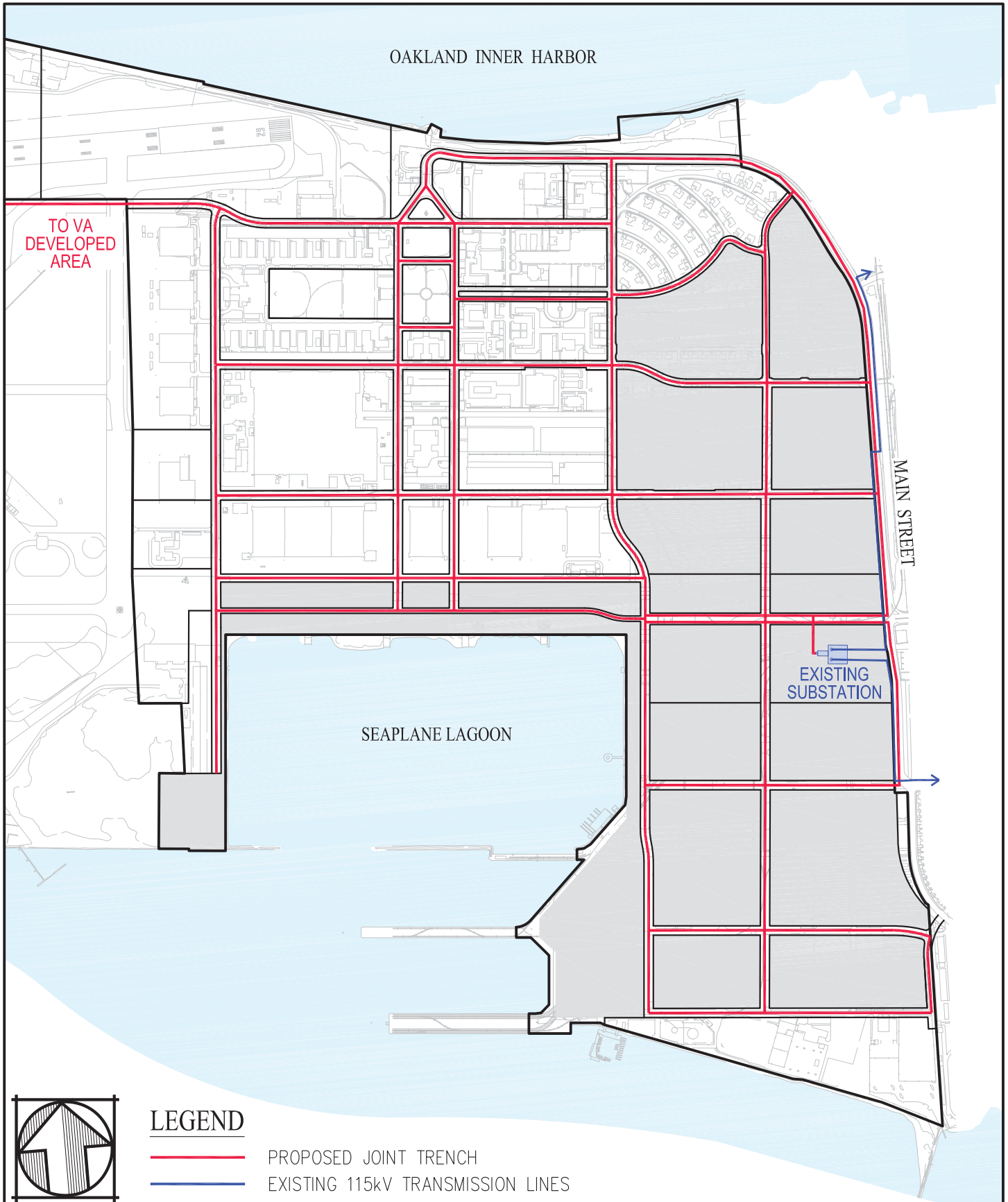

LEGEND

- PROPOSED JOINT TRENCH
- EXISTING 115kV TRANSMISSION LINES

**ALAMEDA POINT
MASTER INFRASTRUCTURE PLAN**

CITY OF ALAMEDA ALAMEDA COUNTY CALIFORNIA

DATE: JUNE, 2013 SCALE: 1" = 1,000'

Carlson, Barbee, & Gibson, Inc.

**FIGURE 51
PROPOSED ULTIMATE
JOINT TRENCH**

B. Natural Gas System

1. Existing Natural Gas System

The existing natural gas supply facilities at Alameda Point are owned and operated by PG&E. Natural gas is supplied to Alameda Point by an existing 8-inch steel main, at an operating pressure of approximately 50 psi. This 8-inch main is located along W. Atlantic Ave and continues within the Project Site heading northwest along the former rail line route. The 8-inch main terminates at an existing regulating /metering station that is located at the Ferry Point / W. Tower Ave intersection. See Figure 52 depicting the Existing Natural Gas Facilities. The existing gas distribution facilities after the regulating / metering station are owned and operated by the City of Alameda. These facilities have deteriorated and are unreliable. The gas system does not extend to all areas within Alameda Point. Additionally, the operating pressure of the existing system is so low that many existing tenants cannot utilize the natural gas service. PG&E will not accept the existing gas distribution system as it does not meet their standards. PG&E is currently evaluating a system improvements and rehabilitation prior to the redevelopment of Alameda Point.

2. Proposed Natural Gas Demand

The estimated total coincident natural gas demand for the ultimate redevelopment of Alameda Point is approximately 1,160 mcfh. See Table 12 for a summary of estimated natural gas demands associated with the build-out of the Reuse Plan. The estimated demand is based on historical natural gas utility load data for the various proposed land uses in the local climate zone.

Table 12 - Estimated Gas Demand (Buildout)

Land Use	Units	Square Footage	Acres	Estimated Demands (Mcfh)
Residential	1,425			57
Commercial		5,300,000		1,060
Retail		200,000	200,000	40
VA Development Area			75	50
Total Gas Demand:				1,207

The existing gas supply line in W. Atlantic Avenue has adequate capacity for the Project's anticipated gas demand. If a capacity upgrade to the existing gas supply line is determined to be necessary, it will be implemented by PG&E and at PG&E's expense per their tariff rules and regulations.

Atypical natural gas demands may necessitate the extension of gas distribution or transmission facilities and regulating stations. These will include any use with a natural gas demand of approximately 10 psi or higher, which is above typical distribution load and or pressure requirements

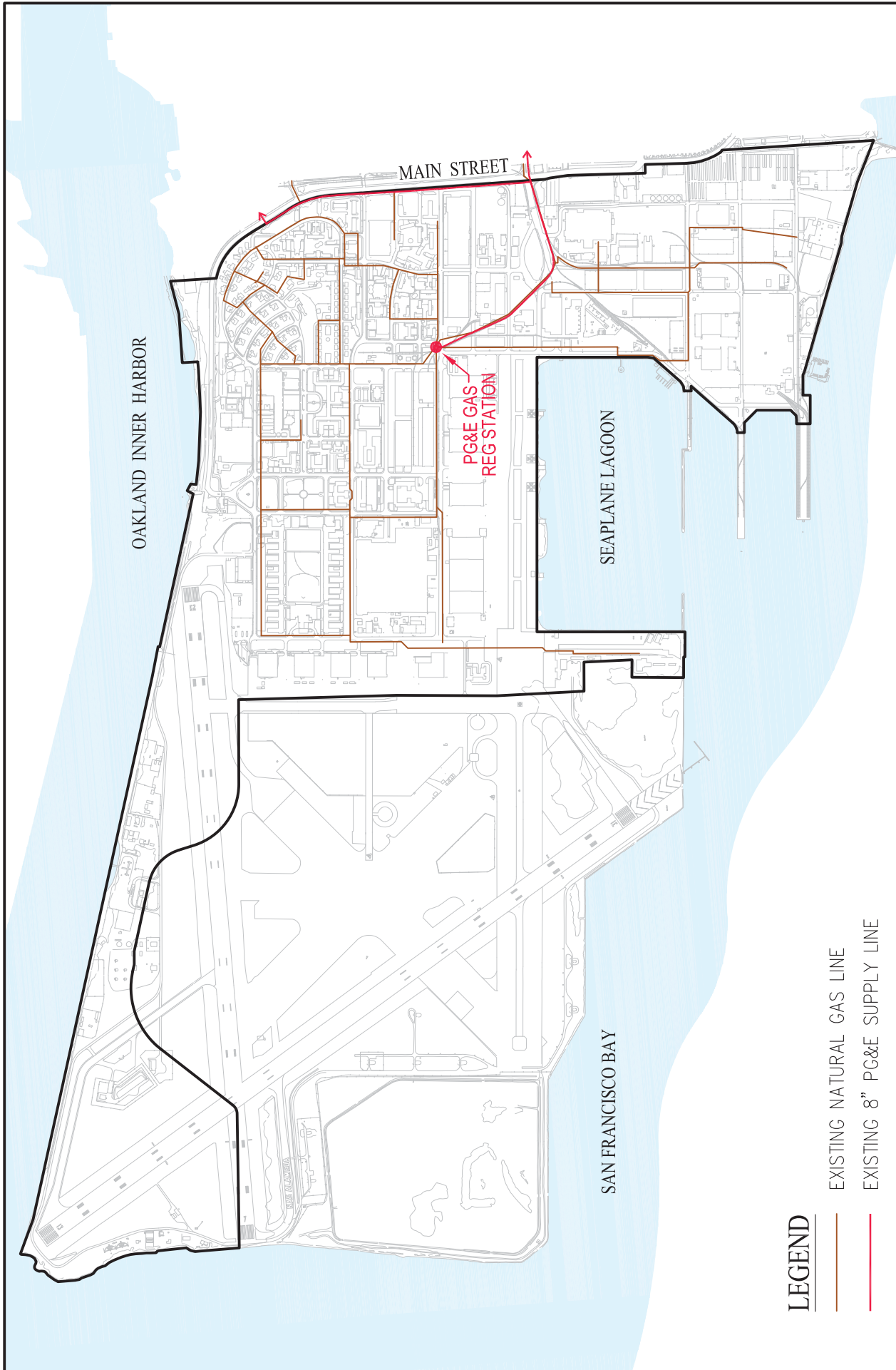

LEGEND

- EXISTING NATURAL GAS LINE
- EXISTING 8" PG&E SUPPLY LINE

**ALAMEDA POINT
MASTER INFRASTRUCTURE PLAN**
 CITY OF ALAMEDA ALAMEDA COUNTY CALIFORNIA
 DATE: JUNE, 2013 SCALE: 1" = 1,500'
Carlson, Barbee, & Gibson, Inc.

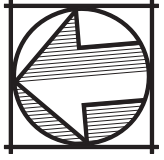

**FIGURE 52
EXISTING NATURAL GAS LINES**

3. Proposed Natural Gas System

a. Development Areas

A new natural gas distribution system will be installed throughout Alameda Point, within the Development areas. This system will connect to the existing 8-inch steel main near the W. Atlantic Ave. / Main Street intersection. The proposed gas facilities will be constructed in all backbone streets, providing reliable gas service to all Sub-Districts. The new natural gas system will replace the existing natural gas system in phases consistent with the development build-out. The proposed gas distribution system will include steel and / or plastic pipe, fittings, regulators and meters, and supervisory control equipment that are compliant with the latest PG&E standard requirements. PG&E will own and operate the new gas system. The proposed gas system will be installed in a joint utility trench as previously described.

b. Reuse Areas

The existing system within the Reuse Areas will be rehabilitated and/or replaced by PG&E. New gas distribution facilities will be extended by PG&E into backbone streets where there are not current facilities.

C. Telecommunications and Cable Television

1. Existing Telephone and Cable Television System

The existing communication utility systems at Alameda Point are owned and operated by AT&T, AMP and Comcast.

AT&T operates the existing telephone system east of the Project Site. AT&T's system includes conduits and fiber optic cables that extend across the Project Site and terminate at the eastern corner of Building 2, near the W. Midway Ave / Lexington Street intersection. The AT&T facilities terminate at this location which is AMP's "head-end" facility and the demarcation point of AMP's telephone system. This telephone system provides service to the Project Site via conduits and sub-structure facilities that emanate from the AMP "head-end".

Comcast operates the existing cable TV system within the Project Site. Comcast has extended their wires within existing available conduits within AMP's sub-structure facilities. This approach results in inadequate clearances between the electric system and the cable TV system.

The existing telecommunication systems within the Project Site are not reliable and not constructed to current standards and regulations. Additionally, the existing systems are not located in the proposed backbone street corridors.

The existing communications, telephone, fiber optic and cable TV systems operated by AT&T and Comcast to the east of the Project Site have adequate capacity to serve the proposed project.

2. Proposed Telephone and Cable Television System

a. Development Areas

New telecommunications systems, including telephone, cable TV and fiber optics will be installed within the Development Areas. These systems will connect to the existing systems east of the Project Site, near Main Street. The proposed telecommunication facilities will be constructed in all backbone streets, within both the Development and Reuse areas, providing reliable service to all Sub-Districts. The new telecommunication system will replace the existing systems in phases consistent with the development build-out. The proposed system will include extensions of conduits, substructure facilities, and supervisory control equipment that are compliant with the latest AT&T and Comcast standard requirements. The proposed telecommunications systems will be installed in a joint utility trench as previously described.

b. Reuse Areas

The Reuse Areas within Alameda Point initially will continue to utilize the existing telecommunication system through an enhanced maintenance program. This program will rehabilitate the existing system to address deficiencies. Each proposed development within the Reuse Areas will be responsible for investigating and documenting the condition of the existing facilities directly adjacent to that specific site. Any deficiencies identified shall be address at the time of that development.

Ultimately, the telecommunication system within the Reuse Areas will be replaced. The proposed system will be similar to the system proposed within the Development Areas, constructed in a joint utility trench. The replacement of the telecommunication system within the Reuse Areas will be completed over time as described in the Phasing and Implementation Section XII.

D. Street Light System

1. Existing Street Light System

The existing street lighting system at Alameda Point is owned and operated by AMP. The existing street lighting is operable but does not meet the current utility standards or lighting requirements.

2. Proposed Street Lighting System

A new street lighting system will be installed within all backbone streets of the Development Areas. The street light system within the Reuse Areas will be replaced over time as described in the Phasing and Implementation Section XII. Photometric requirements and placement of lighting units shall comply with AMP's standards. The lighting criteria shall also be compliant with the latest Illuminating Engineering Society (IES) standards. The lighting units shall utilize energy efficient luminaires, such as light emitting-diode (LED) type luminaires.

The proposed lighting system will be designed in accordance and adhere to the lighting mitigation measures defined in the Biological Opinion issued by the United States Fish and Wildlife Service for Alameda Point and a Memorandum of Agreement with the VA regarding lighting mitigation measures.

XI. SUSTAINABILITY CONSIDERATIONS

The MIP establishes a practical yet comprehensive approach to integrating sustainable considerations with the backbone infrastructure proposed for Alameda Point. The key sustainable elements of the backbone infrastructure include creating a seismically stable site that can adapt to the potential impacts of climate change, utilize existing utility capacities available at the Project Site, harness the green infrastructure of the utility agencies serving the Project Site, conserve and restore natural resources, promote the well-being of the community through numerous active parks and open space areas and allow for future green infrastructure enhancements to be implemented within future in-tract / on-site development areas.

When constructing NAS Alameda, the Navy designed the Project Site and associated infrastructure for a limited design and service time frame. Similar to many of the historic infrastructure systems in the Bay Area, the existing infrastructure, including flood and seismic protection measures, at Alameda Point has a limited life and requires eventual replacement or enhancement. The proposed site improvements presented in the MIP rehabilitate and replace the existing infrastructure to establish reliable and protected systems. The proposed improvements will provide long term protection and future adaptability from potential rising sea levels associated with climate change. Additionally, corrective geotechnical measures will be implemented to address liquefiable soils and shoreline instability. The proposed improvements at Alameda Point transform the Project Site into a long term, flood and seismically safe community with dependable systems able to serve and protect many generations.

The historic uses at NAS Alameda required large infrastructure demands. Therefore, the Project Site offers a unique setting with large existing and available utility capacities. These include wastewater treatment by EBMUD, potable water supply by EBMUD and electrical supply from AMP. Both EBMUD and AMP have exceptional sustainable and environmentally conscious systems. As examples, EBMUD uses nearly 90% less energy to delivery water to its service area than the average water provider in California. Also, EBMUD became the first utility district in North America to operate a wastewater treatment plant that generated more renewable energy at the plant than is needed to run the facility. Similarly, AMP maintains a power portfolio that typically is comprised of 80% of renewable and clean energy sources. The backbone infrastructure at Alameda Point is proposed to continue to connect to these highly sustainable sources of infrastructure.

Other sustainable components of the backbone infrastructure include:

- Demolish and abate unusable and decrepit structures.
- Rehabilitate and re-use of historic and other usable structures.
- Re-use and recycling of on-site materials.
- Implement sea level rise adaption plan that includes monitoring and methods to provide long term protection and adapt flood protection improvements to varying amounts of sea level rise.
- Construct a new grid of “complete streets” supporting a broad range of transportation choices.
- Construct a comprehensive network of pedestrian and bicycle routes including components of the Bay Trail and the Cross Alameda Trail.
- Construct walkable streets with controlled intersections, bulb-outs and high-visible crosswalks.
- New and improved transit systems such as a shuttle/bus rapid transit, and improved ferry terminal.
- Implement Low Impact Development (LID) principles for the management and treatment of stormwater runoff with bio-swales, bio-filtration areas and other technologies to clean stormwater runoff prior to outfall to the Bay or Estuary.
- Install a new wastewater collection system reducing the amount of groundwater infiltration and wet weather flows.

The future on-site / in-tract developments and the associated construction of structures will build upon the foundation established by the backbone infrastructure and further improve the sustainability of Alameda Point. New construction at Alameda Point will be designed to conserve resources and minimize demands by utilizing water reducing fixtures and energy efficient appliances within proposed structures. Additionally, a Transportation Demand Management Plan (TDM) being developed by the City will focus on ways to reduce single occupancy vehicles and encourage the use of other modes of transportation. Examples of other sustainability features of future development are likely to include:

- Offering of transit passes to residents and employees to promote and increase the use of transit for residents and employees living and working at Alameda Point, including shuttle services.
- Provide opportunities for car and bike sharing and other TDM programs.
- Implement rain water harvesting systems that reuse stormwater as a supplements supply of water for landscaping and other approved uses. These systems could include a rain barrel or similar type of rain water collection and storage system.
- Incorporate non-polluting renewable energy generation sources, such as solar, geothermal and / or biomass.

As sustainable technologies advance and evolve, future green and sustainable enhancements within the development sites at Alameda Point will likely become more feasible.

XII. PHASING AND IMPLEMENTATION

A. Principles of Phasing and Implementation

The backbone infrastructure improvements required for the redevelopment of Alameda Point will be phased to match the development phases as closely as possible. The required improvements for each phase will include demolition, flood protection, corrective geotechnical measures, site grading, utilities, streets and transit improvements. Each phase will construct the portion of infrastructure required to support the proposed uses and surrounding existing uses and to maintain financial feasibility of the project. In some cases, initial phases of development will construct components of the backbone infrastructure that also benefit subsequent phases or conversely later phases may construct infrastructure components that benefit prior phases.

The following are principles of phasing and implementation for each component of the backbone infrastructure:

1. Demolition

The demolition of existing utilities and streets will be completed in phases to match the development phases.

2. Corrective Geotechnical Measures

The northern shoreline stabilization should be completed as soon as possible in order to eliminate the existing risk of losing critical infrastructure along this corridor. At minimum, the northern shoreline stabilization will be completed prior to or concurrently with the flood protection measures along this shoreline are constructed.

The other corrective geotechnical measures, liquefaction remediation and Young Bay Mud compression, will be completed in phases to match the development phases.

3. Flood Protection and Site Grading

Within the Development Areas, the flood protection measures and proposed site grading will be phased to match the development phases. The flood protection measures required to protect each development phase will be implemented with that phase. The initial development phases will likely be required to construct flood protection measures that will benefit the subsequent phases such as stormwater outfalls, basins or pump stations.

Within the Reuse Areas, the flood protection measures will be constructed as soon as adequate funds are available, as discussed in Section XII.B, to construct the required improvements. Until then, flood insurance policies shall be obtained by owners and tenants of existing low lying structures.

4. Street System

Within the Development Areas, the construction of new on-site street improvements will be phased to match the development phases. The required timing of the off-site street improvements and implementation of the transit improvements will be outlined in the mitigation measures in the Alameda Point EIR.

Within the Reuse Areas, the rehabilitation of the existing on-site street improvements will be constructed through an enhanced maintenance program as funds permit through a fee program or grants. These streets will become part of the City's citywide pavement rehabilitation program and will be improved over time on a priority basis through this program. Additional improvements will be completed as adequate funds are generated through the APIFP or available grants have been obtained.

5. Wastewater System

Within the Development Areas, the construction of new on-site wastewater collection system will be phased to match the development phases. The initial development subphases will be required to construct the new wastewater facilities within that development area. These initial subphases may analyze the feasibility of utilizing the existing wastewater system from that specific development to Pump Station 1. The existing system shall be inspected and televised to determine if interim rehabilitation improvements are necessary. Eventually, when there is an adequate amount of development, such that the capacity of the existing system is exceeded or as determined by the Public Works Director, the ultimate system from the development area to Pump Station 1 will be required to be installed.

Within the Reuse Areas, the replacement of the existing wastewater system will be incrementally completed over time as funds permit through a fee program. An enhanced maintenance program will be established to implement the interim rehabilitation of the existing facilities and the eventual replacement. Interim rehabilitation improvements will be implemented by individual development projects within the Reuse Areas. These improvements will likely include cleaning and lining of existing pipelines and manholes to address infiltration and inflow.

The ultimate replacement of the existing facilities will be completed incrementally over time as adequate funds are available, through a fee program or grants as discussed in Section XII.B. The incremental replacements should start at the downstream portion of the system.

All new adaptive reuse projects within the Reuse Areas will replace the wastewater lateral and on-site pipelines serving that site, consistent with the City of Alameda's Private Sewer Lateral Replacement Ordinance, at the time of that project.

6. Stormwater System

Within the Development Areas, the construction of new on-site stormwater collection system will be phased to match the development phases. The initial development phases will be required to construct the new downstream stormwater facilities ensuring adequate discharge to surrounding waters and flood protection. These downstream improvements will include pipeline extensions to the shoreline, multi-purpose basins, pump stations and outlets, which will benefit the subsequent phases within that watershed.

Within the Reuse Areas, the replacement of the existing stormwater system will be incrementally completed over time as funds permit through a fee program. An enhanced maintenance program will be established to implement the interim rehabilitation of the existing facilities. The initial interim improvements to be prioritized for the Reuse Areas include replacement of tide valves at the existing stormwater outfalls. These initial improvements should be prioritized as they will eliminate the tidal waters backing up through the existing system and inundating low lying areas in a high tide event. The low lying structures will require flood insurance throughout this enhanced maintenance program period until the ultimate flood protection measures have been completed.

Additional interim rehabilitation improvements to the existing system will be implemented with available funds through a fee program, as discussed in Section XII.B. The additional rehabilitation improvements include cleaning, lining and replacement of existing pipelines and manholes.

The ultimate replacement of the existing facilities and the implementation of the ultimate flood protection measures will be completed over time as adequate funds are available through a fee program or grants, as discussed in Section XII.B.

7. Potable Water System

Within the Development Areas, the construction of new on-site potable water distribution system will be phased to match the development phases. The new potable water system will be required to connect to and extend from the existing reliable EBMUD pipelines in Main Street.

Within the Reuse Areas, the replacement of the existing potable water system will be incrementally completed over time. The replacement of the exterior water line loop throughout the Reuse Areas shall be prioritized. This loop includes the pipelines within W. Redline Ave, Monarch Street, W. Tower Ave and Pan Am Street.

The ultimate replacement of the existing facilities will be completed over time as adequate funds are available through a fee program or grants, as discussed in Section XII.B. The system replacements shall extend east to west, from the new reliable facilities within the Development Areas to the Reuse Areas.

All new adaptive reuse projects within the Reuse Areas will replace the potable and fire water lateral serving that site.

8. Recycled Water System

Within both the Development and Reuse Areas, the construction of new on-site recycled water distribution system will be phased to match the development phases.

9. Dry Utility System

Within the Development Areas, the construction of new on-site dry utility systems will be phased to match the development phases. The new electrical system will be required to connect to and extend from the existing Cartwright Substation. The new natural gas and telecommunications systems will be required to connect to the reliable systems in Main Street. The dry utilities will be constructed in a joint utility trench.

Within the Reuse Areas, the replacement of the electrical and telecommunication systems will be completed over time as funds permit through a fee program. The system replacements will be completed as adequate funds are available through a fee program or grants, as discussed in Section XII.B. PG&E will rehabilitate and extend the existing natural gas system as necessary to serve the Reuse Areas with reliable facilities.

10. Service to Existing Lessees

Temporary reconfiguration of utilities and streets that are within a development phase and serve existing surrounding tenants will be required to ensure there is no disruption of service to the tenants. Temporary connections to the new systems will be required to maintain service to existing land uses. Any connection to unreliable existing infrastructure systems will need to provide the appropriate measures to protect the integrity of the new systems.

B. Funding and Financing Approach

The implementation of the backbone infrastructure will require constant coordination. Certain areas may have multiple contiguous development areas that proceed concurrently, while others may develop in smaller phases that are not contiguous. There are many infrastructure improvements that have shared benefit to multiple development areas. It is anticipated that an Alameda Point Infrastructure Fee Program (APIFP) will be established to coordinate the funding and repayments associated with site-wide improvements. The APIFP will collect fees from both Development and Reuse Areas to generate funds to construct improvements with site-wide or multiple property benefit. The APIFP will also provide a mechanism for developments that construct these types of improvements to capture repayments from other future phases of development.

Other alternatives of infrastructure implementation and funding may also be employed at Alameda Point. These include seeking of infrastructure grants or tax measures. Another alternative is to create “packages” of infrastructure with site-wide benefit that would be assigned to be constructed by certain development areas. The infrastructure packages would include all improvements necessary to support that specific development area as well as additional improvements with benefit to surrounding areas.

Specific to the Reuse Areas, the APIFP and these other potential funding sources will be the mechanism to accumulate adequate funds to implement the incremental replacement of the existing infrastructure. As funds are generated, the following improvements within the Reuse Areas and with site-wide benefit should be prioritized, in no specific order:

- Northern Shoreline Stabilization
- Perimeter Flood Protection Measures
- Wastewater Pipeline Replacements
- Exterior Potable Waterline Loop

Additionally, a Geologic Hazard Abatement District (GHAD) may be established at Alameda Point to serve as the mechanism to monitor, maintain and implement the adaptive flood protection measures addressing future sea level rise.

C. Phase 1 - Scenario 1

Phase 1 Scenario 1 contemplates the Enterprise Sub-District as the first phase at Alameda Point. See Figure 53 depicting this Phase 1 scenario. The following are the required backbone improvements for this scenario:

1. Demolition

- Construct temporary re-routed utility services to the active tenants and uses on the piers (MARAD) and recreation uses in Enterprise Park.
- Construct temporary access streets to the active tenants and uses on the piers (MARAD) and recreation uses in Enterprise Park.
- Demolish and recycle existing structures, utilities and streets within Phase 1 areas.

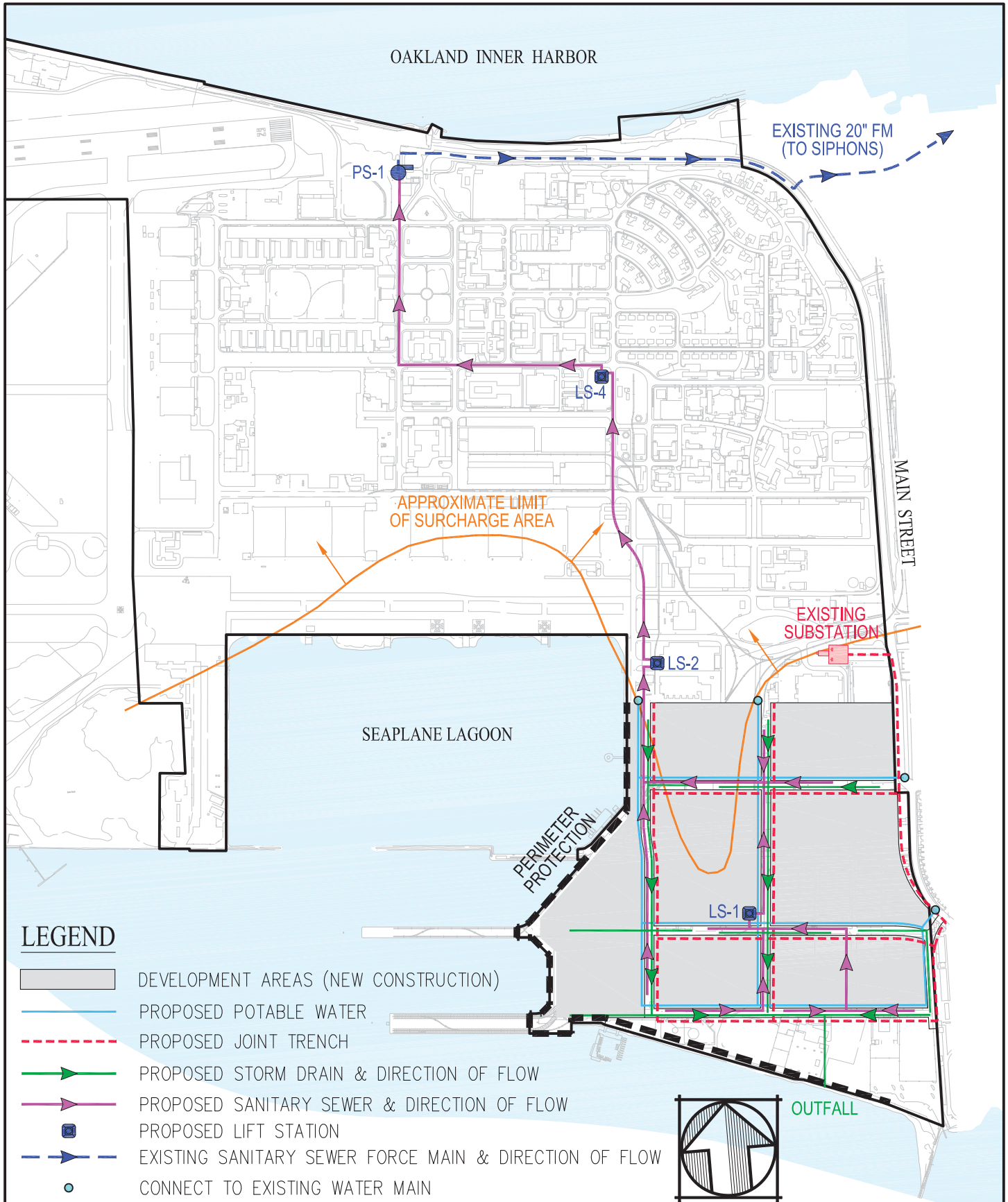

LEGEND

- DEVELOPMENT AREAS (NEW CONSTRUCTION)
- PROPOSED POTABLE WATER
- PROPOSED JOINT TRENCH
- PROPOSED STORM DRAIN & DIRECTION OF FLOW
- PROPOSED SANITARY SEWER & DIRECTION OF FLOW
- PROPOSED LIFT STATION
- EXISTING SANITARY SEWER FORCE MAIN & DIRECTION OF FLOW
- CONNECT TO EXISTING WATER MAIN

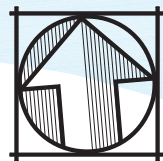

OUTFALL

**ALAMEDA POINT
MASTER INFRASTRUCTURE PLAN**
CITY OF ALAMEDA ALAMEDA COUNTY CALIFORNIA
DATE: JUNE, 2013 SCALE: 1" = 1,000'
Carlson, Barbee, & Gibson, Inc.

**FIGURE 53
PHASING PLAN
SCENARIO 1**

2. Flood Protection and Site Grading

- Implement the required corrective geotechnical measures, anticipated measures include:
 - DDC for liquefiable soils across Phase 1
 - Implement a surcharge operation for compressible soils within the portion of Phase 1 underlain by Young Bay Mud
- Elevate the shoreline facilities as required to achieve the minimum elevations outlined in the site grading design criteria.
- Elevate the inland areas to achieve the minimum elevations outlined in the site grading design criteria.

3. Street System

- Construct new on-site streets within Phase 1 areas
- Construct off-site street improvements and transit system improvements as identified in the mitigation measures in the Alameda Point EIR.
- Construct temporary transitions to existing streets within surrounding areas.

4. Wastewater System

- Construct new on-site wastewater collection system of pipelines and lift stations within Phase 1 areas
- Construct new wastewater collection system through future phases to connect to Pump Station 1.
- Construct temporary connections to the existing on-site wastewater collection system within surrounding areas.

5. Stormwater System

- Construct new on-site stormwater collection system within Phase 1 areas
- Construct new pipeline and outfall to the southern shoreline
- Construct water quality improvements within proposed streets and development blocks.
- Construct temporary connections to the existing on-site stormwater collection system within surrounding areas.

6. Potable Water System

- Construct new on-site potable water distribution system within Phase 1 areas
- Connect to the existing EBMUD pipelines within Main Street.
- Construct temporary connections with appropriate backflow measures to the existing on-site potable water system within surrounding areas.

7. Recycled Water System

- Construct new on-site recycled water distribution system within Phase 1 areas

8. Dry Utility System

- Construct new dry utility system in a joint trench within Phase 1 areas
- Construct new electrical main lines in Main Street to connect to the Cartwright Substation.
- Connect to the existing natural gas and telecommunication facilities within Main Street.
- Construct temporary connections to the existing dry utility systems within surrounding areas.

9. APIFP

- Contribute to the APIFP for this Development Area's fair share of project-wide improvements and community benefits.
- Document and seek reimbursements from future phases for any shared improvements constructed as part of Phase 1.

D. Phase 1 - Scenario 2

Phase 1 Scenario 2 contemplates the Main Street Neighborhood Sub-District as the first phase at Alameda Point. This Sub-District includes areas within both the Development and Reuse Areas. See Figure 54 depicting this Phase 1 scenario. The following are the required backbone improvements for this scenario:

1. Demolition

- Assist and support the coordination of the relocation of the Alameda Point Collaborative supportive housing to a new site.
- Construct temporary re-routed utility services to the active tenants and uses within the Adaptive Reuse and Waterfront Town Center Sub-Districts.
- Construct temporary access streets to the active tenants and uses within the Adaptive Reuse and Waterfront Town Center Sub-Districts.
- Demolish and recycle existing structures, utilities and streets within Phase 1 areas.

2. Flood Protection and Site Grading

- Implement the required corrective geotechnical measures, anticipated measures include:
 - DDC for liquefiable soils across Phase 1
 - Implement a surcharge operation for compressible soils across Phase 1
- Elevate the shoreline facilities as required to achieve the minimum elevations outlined in the site grading design criteria to elevation 7.1 along the northern shoreline and 6.1 along the Seaplane Lagoon.
- Elevate the inland areas to achieve the minimum elevations outlined in the site grading design criteria, to elevation 5.1.

3. Street System

- Construct new on-site streets within Phase 1 Development areas
- Construct off-site street improvements and transit system improvements as identified in the Alameda Point EIR.
- Construct temporary transitions to existing streets within surrounding areas.

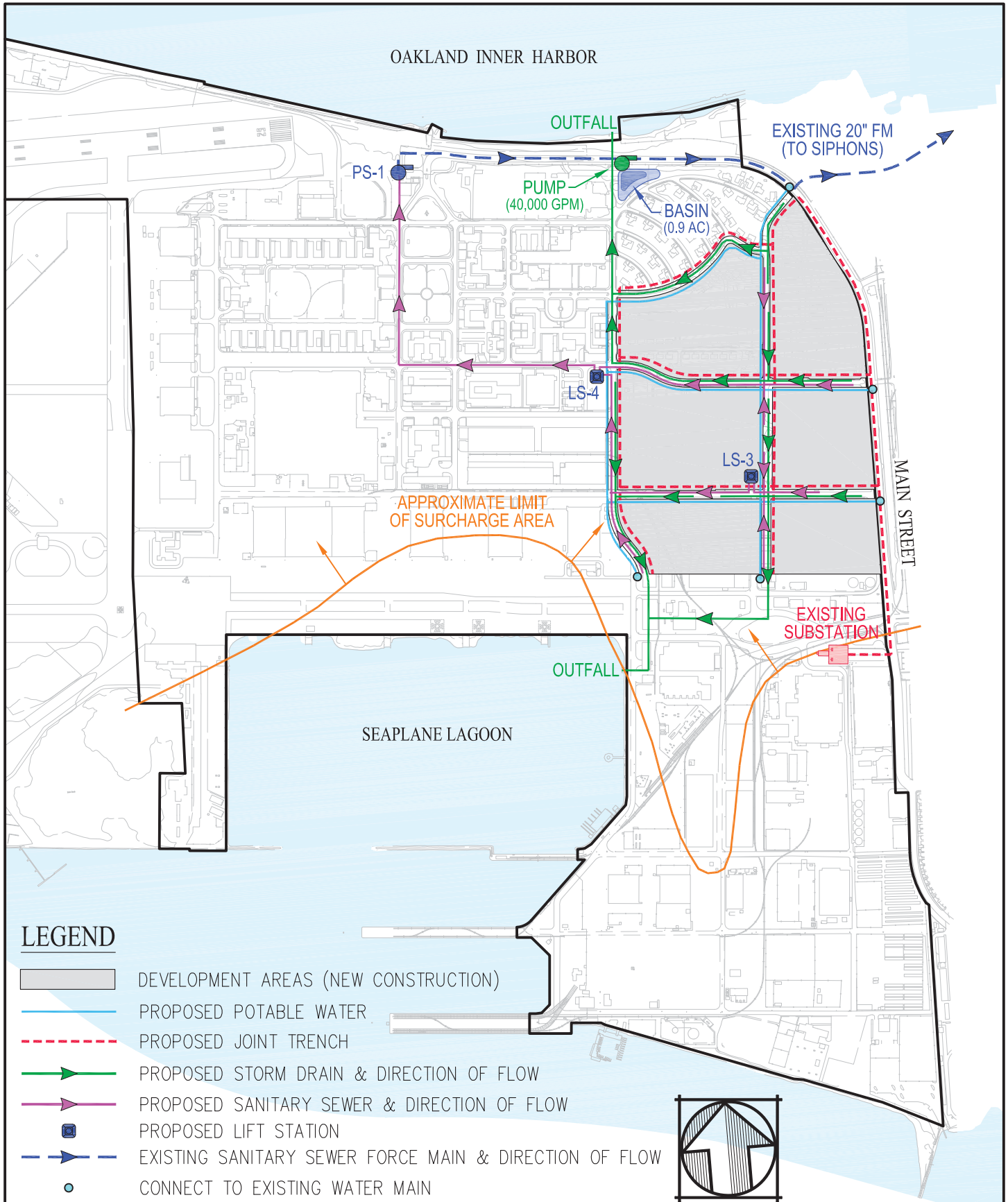

LEGEND

- DEVELOPMENT AREAS (NEW CONSTRUCTION)
- PROPOSED POTABLE WATER
- PROPOSED JOINT TRENCH
- PROPOSED STORM DRAIN & DIRECTION OF FLOW
- PROPOSED SANITARY SEWER & DIRECTION OF FLOW
- PROPOSED LIFT STATION
- EXISTING SANITARY SEWER FORCE MAIN & DIRECTION OF FLOW
- CONNECT TO EXISTING WATER MAIN

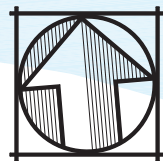

**ALAMEDA POINT
MASTER INFRASTRUCTURE PLAN**
CITY OF ALAMEDA ALAMEDA COUNTY CALIFORNIA
DATE: JUNE, 2013 SCALE: 1" = 1,000'
Carlson, Barbee, & Gibson, Inc.

**FIGURE 54
PHASING PLAN
SCENARIO 2**

4. Wastewater System

- Construct new on-site wastewater collection system of pipelines and lift stations within Phase 1 Development areas
- Construct new wastewater collection system through future phases to connect to Pump Station 1.
- Construct new wastewater laterals within Phase 1 Reuse Areas (Big Whites)
- Construct temporary connections to the existing on-site wastewater collection system within surrounding areas.

5. Stormwater System

- Construct new on-site stormwater collection system within Phase 1 Development areas
- Construct new pipelines, multi-purpose basins, pump station and outfalls to the northern and Seaplane Lagoon shorelines
- Construct water quality improvements within proposed streets and development blocks.
- Construct temporary connections to the existing on-site stormwater collection system within surrounding areas.

6. Potable Water System

- Construct new on-site potable water distribution system within Phase 1 Development and Reuse areas
- Connect to the existing EBMUD pipelines within Main Street.
- Construct temporary connections with appropriate backflow measures to the existing on-site potable water system within surrounding areas.

7. Recycled Water System

- Construct new on-site recycled water distribution system within Phase 1 areas

8. Dry Utility System

- Construct new dry utility system in a joint trench within Phase 1 Development and Reuse areas
- Construct new electrical main lines in Main Street and W. Atlantic Ave to connect to the Cartwright Substation.
- Connect to the existing natural gas and telecommunication facilities within Main Street.
- Construct temporary connections to the existing dry utility systems within surrounding areas.

9. APIFP

- Contribute to the APIFP for this Development Area's fair share of project-wide improvements and community benefits.
- Document and seek reimbursements from future phases for any shared improvements constructed as part of Phase 1.

E. Phase 1 - Scenario 3

Phase 1 Scenario 3 contemplates the adaptive reuse of the Bachelors Enlisted Quarters in the Adaptive Reuse Sub-District as the first phase at Alameda Point. This development block is solely within the Reuse Areas. See Figure 55 depicting this Phase 1 scenario. The following are the required backbone improvements for this scenario:

1. Flood Protection and Site Grading

- Contribute to the APIFP for this site's fair share amount of the required flood protection measures for the Reuse Areas.

2. Street System

- Contribute to the APIFP for this site's fair share amount of the rehabilitation of the existing streets within the Reuse Areas.

3. Wastewater System

- Investigate the existing pipelines collecting and conveying the wastewater from this site.
- Construct necessary rehabilitating improvements to the existing system to address any deficiencies identified.
- Construct new wastewater laterals to structures within Phase 1
- Contribute to the APIFP for this site's fair share amount of the replacement of the wastewater system within the Reuse Areas.

4. Stormwater System

- Contribute to the APIFP for this site's fair share amount of the new downstream stormwater facilities, pipelines, multi-purpose basin, pump station and outfall to the northern shoreline.
- Contribute to the APIFP for this site's fair share amount of the replacement of the stormwater collection system within the Reuse Areas.
- Construct new stormwater and water quality facilities within the development parcel.

5. Potable Water System

- Contribute to the APIFP for this site's fair share amount of the replacement of the potable water distribution system within the Reuse Areas.
- Construct new potable and fire water services to the development parcel.

6. Dry Utility System



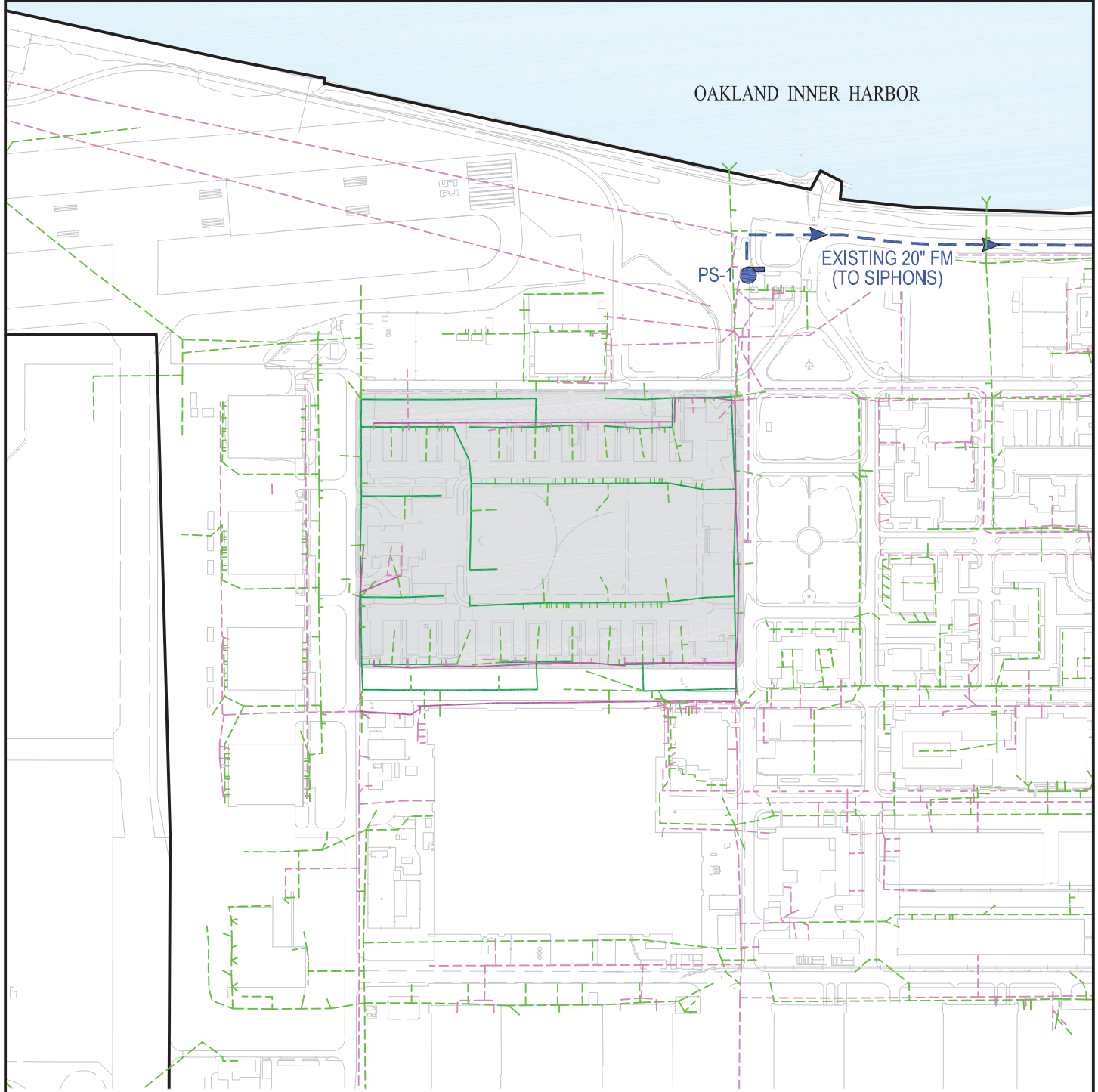

- Contribute to the APIFP for this site's fair share amount of the replacement of the electrical and telecommunication systems within the Reuse Areas.
- Construct new electrical and telecommunication services to the development parcel.

7. APIFP

- Contribute to the APIFP for this site's fair share amount of project-wide improvements and community benefits.



LEGEND

-  REUSE AREA
-  PROPOSED STORM DRAIN (TRUNK MAIN RETROFIT)
-  PROPOSED SANITARY SEWER (TRUNK MAIN RETROFIT)
-  EXISTING STORM DRAIN
-  EXISTING SANITARY SEWER

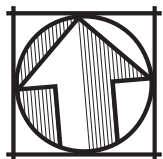

**ALAMEDA POINT
MASTER INFRASTRUCTURE PLAN**

CITY OF ALAMEDA ALAMEDA COUNTY CALIFORNIA

DATE: JUNE, 2013 SCALE: 1" = 500'

Carlson, Barbee, & Gibson, Inc.

**FIGURE 55
PHASING PLAN
SCENARIO 3**

F. Sub-Phases

The sub-phases that comprise each of the Phase 1 scenarios outlined above will implement the backbone improvements generally consistent with the principles outlined above. Each sub-phase within the Development Areas will construct the new backbone infrastructure within and adjacent to that specific sub-phase. The only utility system within Development Areas that may be deferred is the installation of new wastewater facilities extending to Pump Station 1. The initial phases may analyze the feasibility of utilizing the existing wastewater system from that specific development to Pump Station 1. The existing system shall be inspected and televised to determine if interim rehabilitation improvements are necessary. Eventually, when there is an adequate amount of development, such that the capacity of the existing system is exceeded or as determined by the Public Works Director, the ultimate system from the development area to Pump Station 1 will be required to be installed. See Figure 56 and Figure 57 depicting the conceptual infrastructure to be installed with the initial sub-phases (1A) for Scenario 1 and 2.

The infrastructure improvements within the Reuse Areas will be implemented as funds permit through a fee program or grants.

G. Permitting

The following are the agencies that have oversight to the backbone infrastructure at Alameda Point and will issue permits for certain components of infrastructure:

1. City of Alameda

Any proposed street, storm drainage, water quality and sanitary sewer system improvements will be required to be reviewed and approved by the City of Alameda.

2. Alameda Municipal Power

Any proposed improvements to the electrical, telephone or joint trench system will be required to be reviewed and approved by Alameda Municipal Power.

3. EBMUD

Any proposed improvements to the EBMUD owned and maintained sanitary sewer transmission facilities will be required to be reviewed and approved by EBMUD. This would include any proposed improvement to the existing Pump Station 1 near the Main Gate and/or the 20-inch force main.

Any proposed improvements to the potable or recycled water systems will be required to be designed, reviewed and approved by EBMUD.

4. FEMA

Initially, a Flood Insurance Study will be prepared and processed with FEMA to evaluate the existing conditions at Alameda Point and define the flood zones within the Project Site. The study shall be conducted for the entire Project Site. The FIRM maps (panels) for the City of Alameda will be revised through this process to include Alameda Point.

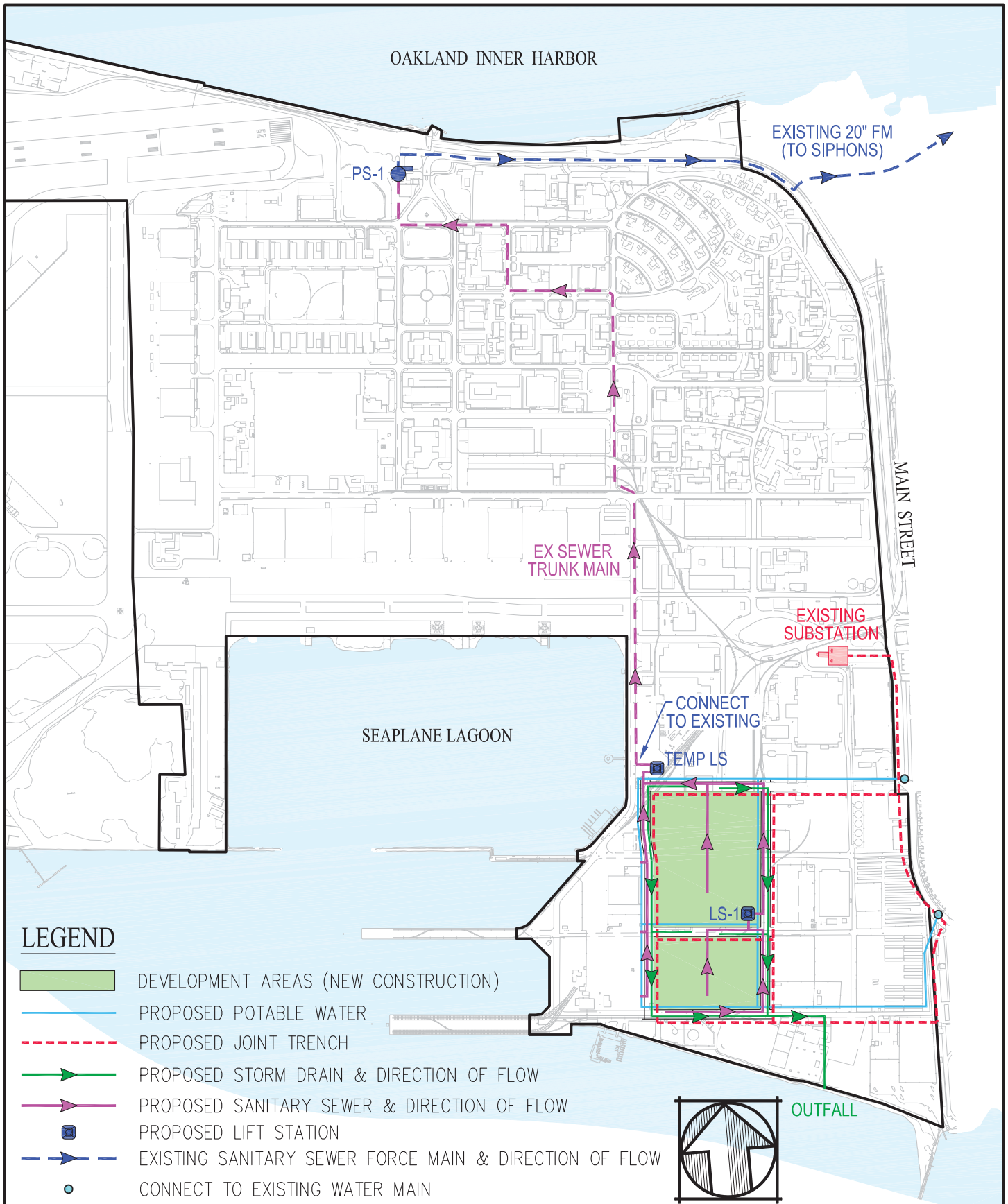

LEGEND

- DEVELOPMENT AREAS (NEW CONSTRUCTION)
- PROPOSED POTABLE WATER
- PROPOSED JOINT TRENCH
- PROPOSED STORM DRAIN & DIRECTION OF FLOW
- PROPOSED SANITARY SEWER & DIRECTION OF FLOW
- PROPOSED LIFT STATION
- EXISTING SANITARY SEWER FORCE MAIN & DIRECTION OF FLOW
- CONNECT TO EXISTING WATER MAIN

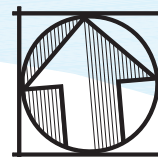

OUTFALL

**ALAMEDA POINT
MASTER INFRASTRUCTURE PLAN**

CITY OF ALAMEDA ALAMEDA COUNTY CALIFORNIA

DATE: JUNE, 2013 SCALE: 1" = 1,000'

Carlson, Barbee, & Gibson, Inc.

**FIGURE 56
PHASE 1A
"SOUTH"**

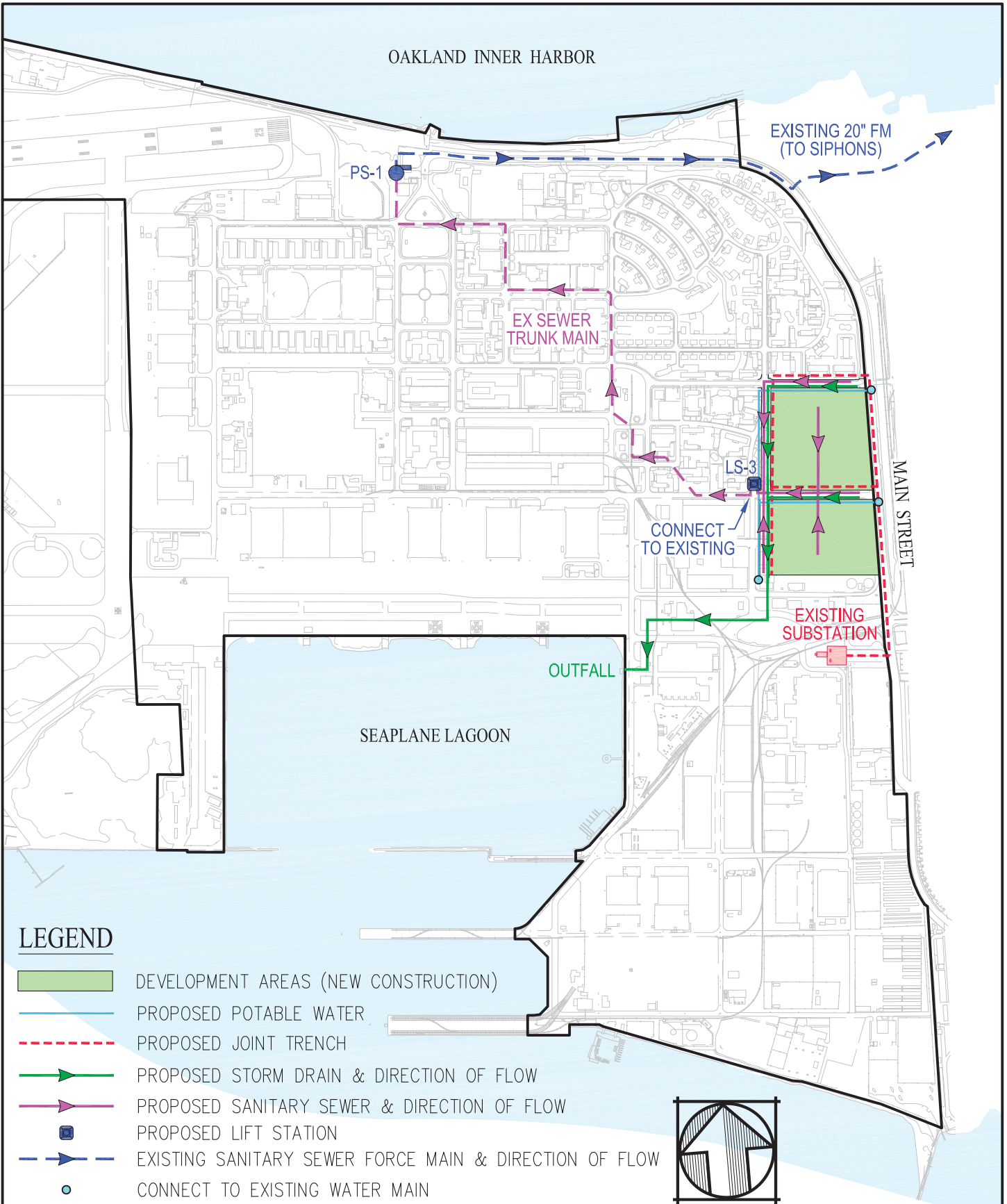

LEGEND

- DEVELOPMENT AREAS (NEW CONSTRUCTION)
- PROPOSED POTABLE WATER
- PROPOSED JOINT TRENCH
- PROPOSED STORM DRAIN & DIRECTION OF FLOW
- PROPOSED SANITARY SEWER & DIRECTION OF FLOW
- PROPOSED LIFT STATION
- EXISTING SANITARY SEWER FORCE MAIN & DIRECTION OF FLOW
- CONNECT TO EXISTING WATER MAIN

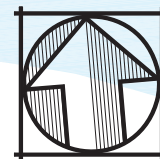

**ALAMEDA POINT
MASTER INFRASTRUCTURE PLAN**

CITY OF ALAMEDA ALAMEDA COUNTY CALIFORNIA

DATE: JUNE, 2013 SCALE: 1" = 1,000'

Carlson, Barbee, & Gibson, Inc.

**FIGURE 57
PHASE 1A
"NORTH"**

At the time that design of flood protection measures is being completed, a Conditional Letter of Map Revision (CLOMR) shall be processed and approved by FEMA. The CLOMR will demonstrate FEMA's concurrence that design of the flood protection measures will remove the proposed development areas from the flood zones. Once the flood protection measures have been constructed, a field survey can be completed to document the as-built elevations of these facilities. This information will be used to process a final Letter of Map Revisions (LOMR). Once the LOMR is approved by FEMA, the FIRM panel will be revised to depict the constructed flood protection measures and remove the protected areas from the floodplain. The CLOMR and LOMR can be prepared and processed in phases with the development phasing.

5. Regional Water Quality Control Board (RWQCB)

A water quality certification, Section 401, will be required from the Regional Water Quality Board (RWQCB) for activities within wetlands or below the ordinarily high water line. This certification will be required for the outfall construction at Alameda Point. The project need to demonstrate compliance with the water quality regulations of the MRP for the storm runoff from the Project Site. As described above, the implementation of the water quality improvements will be phased in the Development Areas and incremental in the Reuse Areas. Accordingly, it is anticipated that a site-wide water quality certification will be pursued for all outfalls and waste discharge requirements will be established for the site outlining how the water quality compliance will be achieved over time.

6. Army Corp of Engineers

Any improvement within the waters of the United States shall require a permit, Section 404, from Army Corp of Engineers. This will include construction of the stormwater outfalls or any shoreline flood protection measures that require construction below the ordinary high water line. Additional consultations from other federal agencies may be determined necessary by the Army Corp of Engineers in order to issue the permit. A permit may be pursued for each separate outfall consistent with the development phasing.

7. BCDC

Any improvement or proposed structure within Bay or within 100-feet of the Bay shoreline will require a permit from BCDC. A permit for each specific improvement within the 100-foot Bay shoreline may be pursued from BCDC consistent with the development phasing. Alternatively, a "major permit" may be pursued that would provide for a programmatic approval of all the proposed improvements within the 100-foot Bay shoreline. With the "major permit," future review and permits from BCDC will be required once the specific project details are available.

8. US Fish and Wildlife Service

All proposed improvements and structures shall be compliant with the active mitigation measures outlined in the Biological Opinion issued by the US Fish and Wildlife Service, the Declaration of Restrictions described in the EIR and a Memorandum of Agreement with the VA for lighting mitigation measures related to protecting the least turn colony within the VA Property. The City of Alameda will review all proposed improvements to ensure compliance and may request additional consultation from the Service, if necessary.

XIII. MIP FLEXIBILITY

The Land Use Program is expected to adjust throughout the implementation of the backbone infrastructure. Changes in economic conditions, market factors or other unanticipated changes to the development concept are likely to occur during the course of redevelopment of Alameda Point. Accordingly, it is important to understand the potential adjustments to the backbone infrastructure associated with either increases or decreases in the intensity of land uses. This provides limits to the range of potential infrastructure demands at Alameda Point. The MIP has analyzed the Low and High Density Alternative Land Use Programs consistent with the EIR to characterize which components of the backbone infrastructure would require adjustments.

The summary of the land use programs for the Low and High Density Alternatives relative to the Reuse Plan, which the MIP is based upon, are presented in Table 13.

Table 13 - Low and High Density Alternatives Relative to the Reuse Plan

Land Use	1996 Reuse Plan	Low Density Alternative	High Density Alternative
Residential (Single Family)	532	1,000	1,223
Residential (Multi-Family)	822	0	2,177
Subtotal Residential	1,354	1,000	3,400
Office	1,627,500	500,500	852,500
Manufacturing / Warehouse	3,060,500	1,224,500	2,815,500
Retail	300,000	100,000	1,000,000
Service	512,000	285,000	642,000
Agricultural	0	190,000	190,000
Subtotal Commercial	5,500,000	2,300,000	5,500,000

A. Low Density

The Low Density Alternative includes decreases in quantities of both the residential and commercial land use designations. The amounts of residential units are slightly decreased, whereas the commercial square footage is decreased by over 50%. As expected, the infrastructure demands are less for this Alternative. However, since the Alternative maintains the same development footprint, the amount of backbone infrastructure required to be constructed for this Alternative remains similar to the Reuse Plan. There are some infrastructure systems that would be reduced in size since the demand has decreased.

Specifically, the wastewater and potable water demands associated with this Alternative decrease from 2.16 MGD to approximately 1.6 MGD and from 2.06 MGD to approximately 1.7 MGD, respectively. Consequently, the sanitary sewer collection and potable water distribution systems can be reduced in size with this Alternative. See Figure 59 and Figure 61 depicting the adjustments to these systems that could be implemented with this Alternative.

Whereas, the storm drain, dry utility and street systems are expected to remain similar for this Alternative as to what is required for the Reuse Plan. This is largely due to the development footprint of this Alternative remaining consistent with the Reuse Plan.

The decreases to the portions of the wastewater and potable water systems are estimated to reduce the backbone infrastructure construction cost by approximately \$2 million.

B. High Density

The High Density Alternative includes an increase to the quantity of the residential land use designation. The amounts of residential units are increased to 3,400, whereas the overall commercial square footage is maintained the same as Reuse Plan. However, the retail square footage is increased. The infrastructure demands do increase for this Alternative. There are some components of the infrastructure systems that would be increased in size since the demand has increased.

Specifically, the wastewater and potable water demands associated with this Alternative increase from 2.16 MGD to approximately 2.8 MGD and from 2.06 MGD to approximately 3.4 MGD, respectively. Only portions of the sanitary sewer collection and potable water distribution systems will need to be increased in size with this Alternative. See Figure 58 and Figure 60 depicting the adjustments to these systems that could be implemented with this Alternative.

Whereas, the storm drain, dry utility and street systems are expected to remain similar for this Alternative as to what is required for the Reuse Plan.



The increases to portions of the wastewater and potable water systems are estimated to increase the backbone infrastructure construction costs by approximately \$250,000.

C. Implementation

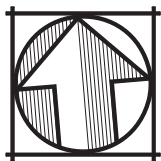
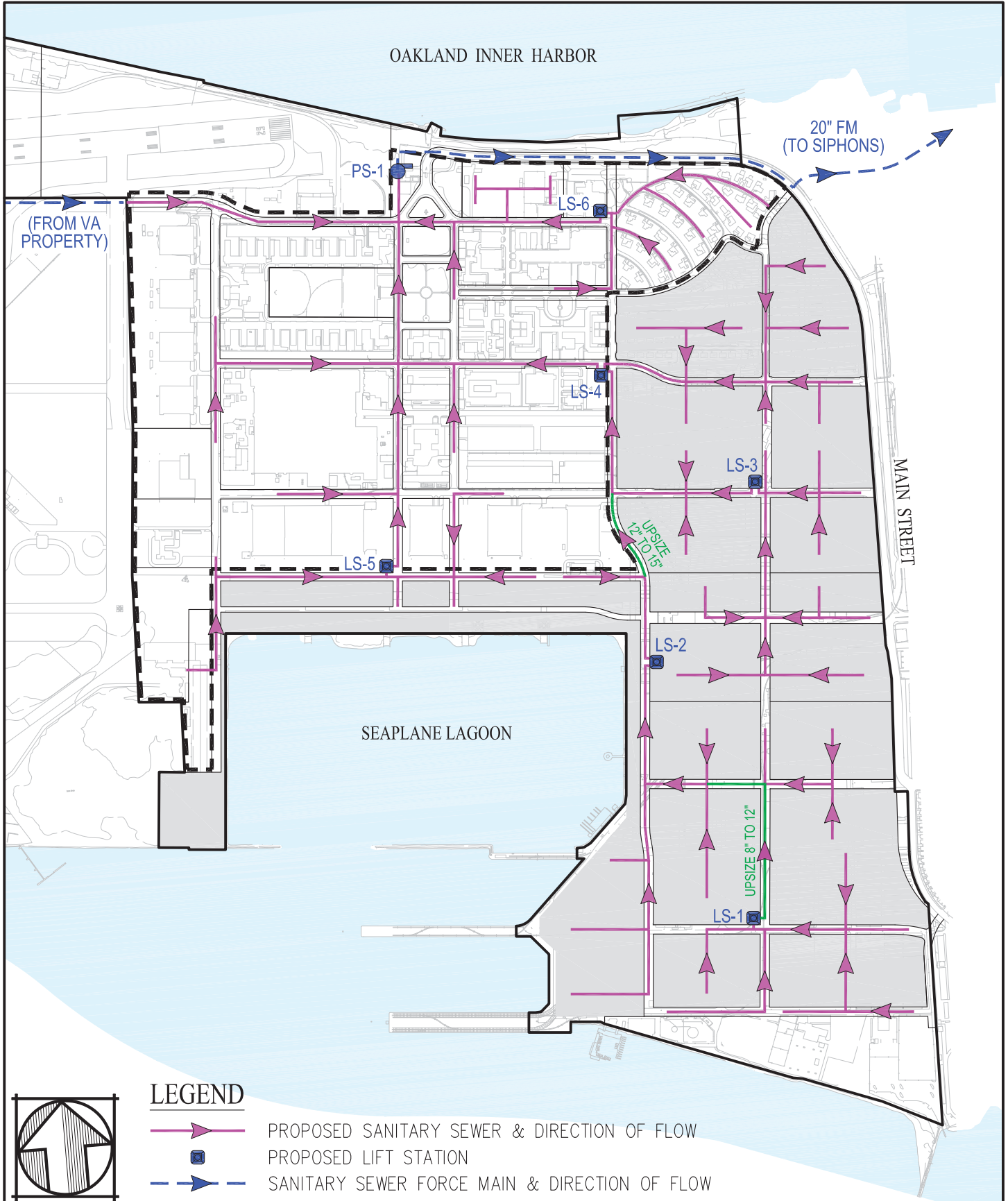
In order to maintain flexibility for future land use changes, the City of Alameda will determine with each sub-phase if any of the backbone infrastructure adjustments described above shall be implemented.



LEGEND

-  PROPOSED SANITARY SEWER & DIRECTION OF FLOW
-  PROPOSED LIFT STATION
-  SANITARY SEWER FORCE MAIN & DIRECTION OF FLOW

**ALAMEDA POINT
MASTER INFRASTRUCTURE PLAN**

CITY OF ALAMEDA ALAMEDA COUNTY CALIFORNIA

DATE: JUNE, 2013 SCALE: 1" = 1,000'

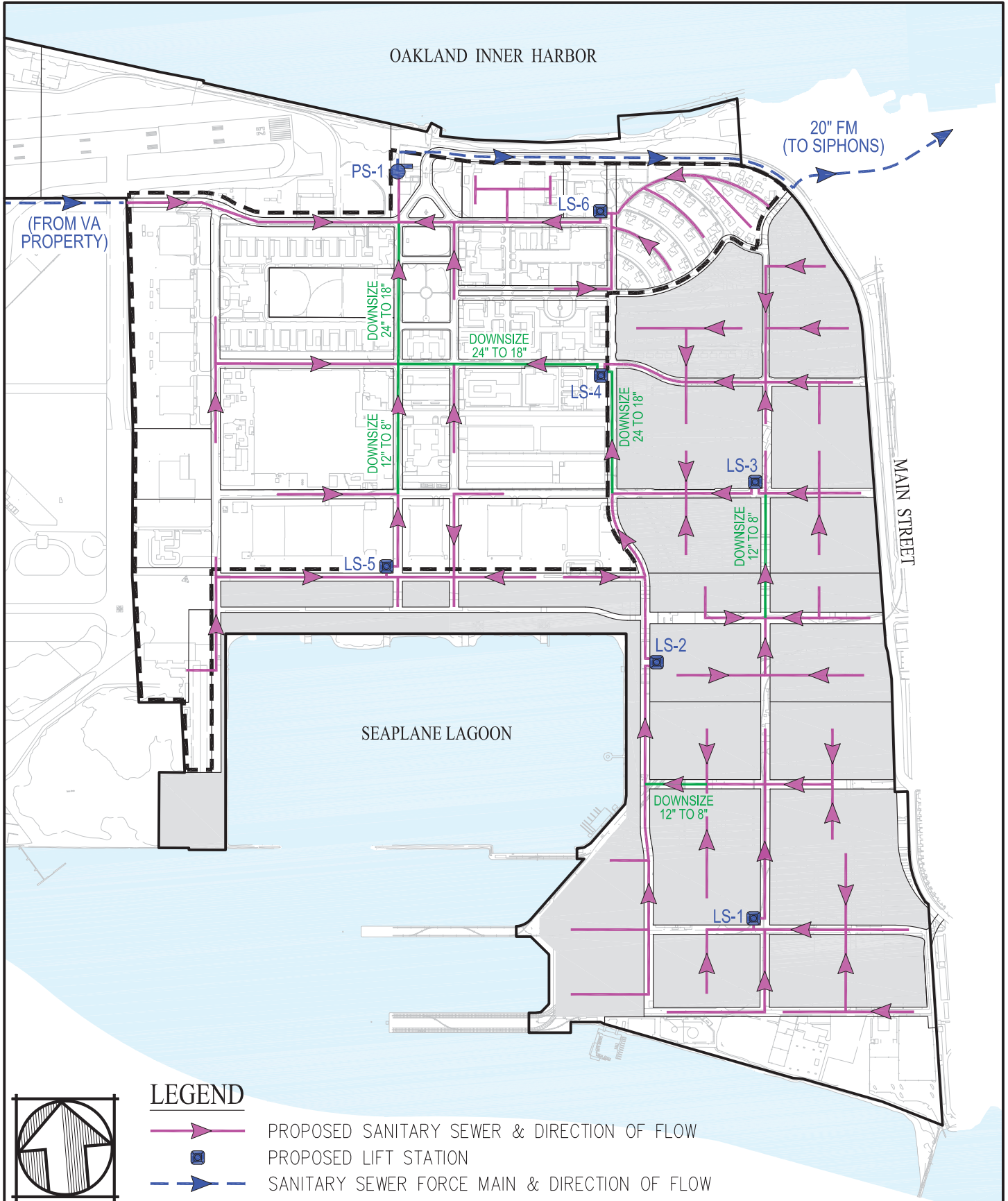

Carlson, Barbee, & Gibson, Inc.

**FIGURE 58
PROPOSED ULTIMATE SEWER SYSTEM
HIGH DENSITY ALTERNATIVE**

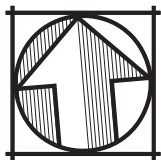

LEGEND



-  PROPOSED SANITARY SEWER & DIRECTION OF FLOW
-  PROPOSED LIFT STATION
-  SANITARY SEWER FORCE MAIN & DIRECTION OF FLOW

**ALAMEDA POINT
MASTER INFRASTRUCTURE PLAN**

CITY OF ALAMEDA ALAMEDA COUNTY CALIFORNIA

DATE: JUNE, 2013 SCALE: 1" = 1,000'

Carlson, Barbee, & Gibson, Inc.

**FIGURE 59
PROPOSED ULTIMATE SEWER SYSTEM
LOW DENSITY ALTERNATIVE**

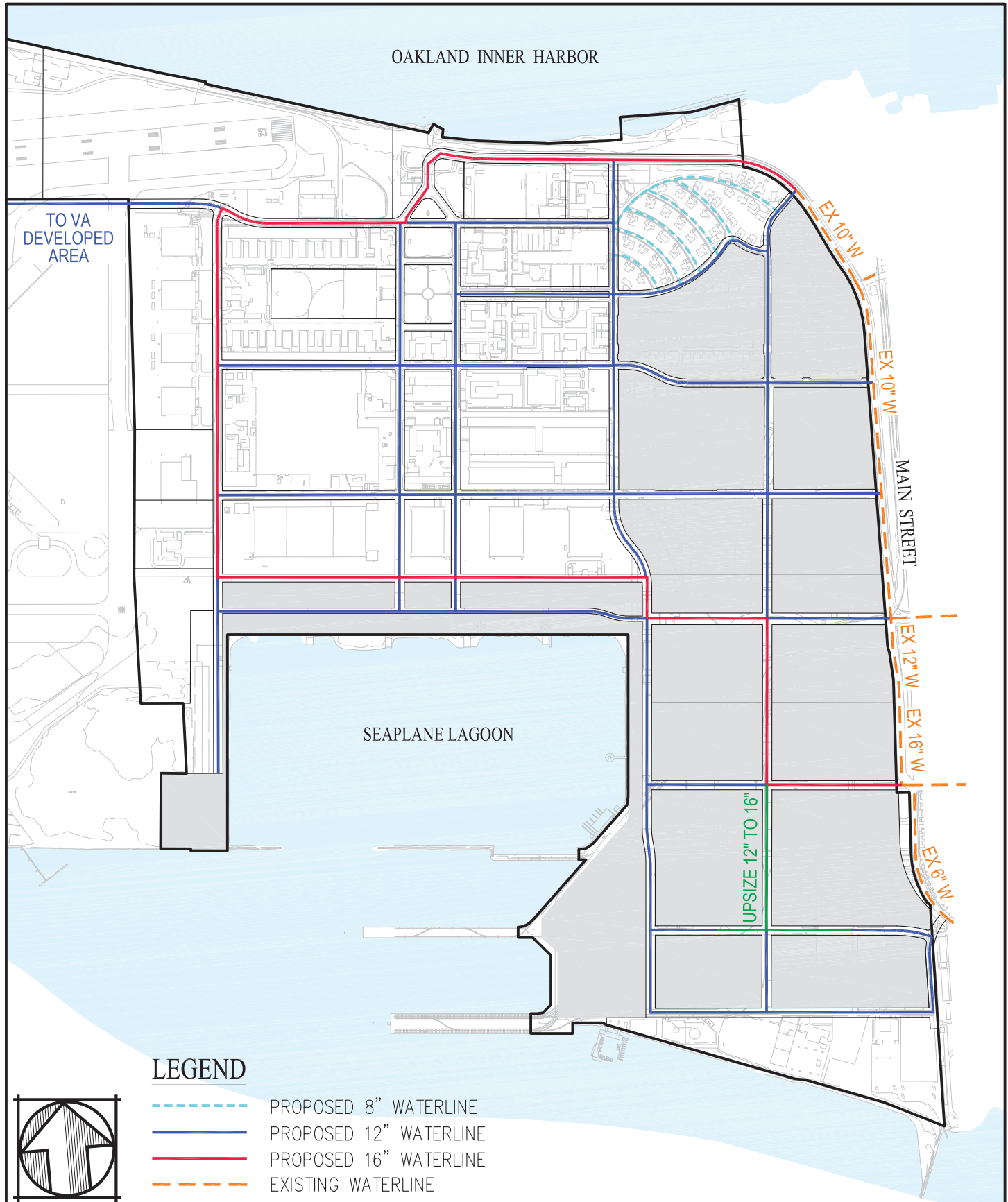

ALAMEDA POINT
 MASTER INFRASTRUCTURE PLAN

CITY OF ALAMEDA ALAMEDA COUNTY CALIFORNIA

DATE: JUNE, 2013 SCALE: 1" = 1,000'

Carlson, Barbee, & Gibson, Inc.

FIGURE 60
 PROPOSED ULTIMATE WATER SYSTEM
 HIGH DENSITY ALTERNATIVE

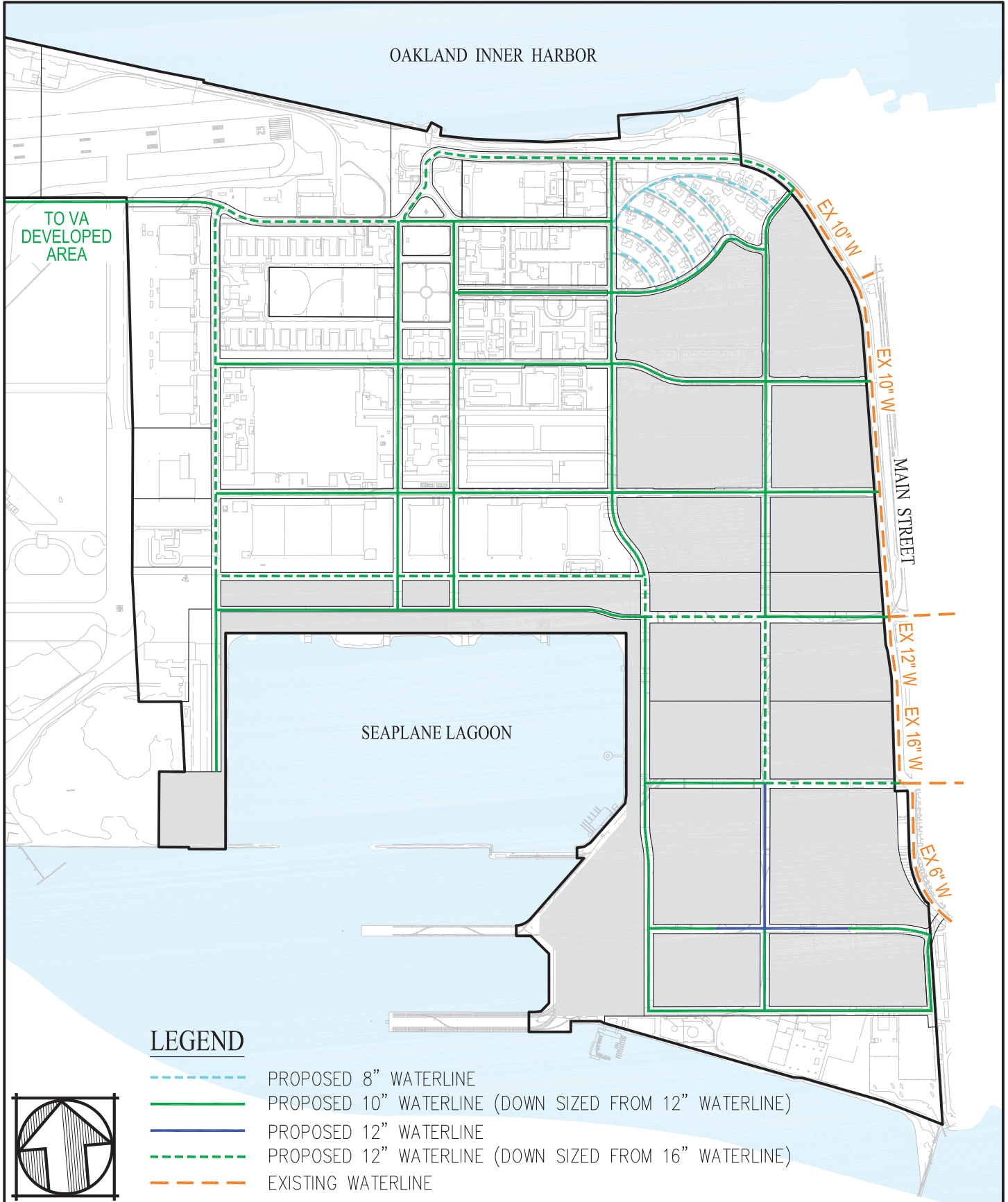

LEGEND

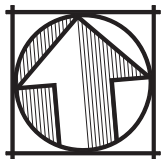

- - - PROPOSED 8" WATERLINE
- PROPOSED 10" WATERLINE (DOWN SIZED FROM 12" WATERLINE)
- PROPOSED 12" WATERLINE
- - - PROPOSED 12" WATERLINE (DOWN SIZED FROM 16" WATERLINE)
- - - EXISTING WATERLINE

ALAMEDA POINT MASTER INFRASTRUCTURE PLAN

CITY OF ALAMEDA ALAMEDA COUNTY CALIFORNIA

DATE: JUNE, 2013 SCALE: 1" = 1,000'

Carlson, Barbee, & Gibson, Inc.

FIGURE 61 PROPOSED ULTIMATE WATER SYSTEM LOW DENSITY ALTERNATIVE

XIV. CONSTRUCTION COSTS

A. Backbone Infrastructure Costs

The Alameda Point backbone infrastructure described in the MIP is estimated to cost approximately \$550 to 575 million. The Project Site is assumed to be constructed in three large phases for cost estimating purposes. See Figure 62 depicting the assumed three phases for the cost estimate. The gross areas within each phase are as follows: Phase 1 = 192 acres, Phase 2 = 139 acres and Phase 3 = 266 acres. Table 14 outlines the various categories of costs for each phase and provides an overall total estimated cost. These construction costs represent the backbone infrastructure only. There are other costs associated with the on-site / in-tract improvements that will be constructed within the development blocks that are not included in this cost estimate.

As discussed in the Phasing and Implementation Section XII, it is likely that the three larger phases will be sub-phased into smaller development areas. The Sub-Phase 1A “North” and “South” scenarios depicted in Figures 56 and 57 represent potential locations and configurations of an initial phase of development at Alameda Point. The backbone infrastructure construction costs associated with the Sub-Phase 1A “North” scenario are estimated to be approximately \$40 million. Sub-Phase 1A “North” includes 23.5 acres of developable area, net of the backbone street rights-of-ways. The backbone infrastructure construction costs associated with the Sub-Phase 1A “South” scenario are estimated to be approximately \$67.5 million. Sub-Phase 1A “South” includes 55 acres of developable area, net of the backbone street rights-of-ways. These estimated costs includes those associated with the improvements necessary to support this initial phase as well as the proportionate contribution from this sub-phase to other site-wide improvements that will be constructed with later phases.

Table 14 - Backbone Infrastructure Construction Costs

	Description	PHASE 1	PHASE 2	PHASE 3	TOTAL
	BACKBONE INFRASTRUCTURE				
1	DEMOLITION / SITE PREPARATION	\$33,919,000	\$42,064,000	\$2,630,000	\$78,613,000
2	ENVIRONMENTAL REMEDIATION	BY OTHERS	BY OTHERS	BY OTHERS	BY OTHERS
3	FLOOD PROTECTION AND SITE GRADING	\$41,483,000	\$40,343,000	\$27,754,000	\$109,580,000
4	DEWATERING	\$3,981,000	\$2,960,000	\$3,281,000	\$10,222,000
5	SANITARY SEWER	\$12,657,000	\$3,255,000	\$4,605,000	\$20,517,000
6	STORM DRAIN	\$13,519,000	\$8,411,000	\$10,916,000	\$32,846,000
7	POTABLE WATER	\$5,314,000	\$4,405,000	\$6,238,000	\$15,957,000
8	RECYCLED WATER	\$1,470,000	\$506,250	\$876,000	\$2,852,250
9	DRY UTILITIES	\$7,221,000	\$5,919,000	\$6,621,000	\$19,761,000
10	ON-SITE STREET WORK	\$23,305,000	\$18,023,000	\$13,933,000	\$55,261,000
11	TRANSPORTATION	\$10,400,000	\$34,206,000	\$-	\$44,606,000
12	PARKS AND OPEN SPACE	\$28,990,000	\$15,898,000	\$20,030,000	\$64,918,000
13	PUBLIC BENEFITS	\$1,250,000	\$16,038,000	\$-	\$17,288,000
	SUBTOTAL (to the nearest \$10,000)	\$183,510,000	\$192,030,000	\$96,880,000	\$472,420,000
	SOFT COSTS				
14	CONSTRUCTION ADMIN	\$5,872,000	\$6,145,000	\$3,100,000	\$15,117,000
15	PROFESSIONAL SERVICES	\$22,021,000	\$23,044,000	\$11,626,000	\$56,691,000
16	FEES	\$7,730,000	\$7,717,000	\$5,016,000	\$20,463,000
17	IMPROVEMENT ACCEPTANCE	\$734,000	\$768,000	\$388,000	\$1,890,000
	SUBTOTAL (to nearest \$10,000)	\$36,360,000	\$37,670,000	\$20,130,000	\$94,160,000
	TOTAL (to the nearest \$10,000)	\$219,870,000	\$229,700,000	\$117,010,000	\$566,580,000

The backbone infrastructure construction costs include demolition, flood protection and site grading, utility systems, on-site street improvements, street improvements off-site as required in the mitigation measures outlined in the EIR, parks and open space and public benefits. These construction costs also include a 25% contingency applied to all costs to account for items that are not fully characterized at this time. Other budgets that are associated with design and construction of the backbone infrastructure are included, such as construction administration, professional services, plan review and inspection, and improvement acceptance. The following is a list of the general categories of improvements included in the cost estimate. Also, see the Appendix for the detailed cost estimate summary which includes the estimated costs associated with each individual improvement.

- Demolition / Site Preparation
 - Demolition and abatement of existing structures
 - Removal and/or slurry filling of existing utilities to be abandoned

- Flood Protection & Site Grading
 - Corrective Geotechnical Measures – shoreline stabilization and liquefaction remediation
 - Construction of perimeter flood protection measures
 - Import of material to raise elevations for perimeter flood protection measures and Development Areas
 - Mass grading of development blocks

- Utility Systems
 - Sanitary sewer system – pipelines, manholes and lift stations
 - Stormwater system – pipelines, manholes, inlets, pump stations, multi-purpose basins and outfalls
 - Potable water system – pipelines, appurtenances and fire hydrants
 - Recycled water system – pipelines and appurtenances
 - Dry utility system – joint trench, conduits, wires, substructure and street lights

- On-Site Street System
 - New on-site street construction – pavement, curbs, gutters, sidewalks, landscaping and striping
 - Reconstruction of existing on-site streets – pavement, curbs, gutters, sidewalks, landscaping and striping
 - Traffic calming

- Transportation Improvements
 - Off-site improvements as outlined in the mitigation measures of the EIR
 - Participation to BRT System
 - Parking lot expansion at the existing ferry terminal
 - New ferry terminal in Seaplane Lagoon
 - Transit center
 - Shuttle system
 - TDM

- Parks and Open Space
 - Seaplane Lagoon frontage
 - Regional Sports Complex
 - Enterprise Park
 - Bay Trail
 - Other parks and open space areas

- Public Benefits
 - Fire station
 - Pro-Rata Share of Public Works satellite corporation yard
 - Bay Trail extension (Northwest Territories & VA Property)

B. Value Engineering and Potential Cost Reductions

The value engineering options that are described throughout the MIP could result in the backbone infrastructure construction costs being reduced by \$21.5 million. The feasibility of implementing these value engineering opportunities will be evaluated through the final design process for the backbone infrastructure. The backbone infrastructure will evolve with the planning of Alameda Point and additional value engineering opportunities are expected to be identified and considered in effort to minimize construction costs, where possible and appropriate.

As previously described, the Dept. of Veteran Affairs is planning a project in the VA Property, west of the Development and Reuse Areas within Alameda Point. This project includes a VA Outpatient Clinic and a Columbarium Cemetery that will require extension of infrastructure systems to this project location. If the VA project is constructed prior to redevelopment commencing in the northwest portions of Alameda Point, specifically within West Redline Avenue and Lexington Street, then the VA will install infrastructure components outside of the VA Property. This infrastructure will provide access and utility service to the Reuse Areas, the Regional Sports Complex and the Northwest Territories. The City of Alameda and the VA have entered into a non-binding term sheet that contains provisions for the scenario that the VA installs infrastructure outside the VA Property. In this scenario, the infrastructure shall be designed to support the future development demand anticipated within Alameda Point. This scenario would result in the VA installing infrastructure improvements that would otherwise need to be installed to support the redevelopment of Alameda Point and therefore reducing the construction costs for Alameda Point by approximately \$12.5 million.

Other cost reductions could be realized by obtaining infrastructure grants or through tax measures that support the construction of infrastructure components with regional benefit. This may include the stabilization of the northern shoreline and transit improvements.

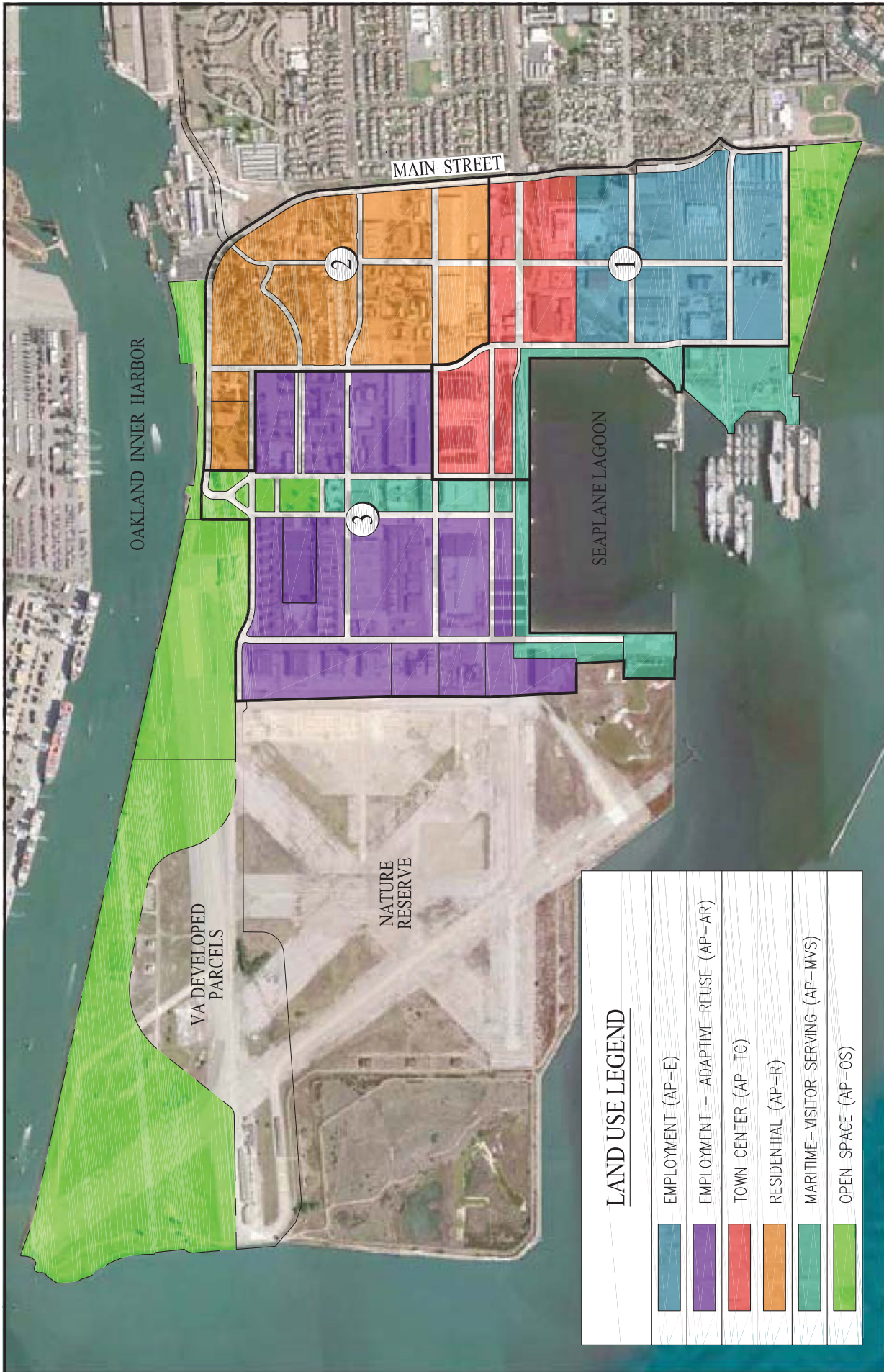

LAND USE LEGEND

	EMPLOYMENT (AP-E)
	EMPLOYMENT - ADAPTIVE REUSE (AP-AR)
	TOWN CENTER (AP-TC)
	RESIDENTIAL (AP-R)
	MARITIME-VISITOR SERVING (AP-MVS)
	OPEN SPACE (AP-OS)

ALAMEDA POINT
MASTER INFRASTRUCTURE PLAN
 CITY OF ALAMEDA ALAMEDA COUNTY CALIFORNIA
 DATE: JUNE, 2013 SCALE: 1" = 1,500'
Carlson, Barbee, & Gibson, Inc.

FIGURE 62
ESTIMATE PHASING

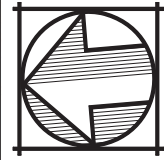

G:\1087-10\ACAD-10\EXHIBITS\BASE CASE ALT - FIGURES\B_62_ESTIMATE PHASING.DWG

REFERENCES

Alameda Point Focus Environmental Newsletter, Spring 2013, prepared by the Department of Navy Base Realignment and Closure

Alameda Point General Plan Amendment EIR, June 2001, City of Alameda

Alameda Point Golf Course Environmental Impact Report, July 2004, prepared by EDWA, Inc.

Alameda Municipal Power Material and Installation Criteria for Underground Electrical Systems, January 12, 2010

Alameda Point Preliminary Development Concept, February 1, 2006, prepared by Roma Design Group

Alameda Point Water System Engineering Study, March 1998, prepared by East Bay Municipal Utility District

Biological Opinion, August 29, 2012, prepared by NS Fish and Wildlife Service

City of Alameda Bike Master Plan, updated 2010, prepared by the City of Alameda

City of Alameda Municipal Code

City of Alameda Standard Subdivision Improvement Specifications and Design Criteria, April 1965

City of Alameda Storm Drain Master Plan, August 2008, prepared by Schaaf and Wheeler Consulting Civil Engineers

Community Exposure to Tsunami Hazards in California, Scientific Investigations Report 2012-5222, prepared by U.S. Geologic Survey, dated 2013

C.3 Stormwater Technical Guidance, Alameda County Cleanwater Program, May 29, 2012

Department of Veteran Affairs, Draft Environmental Assessment, January 2013

East Bay Municipal Utility District Regulations Governing Water Service

East Bay Municipal Utility District Standard Specifications and Standard Drawings, Installations of Water Mains 20-inches and Smaller, July 2008

East Bayshore Recycled Water Project Fact Sheet, December 2011, prepared by East Bay Municipal Utility District

Flood Insurance Study: Tsunami Predictions for Monterey and San Francisco Bays and Puget Sound, November 1974, prepared by US Army Corp of Engineers

Geotechnical Investigation, Oakland Harbor Navigation Improvement (-50 foot) Project, Port of Oakland, February 12, 1999, prepared by Subsurface consultants Inc.

Memorandum regarding geotechnical constraints affecting infrastructure planning, January 30, 2013, prepared by ENGE0, Inc.

NAS Alameda Community Reuse Plan, January 1996, prepared by EDAW, Inc.

National Flood Insurance Program, Flood Insurance Rate Map Numbers 06001C0062G, 06001C0064G, 06001C0066G and 06001C0068G, August 3, 2009, prepared by Federal Emergency Management Agency

Numerical Modeling of Tsunami Effects at Marine Oil Terminals in San Francisco Bay, June 2006, prepared by Borreno, Et Al (Department of Civil Engineering, University of Southern California), prepared for Marine Facilities Division of the California State Lands Commission

Preliminary Geotechnical Exploration, Alameda Point Development, April 8, 2003, prepared by ENGEO, Inc.

Regional Transit Access Study: Volume 1, Overview of Study Corridors, Transit Demand & Service Examples – DRAFT, July 2012, prepared by Nelson Nygaard

Regional Transit Access Study: Volume 2 – DRAFT, September 2012, prepared by Nelson Nygaard

San Francisco Bay Plan, as amended on October 6, 2011, prepared by San Francisco Bay Conservation and Development Commission

San Francisco Bay Tidal Stage vs. Frequency Study, October 1984, prepared by US Army Corp of Engineers, San Francisco District

Stipulated Order for Preliminary Relief, East Bay Municipal Utility District, January 2009

Transportation Element of the City of Alameda General Plan, January 2009, prepared by the City of Alameda

Urban Greening Plan Parks Improvement Assessment, June 2012, prepared by Gates & Associates