

RECORDING REQUESTED BY AND  
WHEN RECORDED RETURN TO:

City Attorney  
City of Alameda  
2263 Santa Clara Avenue  
Alameda, CA 94501

**DA - \_\_\_\_\_**  
**DEVELOPMENT AGREEMENT**  
**REBUILDING THE EXISTING SUPPORTIVE HOUSING AT ALAMEDA**  
**POINT (RESHAP)**

This Development Agreement (“**Agreement**” or “**Development Agreement**”) is entered into on \_\_\_\_\_, 2018 (“**Effective Date**”), between the City of Alameda, a municipal corporation (“**City**”) and MidPen Housing Corporation, a California nonprofit public benefit corporation (“**MidPen**”), Alameda Point Collaborative, a California nonprofit public benefit corporation (“**APC**”), Building Futures With Women and Children, a California nonprofit public benefit corporation (“**Building Futures**”), and Operation Dignity, a California nonprofit public benefit corporation (“**Operation Dignity**”). Each of APC, Building Futures and Operation Dignity is referred to herein as a “**Collaborating Partner**”, and collectively, “**Collaborating Partners**”. MidPen and the Collaborating Partners are referred to herein as the “**Developer**”. MidPen and each of the Collaborating Partners are expected to form limited partnerships to which certain development obligations will be assigned in which the managing general partner is a limited liability company in which (1) MidPen or an affiliate in which MidPen has a Controlling Interest is a member/manager and (2) one or more of the Collaborating Partners or an affiliate in which the Collaborating Partner has a Controlling Interest is also a member/manager, which limited partnerships are identified herein as “**Developer Affiliates**.” The City and the Developer are sometimes collectively referred to in this Agreement as the “**Parties**,” and individually as a “**Party**.” The Parties have entered into this Agreement with reference to the following facts:

**RECITALS**

This Agreement is based on the following facts, understandings and intentions of the Parties:

A. In order to strengthen the public planning process, encourage private participation in comprehensive planning and reduce the economic costs and risk of development, the Legislature of the State of California enacted Section 65864 *et seq.* of the Government Code (the “**Development Agreement Legislation**”) which authorizes the City and a developer having a legal or equitable interest in real property to enter into a binding, long-term development agreement, establishing certain development rights in the real property.

B. Pursuant to California Government Code Section 65864, the City has adopted rules and regulations establishing procedures and requirements for consideration of development agreements. Such procedures and requirements are contained in the Alameda Municipal Code (“**AMC**”) Chapter XXX, Article VII, Code Sections 30-91 through 30-95 (the “**City Development Agreement Regulations**”). This Development Agreement has been processed in accordance with the City Development Agreement Regulations.

C. The City and the Developer have entered into a Disposition and Development Agreement dated as of \_\_\_\_\_, 2018 and approved by the City Council by Ordinance No. \_\_\_\_ (the “**DDA**”), whereby one or more Developer Affiliates intend to acquire from the City a portion of the former Naval Air Station Alameda (“**NAS Alameda**”) more particularly described in Exhibit A, attached hereto (the “**Property**”).

D. The City is desirous of advancing the socioeconomic interests of the City and its residents by promoting the productive use of the former NAS Alameda consistent with the NAS Alameda Community Reuse Plan (the “**Reuse Plan**”) adopted by the Alameda Reuse and Redevelopment Authority in 1996 and subsequently amended in 1997, and encouraging quality development and economic growth, thereby enhancing affordable housing and employment opportunities for residents..

E. The City has determined that development of the Property in accordance with this Development Agreement will accrue clear benefits to the public. These “**Public Benefits**” include, but are not limited to, significant amounts of new affordable housing as well as increased employment opportunities for residents.

F. The “**Project**” is a high quality, affordable supportive housing project that will serve extremely low-income and low-income residents by providing housing and supportive services that will help to break the cycle of homelessness and establish stability and opportunity in the lives of residents and create a cohesive, pedestrian-friendly, and inviting community. The Developer proposes to develop the following specified improvements consistent with the Main Street Neighborhood Plan and the Planning Documents. The Project is more fully described in the Development Plan, which is attached as Exhibit B, herein incorporated by reference without limitation to define the Project as including the following components:

- a. Two-Hundred (200) replacement residential units in newly constructed buildings replacing the 200 units currently located in the Existing Structures (the “**Replacement Units**”);
- b. Sixty-Seven (67) new residential units in newly constructed buildings (“**New Residential Units** and with the Replacement Units, collectively, the “**Residential Units**”);
- c. Approximately 40,000 square feet of permitted and conditionally permitted community serving commercial spaces (“**Commercial Space**”).

G. The City prior to entering into this Development Agreement has undertaken extensive actions in furtherance of redeveloping the former NAS Alameda consistent with the Reuse Plan. A list of all the actions is set forth in the recitals of the DDA and includes General

Plan amendments, Zoning Ordinance amendments (e.g., the creation of the Alameda Point District under Alameda Municipal Code Section 30-4.24), a Transportation Demand Management Plan, and a Master Infrastructure Plan (“**MIP**”) (collectively, the “**Planning Documents**”). Following noticed public hearings, the City Council also approved the following “**Initial Approvals**” for the development of the Project:

- a. The Main Street Neighborhood Specific Plan for the Main Street zoning sub-district adopted on March 21, 2017 by Ordinance No. 3117 (“**Main Street Plan**”).
- b. Certification of a Final Environmental Impact Report (“**FEIR**”) (State Clearinghouse NO. 201312043) under the California Environmental Quality Act (“**CEQA**”), California Public Resources Code Section 2100 et seq. and adoption of written findings and a Mitigation and Monitoring Reporting program (“**MMRP**”) on February 4, 2014, by Resolution NO. 14891, for the Alameda Point Project, including the Main Street Area.
- c. The City Planning Committee approved the Development Plan which sets forth the Project as required under the Main Street Plan and AMC Section 30-4.13(j) (Planning Board Resolution No.PB17-15) (“**Development Plan**”) and concurrently approved a Multi-family Density Bonus Waiver for the project under AMC Section 30-17.

H. After entering into this Development Agreement, the City anticipates applications for additional land use approvals, entitlements, and permits to be submitted to implement and operate the Project in accordance with the terms of the DDA and consistent with the Planning Documents. Such applications may include, without limitation: design review approvals, subdivision maps, improvement plans, development plans, conditional use permits, variances, street vacations, demolition permits, infrastructure agreements, grading permits, building permits, right-of-way permits, lot line adjustments, site plans, sewer and water connection permits, certificates of occupancy, parcel maps, lot splits, landscaping plans, master sign programs, and encroachment permits (collectively, “**Subsequent Approvals**”).

I. Collectively, the Planning Documents and the Initial Approvals are herein referred to as “**Project Approvals**.” When any Subsequent Approval applicable to the Project is approved by the City, each such Subsequent Approval(s) shall become subject to all the terms and conditions of this Development Agreement and shall be considered part of the “**Project Approvals**” under this Development Agreement.

J. The City has determined that by entering into this Development Agreement the City will ensure: (1) the productive use of underdeveloped property and foster orderly growth and quality development in the City; (2) improve existing affordable housing opportunities and increase affordable housing through occupancy and affordability restrictions on the Project in compliance with the Renewed Hope Settlement Agreement and the City's Inclusionary Housing Ordinance and (3) that any development of the Property will proceed in accordance with the goals and policies set forth in the City of Alameda General Plan (“**General Plan**”) and will

implement City's stated General Plan policies.

K. The terms and conditions of this Development Agreement have undergone extensive review by the City, MidPen, and the Collaborating Partners and their respective legal counsel. The Planning Board and the City Council at publicly noticed meetings found the Development Agreement to be in conformance with the General Plan, the Development Agreement Legislation, and the City Development Agreement Regulations. The City Council finds that the economic interests of the City's residents and the public health, safety and welfare will be best served by entering into this Development Agreement.

L. This Development Agreement was adopted by ordinance of the City Council, after notice and public hearings before the Planning Board and City Council. The City Council previously certified the FEIR, which analyzed the Planning Documents. The Initial Approvals are consistent with the findings and conclusions of the FEIR. This Development Agreement and the Initial Approvals qualify for the streamlining provisions of CEQA under California Public Resources Code Section 21083.3 and CEQA Guidelines Section 15183. An environmental checklist for streamlined CEQA was prepared by Staff. The FEIR and CEQA checklist serve as the environmental review for this Development Agreement, and the City Council in approving this Development Agreement has made findings pursuant to Section 15162 of the CEQA Guidelines.

M. The City and Developer for reasons cited herein have determined that the Project is a multi-phased Project for which this Development Agreement is appropriate. This Development Agreement will eliminate uncertainty regarding Project Approvals, including Subsequent Approvals thereby encouraging planning for, investment in and commitment to use and development of the Property. Continued use and development of the Property in accordance with this Development Agreement is anticipated to, in turn, provide substantial benefits and contribute to the provision of needed affordable housing, thereby achieving the goals and purposes for which the Development Agreement Statute was enacted.

## **AGREEMENT**

NOW, THEREFORE, the parties agree as follows:

### **ARTICLE 1.** **APPLICABLE LAW**

**Section 1.1 Applicable Law.** The City shall process, consider and review all Subsequent Approvals in accordance with the rules, regulations, official policies, standards and specifications in effect on the Effective Date of this Development Agreement. This shall include (a) the City's General Plan, Planning and Zoning Code, Subdivision Code, Green Building Regulations and all other applicable City policies, rules and regulations that set forth standards for development, but that are not Uniform Codes as defined in Section 1.4, below, (b) the Planning Documents, Basic Approvals, and Initial Approvals, (c) any permitted Future Changes to the Applicable Law, as defined below, and (d) this Development Agreement (collectively referred to as "**Applicable Law**").

## Section 1.2 Non-Conflicting Changes to Applicable Law.

(a) Any future changes to Applicable Law, and any other rules, regulations, official policies, standards and specifications adopted or enacted after the Effective Date (“**Future Change(s) to Applicable Law**”) that conflict with this Development Agreement and the Project Approvals **shall not** apply to this Project and Property, except that as noted in Section 1.1 above, changes to the TDM Plans shall not be deemed conflicts to the Applicable Law. In the event of such a conflict, the terms of this Development Agreement and the Project Approvals shall prevail.

(b) For purposes of this Section, a Future Change to Applicable Law shall be deemed to conflict with this Development Agreement if it would accomplish any of the following results, either by specific reference to the Project, or as part of a general enactment, which applies to, or affects, the Project:

(1) Limit or reduce the density or intensity of the Project, or any part thereof, or otherwise require any reduction in the square footages of development type (for example, residential, commercial, retail, etc.) or the number of proposed buildings (including the number of residential units) or other improvements from that permitted under this Development Agreement, the Applicable Law, or Project Approvals;

(2) Limit or reduce the height, bulk or massing of the Project or otherwise require any reduction in height, bulk or massing of individual proposed buildings or other improvements from that permitted under the Development Agreement, the Applicable Law, or Project Approvals;

(3) Change any land use designation or permitted use of the Property that is permitted under this Development Agreement, Applicable Law or Project Approvals;

(4) Limit or control the availability of public utilities, services or facilities or any privileges or rights to public utilities, services, or facilities (for example, water rights, water connections or sewage capacity rights, sewer connections, etc.) as considered under the Project Approvals, but only to the extent such public utilities, services or facilities are controlled by the City;

(5) Materially change the location, configuration or size of lots, buildings, structures, or other improvements of the Project in a manner that is inconsistent with or more restrictive than the limitations included in or imposed by the Project Approvals, Applicable Law or this Development Agreement except that for purposes of this provision, the adaptive reuse of existing buildings for non-residential uses shall not be considered a material change;

(6) Limit or control the rate, timing, phasing or sequencing of the approval, development or construction of all or any part of the Project in any manner, except as set forth in this Development Agreement, the DDA, Applicable Law or Project Approvals;

(7) Materially or adversely limit the processing or procuring of applications and approvals of Subsequent Approvals that are consistent with Project Approvals,

Applicable Law or this Development Agreement; or

(8) Increase or impose any Impact Fees or Exactions other than those in effect as of the Effective Date and applicable to the Project as set forth under Section 1.3 of this Development Agreement.

(c) The Developer or the Developer Affiliate may, upon concurrence with any affected City Departments, elect to have Future Changes to Applicable Law that conflict with this Development Agreement apply to the Project by giving the City written notice of its election to have a Future Change to Applicable Law apply, in which case, such Future Change to Applicable Law shall be deemed an Applicable Law. In addition, should the City enact any Future Changes to Applicable Laws that benefit the Project through reduced obligations or increased opportunities, the Project shall have the right to elect to be subject to such Future Changes to Applicable Law.

**Section 1.3 Impact Fees.** The Project and Property shall only be subject to the Development Impact Fees (“Impact Fees”), as set forth in Exhibit C. The City shall not impose any new Impact Fees on the development of the Project or the Property, or impose new exactions for the right to develop the Project (including required contributions of land, public amenities or services) except as set forth in this Development Agreement. The applicable Developer Affiliate shall not be subject to new categories of Impact Fees that are adopted by the City from and after the Effective Date in connection with the development of the Project or Property. Any substitute Impact Fees that replace (but do not expand the purpose or scope of) any Impact Fees shown on Exhibit C shall apply to the Project, and shall not be considered new categories of Impact Fee as set forth above. In addition, any new conditions or requirements, including new costs or fees, identified in the TDM Plans for the Project and Property shall not be considered new Impact Fees as set forth above. If the City reduces the amount of any Impact Fees shown on Exhibit C, the Project will be subject to the lesser amount.

(a) Impact Fees. “**Impact Fees**” shall mean monetary fees, exactions or impositions, other than taxes or assessments, whether established for or imposed upon the Project individually or as part of a class of projects, that are imposed by City on the Project in connection with any Project Approval (including Subsequent Approvals) for any purpose, including, without limitation, defraying all or a portion of the cost of public services and/or facilities construction, improvement, operation and maintenance attributable to the burden created by the Project. For purposes of this Agreement, the term Impact Fees shall not include impact fees imposed on the Project by the Alameda Unified School District, the State of California or any political subdivision of the State except the City. Any fee, exaction or imposition imposed on the Project by the City that does not fit the definition of a Processing Fee, as set forth in Section 1.3(b) below, is an Impact Fee.

(1) Only the Impact Fees (including the applicable inflator, if any) listed on Exhibit C of this Development Agreement shall apply to the Project. The base year for any Impact Fee inflator shall be 2018.

(2) The Alameda Point Development Impact Fees listed in Exhibit C, and imposed pursuant to AMC Section 27.4, will be waived for the Project if the Infrastructure Package is constructed by the adjacent market rate property owner consistent with the terms of

the DDA.

(3) The applicable Developer Affiliate shall receive a credit or waiver toward the Non-Residential Affordable Housing Fee listed in Exhibit C, and imposed pursuant to AMC Section 27, for the construction of 267 on-site affordable housing units, which is 100% of the units to be constructed as set forth in the DDA.

(4) The Public Art requirement pursuant to AMC Section 30.98 shall be waived by the City in exchange for the Developer constructing the 267 on-site affordable housing units.

(b) Processing Fees. “**Processing Fees**” shall mean fees charged to the Project to cover the cost of the City’s review of applications for any permit or other review by the City departments and are not considered Impact Fees. Applications for Subsequent Approvals for the Project shall be charged the then-applicable Processing Fees to allow the City to recover its actual and reasonable costs. The applicable Developer Affiliate shall not receive any protection from rate escalators or rate increases on Processing Fees.

(c) Nothing in this Development Agreement shall diminish or eliminate any of Developer’s rights as set forth in California Government Code Section 66020. The City and Developer acknowledge that the provisions contained within this section are intended to implement the intent of the Parties that the Developer have the right to develop the Project, and the Property, pursuant to specified and known criteria and rules, and that the City receive the benefits which will be conferred as a result of such development without abridging the right of the City to act in accordance with its powers, duties and obligations.

**Section 1.4 Applicability of Uniform Codes.** Before commencing any construction on the Property, the applicable Developer Affiliate must obtain all necessary building or other permits required for such work as required under applicable law (including those permits required by Applicable Law and applicable Future Changes to Applicable Law). In considering applications for building permits, the City shall apply the provisions, requirements, rules, or regulations applicable City-wide that are contained in the California Building Standards Code, as amended by the City in accordance with the California Health and Safety Code, including requirements of the City of Alameda Building and Housing Code, Fire Code, Sewer and Water Code, or other uniform construction codes (collectively, the “**Uniform Codes**”). In addition, upon submittal of a Design Review Application, City Departments shall apply their then-existing technical design standards and specifications with respect to public improvements to be dedicated to that City department, including any applicable standards or requirements of Non-City Responsible Agencies with jurisdiction (the “**Department Design Standards**”), so that public improvements integrate and function with existing City systems and applicable law; provided, however, that (i) the City cannot impose standards or requirements that exceed the minimum City standards; and (ii) such application shall not materially alter the location and dimensions of the streets and easements and sidewalks as set forth in the Development Plan, Main Street Plan and MIP. The Parties understand and agree that any public improvement identified in this Development Agreement, the DDA or the MIP will become part of a larger City system and that the proposed public improvements must be constructed so as to integrate and work with the existing City systems in every material respect.

**Section 1.5 Changes in State and Federal Rules and Regulations.** Notwithstanding any provision in this Development Agreement to the contrary, each City department having jurisdiction over the Project shall exercise its sole discretion under this Development Agreement in a manner that is consistent with the public health and safety and shall at all times retain its respective authority to take any action that is necessary to protect the health and safety of the public (the “**Public Health and Safety Exception**”) or to comply with changes in Federal or State law, including applicable federal and state regulations (the “**Federal or State Law Exception**”), including the authority to condition or deny a Subsequent Approval or to adopt a new City regulation applicable to the Project so long as such condition or denial, or new regulation, is limited solely to addressing a specific and identifiable issue related to the protection of the public health and safety, or compliance with a Federal or State law, and not for independent discretionary policy reasons that are inconsistent with this Development Agreement.

(a) Pursuant to Section 65869.5 of the Development Agreement Statute, in the event that state or federal laws or regulations enacted after this Development Agreement have gone into effect and preclude or prevent compliance with one or more provisions of this Development Agreement, such provisions shall be modified or suspended as may be necessary to comply with such state or federal laws or regulations. In such event, this Development Agreement shall be modified only to the extent necessary, or required, to comply with such law or regulation. In the event that either Party believes, in its reasonable judgment, that any such modifications render the Project economically infeasible for the Developer or materially reduce the economic value of the Public Benefits to the City, the Parties may then negotiate additional amendments to this Development Agreement as may be necessary to satisfy, in their reasonable discretion, both the Developer and City. If the Parties cannot reach agreement on additional amendments despite good faith negotiations for a period of no less than nine (9) months from the Effective Date, then either Party shall have the right to terminate this Agreement in accordance with the provisions of Article 10 herein.

(b) This Development Agreement has been entered into in reliance upon the provisions of the Development Agreement Legislation and City Development Agreement Regulations as those provisions existed as of the Effective Date. No amendment or addition to those provisions which would affect the interpretation or enforceability of this Development Agreement or increase the obligations or diminish the development rights to Developer hereunder, or increase the obligations or diminish the benefits to the City shall be applicable to this Development Agreement unless such amendment or addition is specifically required by law or is mandated by a court of competent jurisdiction. If such amendment or change is permissive rather than mandatory, this Development Agreement shall not be affected. The Parties shall cooperate and shall undertake such actions as may be necessary to implement and reflect the intent of the Parties to allow and encourage development of the Project.

**Section 1.6 Compliance with Applicable Federal and State Laws.** The Developer shall comply, at no cost to the City, with all applicable federal or state laws relating to the Project or the use, occupancy or development of the Property under this Development Agreement.



**ARTICLE 2.**  
**DEVELOPMENT OF PROPERTY**

**Section 2.1 Development Rights.** Developer shall have the vested right to develop the Property in accordance with and subject to the provisions of this Development Agreement, the DDA, and Project Approvals, including any Subsequent Approvals, all of which shall control the overall design, development and construction of the Project including, without limitation, all improvements and appurtenances therewith, the permitted and conditional uses, the density and intensity of uses, the maximum height, bulk and massing of buildings, the number of permitted and required parking spaces and all mitigation measures required to minimize or eliminate material adverse environmental impacts of the Project under the MMRP. This Development Agreement, by stating that the terms and conditions of the Development Agreement, the DDA and Project Approvals control the overall design, development and construction of the Project, is consistent with the requirements of California Government Code Section 65865.2, which requires that a development agreement state permitted uses of the property, the density or intensity of use, the maximum height and size of proposed buildings and provisions for reservation or dedication of land for public purposes. The Developer agrees that all improvements on the Property shall be constructed in accordance with this Development Agreement, the DDA and any Project Approvals, and in accordance with all applicable laws.

**Section 2.2 Compliance with CEQA.** The Parties acknowledge that the FEIR prepared complies with CEQA. The Parties further acknowledge that (a) the FEIR contains a thorough analysis of the Project and possible alternatives to the Project, (b) mitigation measures have been adopted to eliminate or reduce to an acceptable level certain adverse environmental impacts of the Project, and (c) the City Council adopted a statement of overriding considerations in connection with the Basic Approvals, pursuant to CEQA Guidelines Section 15093, for those significant impacts that could not be mitigated to a less than significant level. For these reasons and, consistent with the CEQA streamlining policies applicable to specific plans, the City acknowledges that in connection with Subsequent Approvals it is not obligated to prepare supplemental or subsequent EIRs, mitigated negative declarations, or negative declarations unless required by Public Resources Code Section 2116, and CEQA Guidelines Sections 15161 or 15162. The City shall rely on the streamlining provisions referenced in CEQA Guidelines Sections 15182 and/or 15183 to the fullest extent permitted by law. The City does not intend to conduct any further environmental review or mitigation under CEQA for any aspect of the Project vested by this Development Agreement, except as may be required by applicable law in taking future discretionary actions relating to the Project.

**Section 2.3 Subsequent Approvals.** The Developer and City acknowledge and agree that Developer intends to submit applications for Subsequent Approvals, as defined herein. In connection with any Subsequent Approval, the City shall conduct its review as set forth in the Main Street Neighborhood Specific Plan and exercise its discretion in accordance with Applicable Law, Project Approvals and, as provided by this Development Agreement, which grants the Developer a vested right to develop the Project in one or more phases, as that term is defined in **Section F** of the Recitals above.

(a) The Project shall be phased with construction and development occurring as set forth in the DDA and the attached Initial Phasing Plan, which is herein incorporated as

Exhibit D (referred to as “**Development Phases**”). The Project shall be required to provide the permanently affordable housing in accordance with the Affordable Housing Requirements as outlined in Section 6 of the DDA.

(b) Each Project Approval or Subsequent Approval shall remain in effect during the Term of this Agreement, including any Design Review, Conditional Use approval and/or Variance granted thereunder. Notwithstanding anything to the contrary above, each street improvement, building, grading, demolition or similar permit and any use permit shall expire at the time specified in the permit or the applicable public improvement agreement approved under the City’s Subdivision Code, with extensions as normally allowed under the Uniform Codes or as set forth in such public improvement agreement.

**Section 2.4 Other Government Permits.** The Parties acknowledge that certain aspects of the Project including certain community improvements and/or public improvements may require the approval of federal, state and local governmental agencies that are independent of the City and not a Party to this Agreement (“**Non-City Responsible Agencies**”). The City shall cooperate with reasonable requests by the applicable Developer Affiliate, to the extent appropriate and as permitted by law, to assist in applicable Developer Affiliate’s efforts to obtain, as may be required, permits and approvals from Non-City Responsible Agencies. The applicable Developer Affiliate shall reimburse the City for reasonable costs that are incurred in assisting applicable Developer Affiliate obtain Project specific permits and approvals from Non-City Responsible Agencies.

**Section 2.5 Development Timing.** The Parties currently anticipate that the Project will be constructed in Development Phases over approximately ten (10) years. The timing and commencement of Development Phases is set forth in the DDA, which is herein incorporated by reference as if set forth in full. In particular, and not in any limitation of any of the foregoing, since the California Supreme Court held in Pardee Construction Co. v. The City of Camarillo, 37 Cal.3d 465 (1984), that the failure of the parties therein to consider and expressly provide for the timing of development resulted in a later-adopted initiative restricting the timing of development prevailing over such parties’ agreement, it is the Parties’ desire to avoid that result by acknowledging that the Developer shall have the vested right to develop the Project in such order, and at such rate and at such times, as the Developer deems appropriate in the exercise of its business judgment, subject to the terms, requirements and conditions of the Project Approvals, the DDA, and this Development Agreement. Subject to the deadlines contained in this Development Agreement and the DDA, the Developer will use its best efforts, in accordance with its own business judgment and taking into consideration market conditions and other economic factors influencing Developer's business decision, to commence or to continue development, and to develop the Project in a regular, progressive and timely manner in accordance with the provisions and conditions of this Development Agreement, the DDA, and the Project Approvals. Notwithstanding the above, the Developer acknowledges that the DDA imposes certain phasing and timing requirements on the Developer in the development of the Project and nothing herein is intended to abrogate those requirements.

**Section 2.6 Cooperation.**

(a) Agreement to Cooperate. The Parties agree to cooperate with each other to

expeditiously implement the Project in accordance with the Project Approvals and this Development Agreement, and to undertake and complete all actions or proceedings reasonably necessary or appropriate to ensure that the objectives of the Planning Documents and Basic Approvals are fulfilled during the Term. Nothing in this Development Agreement obligates the City to spend any sums of money or incur any costs other than costs that the Developer must reimburse through the payment of Processing Fees. Nothing in this Development Agreement obligates the Developer to proceed with the Project, including without limitation the filing of applications associated with any Development Phase, unless the Developer chooses to do so in its sole discretion.

(b) Role of Community Development Department. Parties agree that the Community Development Department will act as the City's lead agency to facilitate coordinated City review of applications for Development Plans, Design Review and Subsequent Approvals. As such, Community Development staff will: (i) work with the applicable Developer Affiliate to ensure that all such applications are technically sufficient and constitute complete applications and (ii) interface with City staff responsible for reviewing any application under this Development Agreement to ensure that the City's review of such applications is concurrent and that the approval process is efficient and orderly and avoids redundancies.

(c) City Department Review of Individual Permit Applications. Following issuance of Design Review approval as set forth in this Development Agreement, the Parties agree to prepare and consider applications for construction level approvals, including any improvement plans, subdivision maps, as follows: the applicable Developer Affiliate will submit each application, including applications for the design and construction of public and/or community improvements, to applicable City Departments which will review submittals for consistency with any prior Project Approvals and use good faith efforts to provide comments and make recommendations to the applicable Developer Affiliate within thirty (30) days of the City Department's receipt of such application. The City shall exercise its discretion in reviewing such applications based on the Applicable Law in accordance with Article 1 of this Development Agreement. Any City Department denial of an application under this section shall include a statement of the reasons for such denial. The applicable Developer Affiliate will work collaboratively with the City Departments to ensure that such application is discussed as early in the review process as possible and that the applicable Developer Affiliate and the City act in concert with respect to these matters.

## **Section 2.7 Subdivision Maps.**

(a) Developer may from time to time file subdivision map applications with respect to some or all of the Property in accordance with the provisions in the DDA and the City of Alameda Subdivision Code. The City shall exercise its discretion in reviewing such subdivision map applications in accordance with this Section 2.7 and the City of Alameda Subdivision Code. Upon approval of each Tentative Map or Vesting Tentative Map (as those terms are defined in the City of Alameda Subdivision Code), the term of such Tentative Map shall be extended until the Termination of this Development Agreement notwithstanding any other City Law, provided that approvals obtained in the last five years of the Term shall extend for the greater of (a) the Term of this Development Agreement or (b) the maximum applicable

time provided for under City law. A condition to the approval of any Vesting Tentative Map shall be that the ordinances, policies and standards applicable to the Vesting Tentative Map shall be the Applicable Law and any Future Changes to Applicable Law as set forth in this Development Agreement, and notwithstanding anything to the contrary in Section 66474.2 of the Subdivision Map Act or the City of Alameda Subdivision Code.

(b) Vesting Tentative Maps. If any tentative map heretofore or hereafter approved in connection with development of the Property is a vesting tentative map under the Subdivision Map Act, and if this Development Agreement is determined by a final judgment to be invalid or unenforceable insofar as it grants a vested right to Developer for development of the Project, then and to that extent all rights and protections afforded Developer under the laws and ordinances applicable to vesting tentative maps shall survive.

### **ARTICLE 3.** **OBLIGATIONS OF DEVELOPER**

**Section 3.1 Cooperation by Developer.** MidPen and the Collaborating Partners, as applicable, shall, in a timely manner, provide all documents, applications, plans and other information necessary for the City to comply with its obligations under this Development Agreement and the DDA and shall comply, in a timely manner, with all reasonable requests by the Community Development Director and each City Department for production of documents or other information evidencing compliance with this Development Agreement.

**Section 3.2 Completion of Project.** Upon commencement of a Development Phase and/or building, the applicable Developer Affiliate shall diligently prosecute its completion under the terms and conditions set forth in the DDA and nothing in this section shall impose a different obligation on the applicable Developer Affiliate to complete a particular phase of construction than is set forth in the DDA, and where this section and the terms of the DDA conflict, the DDA shall prevail. The foregoing notwithstanding, expiration of any building permit or other Project Approval shall not limit the Developer's vested rights as set forth in this Development Agreement, and the Developer shall have the right to seek and obtain subsequent building permits or approvals consistent with this Development Agreement at any time during the Term.

**Section 3.3 Compliance with Conditions and CEQA Mitigation Measures.** The Developer shall comply with all applicable conditions of the Project Approvals, and shall comply with all mitigation measures imposed upon the Project pursuant to CEQA.

(a) The Parties expressly acknowledge that the FEIR and the associated MMRP applies to the Project Approvals and any Subsequent Approvals to the extent appropriate and permitted under applicable law.

(b) Nothing in this Agreement shall limit the ability of the City to impose conditions on any new discretionary permit resulting from changes to the Project from that set forth in the Project Approvals if such conditions are determined by the City to be necessary to mitigate adverse environmental impacts identified through the CEQA process, and associated with the granting of such permit, or as otherwise required to address significant environmental impacts, as defined by CEQA, created by the approval of such permit; provided, however, any

such conditions must be in accordance with Applicable Law.

**Section 3.4 Progress Reports.** MidPen and the Collaborating Partners or their assignees, as applicable, shall make reports of the progress of construction of the Project in such detail and at such time as the Community Development Director reasonably requests and any such reports required and provided under the DDA shall satisfy this provision.

**Section 3.5 Payment of Fees and Costs.**

(a) The applicable Developer Affiliate shall pay to the City all Impact Fees Exactions applicable to the Project or the Property in a timely manner as set forth by Applicable Law or permitted Future Changes to Applicable Law, if applicable, and in compliance with the terms of this Development Agreement and the DDA.

(b) The applicable Developer Affiliate shall pay to the City all Processing Fees applicable to the processing or review of applications in a timely manner and as required under the Alameda Municipal Code.

(c) The City shall not be required to process any requests for approval or take other actions under this Development Agreement during any period in which payments from a Developer Affiliate are past due. If such failure continues for a period of more than ninety (90) days following receipt of notice, it shall be a Default for which City shall have all rights and remedies as set forth in Article 10.

**Section 3.6 Nexus/Reasonable Relationship Waiver.** Developer consents to, and waives any rights it may have now or in the future, to challenge with respect to the Project or the Project Approvals, the legal validity of, the conditions, requirements, policies, or programs required by this Development Agreement or the Applicable Law, including, without limitation, any claim that they constitute an abuse of police power, violate substantive due process, deny equal protection of the laws, effect a taking of property without payment of just compensation, or impose an unlawful tax. In the event Developer challenges any Future Change to an Applicable Law, or any increased or new fee permitted under Section 1.3, then City shall have the right to withhold additional development approvals or permits until the matter is resolved; provided, however, Developer shall have the right to make payment or performance under protest, and thereby receive the additional approval or permit while the matter is in dispute.

**Section 3.7 Taxes.** Nothing in this Agreement limits the City's ability to impose new or increase taxes or special assessments, or any equivalent or substitute tax or assessment, provided (i) the City shall not institute on its own initiative proceedings for any new or increased special tax or special assessment for a land-secured financing district other than those contemplated in the DDA that includes the Property unless the new district is City-wide or Developer gives its prior written consent to such proceedings, and (ii) no such tax or assessment shall be targeted or directed at the Project, including, without limitation, any tax or assessment targeted solely at the Property. Nothing in the foregoing prevents the City from imposing any tax or assessment against the Property, or any space therein, that is enacted in accordance with law and applies to similarly situated property on a City-wide basis. Notwithstanding the above, the City may in its discretion include the Property in an infrastructure financing district or similar type of district that uses property tax increment to provide financing as long as the creation of

such a district does not result in an increase in the property taxes on the Property.

**Section 3.8 Developer’s Right to Rebuild.** The City agrees that Developer may renovate or rebuild portions of the Project at any time within the Term of this Development Agreement should it become necessary due to natural disaster or changes in seismic requirements. Such renovations or reconstruction shall be processed as a Subsequent Project Approval; provided, however, Developer shall be entitled to rebuild the same number of units and ancillary facilities approved in the original Project Approval. Any such renovation or rebuilding shall be subject to all design, density and other limitations and requirements imposed by this Development Agreement, and shall comply with the Project Approvals, the Uniform Codes existing at the time of such rebuilding or reconstruction, and the requirements of CEQA.

**Section 3.9** Failure of MidPen and the Collaborating Partners to timely comply with or implement the obligations in this Article 3 shall be deemed a Breach of this Development Agreement under Section 10.2(a) subject to the provisions of Section 10.2(b)(1) related to cross-defaults..

#### **ARTICLE 4.** **CITY OBLIGATIONS**

**Section 4.1 No Action to Impede Project Approvals.** The City shall take no action nor impose any condition that would conflict with this Development Agreement or the Project Approvals. An action taken or condition imposed shall be deemed to be “in conflict with” this Agreement or the Project Approvals if such actions or conditions result in one or more of the circumstances identified in Section 1.2(b) of this Development Agreement.

**Section 4.2 Expeditious Processing.** To the extent a Subsequent Approval requires an action to be taken by the City, the City shall process such Subsequent Approvals in accordance with the procedures set forth in the AMC, except as amended herein and in cooperation with the Developer as provided in Section 2.6 above.

**Section 4.3 Processing During Third Party Litigation.** The filing of any third party lawsuit(s) against the City or Developer relating to this Development Agreement, the Project Approvals, Subsequent Approvals, or any other action taken in furtherance of the Project including actions related to the Property outside the control of the City or Developer, shall not delay or stop the development, processing or construction of the Project or the issuance of Subsequent Approvals unless the third party obtains a court order preventing the activity.

**Section 4.4 Criteria for Approving Implementing Approvals.** The City may approve an application for a Subsequent Approval subject to any conditions necessary to bring the Project into compliance with this Development Agreement, Project Approvals, Applicable Law, or permitted Future Changes to Applicable Law. If the City denies any Subsequent Approval that implements the Project as contemplated by the Project Approvals, the City must specify in writing the reasons for such denial and may suggest modifications.

**Section 4.5 Coordination of Off-Site Improvements.** The City will use reasonable efforts to assist Developer in coordinating construction of offsite improvements specified in an

approved Development Phase in a timely manner; provided, however, City shall not be required to incur any costs in connection therewith.

## **ARTICLE 5.** **MUTUAL OBLIGATIONS**

**Section 5.1 Notice of Completion or Revocation.** Upon the Parties' completion of performance or revocation of this Development Agreement, a written statement acknowledging such completion or revocation, signed by the appropriate agents of the City and Developer, shall be recorded in the Official Records.

**Section 5.2 Estoppel Certificate.** Developer may, at any time, and from time to time, deliver written notice to the Community Development Director requesting that the Community Development Director certify in writing that to the best of his or her knowledge: (i) this Development Agreement is in full force and effect and a binding obligation of the Parties; (ii) either this Development Agreement has not been amended or modified either orally or in writing, or if so amended or modified, identifying the amendments or modifications and stating their date and nature; (iii) either Developer is not in default in the performance of its obligations under this Development Agreement, or if in default, to describe therein the nature and amount of any such defaults; and (iv) the findings of the City with respect to the most recent annual review performed pursuant to Article 7 below. A Party receiving a request under this Section 5.2 shall execute and return such certificate within thirty (30) days following receipt of the request. Each Party acknowledges that any mortgagee with a mortgage on all or part of the Property, acting in good faith, may rely upon such a certificate. A certificate provided by the City establishing the status of this Development Agreement with respect to any lot or parcel shall be in recordable form and may be recorded with respect to the affected lot or parcel at the expense of the recording party.

### **Section 5.3 Cooperation in the Event of Third-Party Challenge.**

(a) The Parties shall cooperate in defending against any legal action or proceeding instituted challenging the validity of any provision of this Development Agreement, the Project Approvals, including any action taken pursuant to CEQA, or other approval under federal, state or City codes, statutes, codes, regulations, or requirements, and any combination thereof relating to the Project or any portion thereof ("**Third-Party Challenge**"). In the event of a Third-Party Challenge, the City shall promptly notify Developer of any Third-Party Challenge instituted against the City.

**Section 5.4 Good Faith and Fair Dealing.** The Parties shall cooperate with each other and act in good faith in complying with the provisions of this Development Agreement and implementing the Project Approvals and shall, in the course of their performance under this Development Agreement, cooperate and undertake such actions as may be reasonably necessary to implement the Project.

**Section 5.5 Other Necessary Acts.** Each Party shall use good faith efforts to take such further actions as may be reasonably necessary to carry out this Development Agreement and the Project Approvals in accordance with the terms of this Development Agreement (and subject to all applicable laws) and to provide and secure each Party the full and complete enjoyment of its

rights and privileges hereunder.

**ARTICLE 6.**  
**EFFECTIVE DATE AND TERM**

**Section 6.1 Effective Date; Term.** The Effective Date of this Development Agreement is stated in the first paragraph of this Development Agreement and represents the later of: (a) thirty (30) days after the date the Ordinance approving this Development Agreement is adopted by the City Council; or, (b) if a referendum petition is timely and duly circulated and filed, the date the election results on the ballot measure by City voters approving this Development Agreement are certified by the City Council in the manner provided by the Elections Code. This Development Agreement shall be executed by the City within ten (10) days after the Effective Date and recorded as provided in Government Code Section 65868.5, unless the parties mutually agree to a later date for recordation.

(a) **Term.** The term of this Development Agreement is ten (10) years, beginning on the Effective Date. The Term has been established by the Parties as a reasonable estimate of the time required to develop the Project and obtain the Public Benefits. In establishing and agreeing to such Term, the City has determined that the Project Approvals and this Development Agreement incorporate sufficient provisions to permit City to adequately monitor and respond to changing circumstances and conditions in granting permits and approvals and undertaking actions to carry out the development of the Project. The Term shall be extended to the extent that the term of the DDA is extended.

(b) **Termination Following Expiration.** Following the expiration of the Term, or the earlier completion of development of the Project and all of Developer's obligations in connection therewith, this Development Agreement shall be deemed terminated and of no further force and effect, subject, however, to the provisions of Sections 5.3, 10.3, 10.4 and 10.5 hereof.

**ARTICLE 7.**  
**ANNUAL REVIEW**

**Section 7.1 Initiation of Review.** Developer shall notify the City in writing at least forty-five (45) days prior to the anniversary of the Effective Date requesting an annual review of the Development Agreement. The periodic review of the Development Agreement shall be made at least every twelve (12) months, consistent with Government Code Section 65865.1 and AMC Section 30-95.1.

**Section 7.2 Review Procedure.** At least thirty (30) days prior to each anniversary of the Effective Date during the term of this Development Agreement, Developer shall submit a written report to City outlining its efforts toward good faith compliance with the terms of this Development Agreement. The report may be the same report prepared to show compliance with the DDA and TDM Plans and shall include, but not be limited to, compliance with the DDA's infrastructure construction requirements of the Phasing Plan and the Major Alameda Point Amenities and the TDM Compliance Strategy.

**Section 7.3 Effect on Transferees.** If a transfer of the Property or a portion of the Property has been affected by the Developer, the Developer shall be responsible for collecting the



required information from said transferee to prepare a single annual review for the Property.

**Section 7.4 Notice and Cure Rights.** All notice and cure rights shall be as set forth in AMC Section 30-95.

**ARTICLE 8.**  
**AMENDMENTS; TERMINATION; EXTENSION OF TERM**

**Section 8.1 Amendments.** The Development Agreement may be amended by the Parties, upon mutual agreement, consistent with the procedures set forth in Government Code Section 65868 and AMC Section 30-94.3, including any amendments thereto. Except as may otherwise be required by law or court order, all amendments to this Development Agreement, whether approved by the City Council or the City Manager, shall: (i) be in writing; (ii) approved by the City Council in its sole discretion, by ordinance, at a public meeting or alternatively approved by the City Manager pursuant to Section 8(1)(a) below; (iii) signed by both Parties; and (iv) entitled “Development Agreement – Rebuilding the Existing Supportive Housing at Alameda Point (RESHAP), Amendment N” where “N” is the next number in order.

(a) **Ministerial Amendments.** Without further action by the City Council, the City Manager shall have the authority, but not the obligation, to take the following action in his or her sole discretion:

(1) Amend this Development Agreement as necessary to conform to any amendments or modifications to the Town Center Plan, Development Plan or any other Project Approvals approved by the Planning Board and/or City Council subject to the limitations on Future Changes to Applicable Law as set forth in Section 1.2(b) of this Development Agreement;

(2) Amend Article 9 of this Development Agreement as necessary to comply with the requirements of a Mortgagee but only to the extent necessary for Developer to secure needed financing; and so long as such amendments do not materially expose the City to additional risk of liability or subject City to any monetary obligations or damages; and

(3) To consent, on behalf of the City, to a Transfer pursuant to Article 9 herein, and to amend this Development Agreement to correctly identify the new developer.

(b) Nothing in this Section shall be construed as to require the City Manager to exercise his/her discretion or to prevent the City Manager from seeking City Council review and approval of an amendment that might otherwise fall within the City Manager’s authority.

**Section 8.2 Extension Due to Legal Action, Referendum, or Excusable Delay.**

(a) If any litigation is filed challenging this Development Agreement (including but not limited to any CEQA determinations) or the validity of this Development Agreement or any of its provisions, or if this Development Agreement is suspended pending the outcome of an electoral vote on a referendum, then the Term shall be extended for the number of days equal to the period starting from the commencement of the litigation or the suspension to the end of such litigation or suspension. The Parties shall document the start and end of this delay in writing within thirty (30) days from the applicable dates.

(b) In the event of Force Majeure Event, as defined in the DDA, the Parties agree to extend the time periods for performance of Developer's obligations impacted by the Force Majeure. In the event that a Force Majeure Event occurs, the Party claiming the Force Majeure Event shall notify the other Party in writing of such occurrence and the manner in which such occurrence substantially interferes with carrying out the Project or the ability of the Party claiming Force Majeure to perform under this Development Agreement. In the event of the occurrence of any such Force Majeure, the time or times for performance of the obligations of Party claiming Force Majeure will be extended for the period of the delay; provided, however, (i) within thirty (30) days after the beginning of any such delay, the Party claiming Force Majeure shall have first notified the other Party of the cause or causes of such delay and claimed an extension for the reasonably estimated period of the delay; (ii) the Party claiming Force Majeure cannot, through commercially reasonable and diligent efforts, make up for the delay within the time period remaining prior to the applicable completion date; and (iii) under no circumstances may delays for Force Majeure Events cause the term of this Agreement to exceed the Term of the DDA as the DDA may be extended for Force Majeure Events.

(c) In the event that Developer stops any work as a result of a Force Majeure Event as set forth above, Developer must take commercially reasonable measures to ensure that the affected real property is returned to a safe condition and remains in a safe condition.

## **ARTICLE 9.**

### **TRANSFER OR ASSIGNMENT; RELEASE; RIGHTS OF MORTGAGEES**

**Section 9.1 Transfer or Assignment.** Because of the necessity to coordinate development of the entirety of the Property pursuant to the Main Street Neighborhood Specific Plan, particularly with respect to the provision of on- and off-site public improvements and public services, certain restrictions on the right of Developer to assign or transfer its interest under this Development Agreement with respect to the Property, or any portion thereof, are necessary in order to assure the achievement of the goals, objectives and public benefits of the Main Street Neighborhood Specific Plan and this Development Agreement. Developer agrees to and accepts the restrictions set forth in this Article 9 as reasonable and as a material inducement to the City to enter into this Development Agreement.

**Section 9.2 Definition of Transfer.** As used in this Article 9, the term "Transfer" means:

(a) Any total or partial sale, assignment or conveyance, or any trust or power, or any transfer in any other mode of form, of this Agreement or of the Property and/or the Project or any part thereof or any interest therein (including, without limitation, any Sub-Phase) or of the improvements constructed thereon, or any contract or agreement to do any of the same which is not subject to an Estoppel Certificate of Compliance, as defined in the DDA; or

(b) Any total or partial sale, assignment or conveyance, or any trust or power, or any transfer in any other mode or form, of or with respect to any Controlling Interest (defined below) in the Developer, or any contract or agreement to do any of the same. As used herein, the term "**Controlling Interest**" means (1) the ownership (direct or indirect) by one Person of more

than twenty (20%) of the profits, capital, or equity interest of another Person; or (2) the power to direct the affairs or management of another person, whether by contract, other governing documents or operation of Law or otherwise, and Controlled and Controlling have correlative meanings. Common Control means that two persons are both Controlled by the same other person.

**Section 9.3 Prohibited Transfers.** The limitations on Transfers set forth in this Article 9 shall apply with respect to any portion of the Property which is not subject to an Estoppel Certificate of Completion. Except as expressly permitted in this Agreement, the Developer represents and agrees that the Developer has not made or created, and will not make or create or suffer to be made or created, any Transfer, either voluntarily or by operation of law, without the prior approval of the City pursuant to Section 9.5. Any Transfer made in contravention of this Section 9.3 shall be void and shall be deemed to be a default under this Agreement, whether or not the Developer knew of or participated in such Transfer.

**Section 9.4 Permitted Transfers.** Notwithstanding the provisions of Section 9.3, the following Transfers shall be permitted (subject to satisfaction of all applicable conditions to such Transfer):

(a) Any Transfer creating a Security Financing Interest consistent with the Financing Plan, or Phase Update, as applicable, approved by the City pursuant to Section 3.2 of the DDA (as demonstrated to the City's reasonable satisfaction), or otherwise consistent with the provisions of Section 10.1 and 10.2 of the DDA.

(b) Any Transfer directly resulting from the foreclosure of a Security Financing Interest or the granting of a deed in lieu of foreclosure of a Security Financing Interest and if the Permitted Mortgagee is the immediate Transferee pursuant to such foreclosure or deed in lieu, the Permitted Mortgagee's initial Transfer of any portion of the Property to a subsequent Transferee.

(c) Any Transfer consisting of the rental or subletting of a Residential Unit in the normal course of the Developer Affiliate's business operations.

(d) Any Transfer due solely to the death or incapacity of an individual.

(e) Any Transfer to a Developer Affiliate, provided however, any subsequent Transfer by the Developer Affiliate to any other entity other than another Developer Affiliate shall be subject to the restrictions on Transfer set forth in this Article 9.

(f) after Closing, the transfer by the limited partner of a Developer Affiliate of the limited partner's partnership interest to an affiliate of the limited partner provided that either the initial limited partner remains obligated to fund its equity contribution pursuant to the terms of the partnership agreement, or the affiliate assumes the obligations to fund the equity contribution, in accordance with the terms of the partnership agreement (if at the time of the proposed Transfer no equity contribution remains unpaid, then consent shall not be required for the Transfer of the limited partnership interest);

(g) the removal of a general partner of a Developer Affiliate pursuant to the

partnership agreement of the Developer Affiliate and the replacement of such general partner with an affiliate of the limited partner, provided that the admission of a non-affiliate of limited partner shall require the reasonable consent of the City;

(h) Any Transfer of a utility, public right of way, maintenance or access easement reasonably necessary for the development of the Project (each a "Development Easement").

**Section 9.5 Other Transfers In City's Sole Discretion.** Any Transfer not permitted pursuant to an express provision of this Section 9 shall be subject to prior written consent by the City in accordance with this Section 9, which the City may grant or deny in its sole discretion. In connection with such a proposed Transfer, MidPen, the applicable Collaborating Partner or the applicable Developer Affiliate shall first submit to the City information regarding such proposed Transfer, including the proposed documents to effectuate the Transfer, a description of the type of the Transfer, and such other information as would assist the City in considering the proposed Transfer, including where applicable, the proposed transferee's financial strength and the proposed transferee's experience, capacity and expertise with respect to the development, operation and management of affordable housing developments similar to the Project (or applicable portion thereof). The City shall approve or disapprove the proposed Transfer, in its sole discretion, within ninety (90) days of the receipt from MidPen, the applicable Collaborating Partner or the applicable Developer Affiliate all of the information specified above including backup documentation and supplemental information reasonably requested by the City. The City shall specify in writing the basis for any disapproval. If the City should fail to act within such ninety (90) day period the Party requesting the Transfer shall provide the City with written notice of such failure to act which notice shall state in 14-point bold type on the cover page of the notice and on the envelope containing the notice the following:

**FAILURE TO RESPOND TO THIS NOTICE WITHIN TEN (10) BUSINESS DAYS OF THE DATE OF THE NOTICE WILL RESULT IN THE CITY WAIVING ITS RIGHTS TO OBJECT TO THE TRANSFER PROPOSED IN THIS NOTICE.**

If the City fails to respond to the Party requesting the Transfer's notice containing the above language within ten (10) business days of the date of the notice and such notice is delivered to the address and in the manner set forth in Section 15.1 below, the proposed Transfer shall be deemed approved.

**Section 9.6 Effectuation of Permitted or Otherwise Approved Transfers.** Not less than thirty (30) days prior to the intended effectiveness of a Transfer described in this Article 9, the Developer shall deliver to the City a notice of the date of effectiveness of the intended Transfer, a description of the intended Transfer, and such information about the intended Transfer and the transferee as is necessary to enable the City to determine that the intended Transfer meets the standards for a Transfer under this Article 9.

(a) Within five (5) Business Days after the completion of any Transfer permitted pursuant to this Article 9, the Developer shall provide the City with notice of such Transfer.

(b) No Transfer, whether permitted pursuant to Section 9.4 or 9.5 shall be permitted unless, at the time of the Transfer, the person or entity to which such Transfer is made, by an agreement reasonably satisfactory to the City Attorney and in a form recordable among the land records of the County, expressly agrees to perform and observe, from and after the date of the Transfer, the obligations, terms and conditions of the Developer under this Agreement and any ancillary agreements entered into by the Developer pursuant to this Agreement with respect to the portion(s) of the Property and the Project being transferred; provided, however, that no such transferee shall be liable for the failure of its predecessor to perform any such obligation prior to transfer. Anything to the contrary notwithstanding, the holder of a Security Financing Interest whose interest in the Property is acquired by, through or under a Security Financing Interest or is derived immediately from any holder thereof shall not be required to give to the City such written agreement until such holder or other person is in possession of the Property, or applicable portion thereof, or entitled to possession thereof pursuant to enforcement of the Security Financing Interest.

(c) With the regard to all permitted or otherwise approved Transfers in accordance with this Article 9, the City shall provide, within fifteen (15) days of request, a written estoppel to the Developer stating either that Developer has performed any and all obligations required through the date of such Transfer, or, if such is not the case, stating with specificity the obligation(s) which the Developer has failed to perform through the date of such Transfer. In the absence of specific written agreement by the City (which the City may grant or withhold in its sole discretion), no Transfer permitted by this Agreement or approved by the City shall be deemed to relieve the transferor from any obligations under this Agreement.

(d) **Release of Transferring Developer.** Developer shall continue to be obligated under this Development Agreement as to all or the portion of the Property so transferred unless it is a Permitted Transfer or otherwise Approved Transfer as defined in the DDA and/or the City is satisfied the Transferee is fully able to comply with Developer's obligations under this Development Agreement (both financially and otherwise) with respect to the portion of the Property or the Project transferred and Developer is given a release in writing.

### **Section 9.7 Security Financing Interests; Permitted and Prohibited Encumbrances.**

(a) Mortgages, deeds of trust, and other real property security instruments are permitted to be placed upon the Property only as authorized by this Section 9.7. Any security instrument and related interest authorized by this Section 9.7 is referred to as a "Security Financing Interest." Until the applicable Developer Affiliate is entitled to issuance of an Estoppel Certificate of Completion for a particular portion of the Property, the applicable Developer Affiliate may place mortgages, deeds of trust, or other reasonable methods of security on such portion of the Property only for the purpose of securing any approved Security Financing Interest financing of the Vertical Improvements on the applicable portion of the Property.

(b) Following the time the Developer Affiliate is entitled to issuance of an Estoppel Certificate of Completion for a particular portion of the Property, the Developer Affiliate may place any mortgages, deeds of trust, and other real property security interest it desires on that portion of the Property subject to the City Regulatory Agreement.

**Section 9.8 Permitted Mortgagee Not Obligated to Construct.** No Permitted Mortgagee is obligated by, or to perform, any of the Developer Affiliate's obligations under this Agreement, including, without limitation, to construct or complete any improvements or to guarantee such construction or completion; nor shall any covenant or any other provision in conveyances from the City to the Developer Affiliate evidencing the realty comprising the Property or any part thereof be construed so to obligate such Permitted Mortgagee. However, nothing in this Agreement shall be deemed to permit or authorize any Permitted Mortgagee to devote the Property or any portion thereof to any uses, or to construct any improvements thereon, other than those uses or improvements provided for or authorized by this Agreement.

**Section 9.9 Notice of Default and Right to Cure.**

Whenever the City, pursuant to its rights set forth in Article 10, delivers any notice or demand to the Developer Affiliate with respect to the commencement, completion, or cessation of the construction of the Project, the City shall at the same time deliver to each Permitted Mortgagee a copy of such notice or demand. Each such Permitted Mortgagee shall (insofar as the rights of the City are concerned) have the right, but not the obligation, at its option, within thirty (30) days after the receipt of the notice, to cure or remedy or commence to cure or remedy any such default or breach affecting the applicable portion of the Project and to add the cost thereof to the security interest debt and the lien on its security interest. Nothing contained in this Agreement shall be deemed to permit or authorize any Permitted Mortgagee to undertake or continue the construction or completion of the applicable portion of the Project (beyond the extent necessary to conserve or protect such improvements or construction already made) without first having expressly assumed in writing the Developer's obligations to the City relating to the applicable portion of the Project under this Agreement. The Permitted Mortgagee in that event must agree to complete the applicable portion of the Project, in the manner provided in this Agreement. Any Permitted Mortgagee properly completing the applicable portion of the Project pursuant to this Section 10.3 shall assume all applicable rights and obligations of Developer Affiliate under this Agreement and shall be entitled, upon written request made to the City, to an Estoppel Certificate of Completion for the Project or the applicable Phase or Sub-Phase from the City.

**ARTICLE 10.**  
**ENFORCEMENT OF AGREEMENT; REMEDIES FOR DEFAULT; DISPUTE**  
**RESOLUTION**

**Section 10.1 Enforcement.** The only Parties to this Development Agreement are the City and the Developer. This Agreement is not intended and shall not be construed, to benefit or be enforceable by any other person or entity whatsoever.

**Section 10.2 Remedies for Default.**

(a) **Breach.** The failure or delay by either Party to perform any term or provision of this Development Agreement or the DDA shall constitute a breach of this Development Agreement except that the Parties may by mutual consent in writing, or subject to the extensions of time set forth in Section 8.2, extend the time for performance. In the event of alleged breach of any terms or conditions of this Development Agreement, the Party alleging such breach shall give the other Party notice in writing specifying the nature of the breach and the manner in which said breach or default may be satisfactorily cured, and the Party in breach

shall have thirty (30) days following such notice (“**Cure Period**”) to cure such breach, except that in the event of a breach of an obligation to make a payment, the Party in breach shall have ten (10) days to cure the breach. If the breach is of a type that cannot be cured within thirty (30) days, the breaching Party shall, within a thirty (30) day period following notice from the non-breaching Party, notify the non-breaching Party of the time it will take to cure such breach which shall be a reasonable period under the circumstances (“**Extended Cure Period**”); commence to cure such breach; and be proceeding diligently to cure such breach. The Extended Cure Period shall in no event exceed one hundred twenty (120) days unless otherwise agreed by the Parties. During the Cure Period or Extended Cure Period, the Party charged shall not be considered in default for purposes of termination or institution of legal proceedings; but the City's right to refuse to issue a permit or Subsequent Approval, under Section 2.3, shall not be limited by this provision. The failure of any Party to give notice of any breach shall not be deemed to be a waiver of that Party's right to allege that breach or any other breach at any other time.

(b) **Default.** If the breaching Party has not cured such breach within the Cure Period or the Extended Cure Period, if any, such Party shall be in default (“**Default**”), and the non-breaching Party, at its option, may terminate the Development Agreement or institute legal proceedings pursuant to this Development Agreement and shall have such remedies as are set forth in Section 10.3 below.

(1) For purposes of this Development Agreement, and notwithstanding anything to the contrary contained herein, if a Transferee defaults under this Development Agreement, any such default shall not constitute a Developer Default with respect to a portion of the Property not controlled by the Transferee, and shall not entitle the City to terminate or modify this Development Agreement with respect to such other portions of the Property except to the extent that termination is allowed under the DDA.

(c) **Withholding of Permits.** In the event of a Default by Developer, or during an Extended Cure Period, upon a finding by the City Manager that in his or her reasonable opinion, as supported by substantial evidence, Developer is in serious and substantial breach, the City shall have the right to refuse to issue any permits or other approvals to which Developer would otherwise have been entitled pursuant to this Development Agreement. This provision is in addition to and shall not limit any actions that City may take to enforce the conditions of the Project Approvals.

### **Section 10.3 Remedies.**

(a) **Termination by Developer.** The Parties mutually agree pursuant to Government Code Sections 65865.1 and 65868 to the following termination process. In the event of a Default by City, the Developer shall have the right to terminate this Development Agreement upon giving forty-five (45) days prior written notice to City of its intent to terminate.

(b) **Termination by City.** In the event of a Default by the Developer which continues beyond expiration of applicable notice and cure periods, the City, through its City Manager shall have the right to terminate this Development Agreement upon giving forty-five (45) days prior written notice to Developer.

(1) If the City Manager elects to terminate, then within the said 45 days, Developer shall have the right to ask the City Council (during public comment at a City Council meeting) for a hearing to reconsider the termination decision (“**Reconsideration Hearing**”).

(2) The City Council may accept, reject or refuse to respond to a Reconsideration Hearing request in its sole and absolute discretion. If the City Council grants the request for a Reconsideration Hearing, then the matter shall be placed on the City Council’s agenda as soon as practicable but no sooner than fourteen (14) days from the date the request is granted to allow the Developer time to prepare its presentation. If and only if the Reconsideration Hearing is scheduled for (or continued to) a date which is after the effective date of the termination notice, then the effective date of the termination notice is automatically extended until ten (10) days after Reconsideration Hearing date.

(3) The Developer and City staff may, but neither is obligated to, provide the City Clerk with written materials to be included in the agenda packet for the City Council’s review prior to the Reconsideration Hearing. Such materials, if any, must be submitted in time to comply with the City’s Sunshine Ordinance and will become part of the public record.

(4) At the Reconsideration Hearing, the Developer shall have the right to present verbal testimony and written materials to show that: (i) it has cured the Default(s); (ii) that it will cure the Default(s) in the near future if given more time; (iii) that it is willing to offer the City alternative or additional consideration to offset the Default(s); or (iv) that the Development Agreement should not be terminated despite the Default(s).

(5) At the Reconsideration Hearing, City staff may, at its option, present evidence in rebuttal.

(6) After consideration of the materials presented by the Developer and City staff, if any, and following public comment, the City Council may affirm or rescind the termination decision upon any terms or conditions it deems appropriate using its reasonable discretion.

(7) If the City Council conditionally rescinds the termination decision, then the Developer shall have three (3) business days to accept or reject in writing, the conditions stated by the City Council. If the Developer accepts all of the conditions, then the Parties will work together diligently and in good faith to amend this Development Agreement or any other documents necessary to effectuate the new agreement. If the Developer rejects, in whole or in part, the conditions set by the City Council or fails to respond in writing within three (3) business days, then the City Manager’s notice of termination remains in full force and effect and this Development Agreement shall terminate pursuant thereto.

(8) Termination of this Development Agreement shall be subject to the Mortgagee Protection provisions of Article 9 of the Development Agreement.

(c) Additional Remedies.

(1) *Specific Performance; Termination.* In the event of a default under



this Agreement, the remedies available to a Party shall include specific performance of the Agreement in addition to any other remedy available at law or in equity (subject to the limitation on damages set forth in Section 10.3(c)(2)). The City's specific performance remedy shall include the right to require that Developer complete any public or community improvements that Developer has commenced (through exercise of rights under payment and performance bonds or otherwise), and to require dedication of the public improvement to the City upon completion together with the conveyance of real property as contemplated by this Development Agreement and the DDA.

(2) *Limited Damages.* The Parties have determined that except as set forth in this Section 10.3(c)(2), (i) monetary damages are inappropriate and (ii) it would be extremely difficult and impractical to fix or determine the actual damages suffered by a Party as a result of a breach hereunder and (iii) equitable remedies and remedies at law not including damages, but including termination, are particularly appropriate remedies for enforcement of this Agreement. Consequently, the Developer agrees that City shall not be liable to the Developer for damages under this Agreement, and the City agrees that Developer shall not be liable to the City for damages under this Agreement, and each covenants not to sue the other for or claim any damages under this Agreement and expressly waives its right to recover damages under this Agreement, except as follows: (1) the City shall have the right to recover actual damages only and not consequential, punitive or special damages, each of which is hereby expressly waived for (a) Developer's failure to pay sums to City as and when due under this Agreement, but subject to any express conditions for such payment set forth in this Agreement, and (b) Developer's failure to make payment due under any Indemnity in this Agreement, (2) the City shall have the right to recover any and all damages relating to Developer's failure to construct public improvements in accordance with the City approved plans and specifications and in accordance with all applicable laws (but only to the extent that the City first collects against any security, including but not limited to bonds, for such public improvements), and (3) either Party shall have the right to recover attorneys' fees and costs as set forth in Section 10.5, when awarded by an arbitrator or a court with jurisdiction. For purposes of the foregoing, "actual damages" shall mean the actual amount of the sum due and owing under this Agreement or the amount paid under the DDA by Developer, with interest as provided by law, together with such judgment collection activities as may be ordered by the judgment, and no additional sums. .

**Section 10.4 Indemnification.** Developer agrees to defend, indemnify, release and hold harmless the City and its elected and appointed officials and employees from any litigation, claim, action or court proceeding ("**Claim**") brought against any of the foregoing individuals or entities (the "**Indemnified Parties**"), arising out of or in connection with the approval or enforcement of this Development Agreement, or arising out of or in connection with any City approvals for the Site A Project, including the environmental review process or other approval under federal, state or City codes, statutes, codes, regulations, or requirements, and any combination thereof relating to the Project or any portion thereof ("**Third-Party Challenge**"). This indemnification shall include, without limitation, reasonable fees of attorneys, consultants and experts and related costs, and the City's costs of investigating any Claims against the Indemnified Parties. Developer shall reimburse the City for its actual costs in defense of the action or proceeding, including but not limited to the time and expenses of the City Attorney's Office and any consultants as such costs are incurred and bills transmitted; provided, however, (i) Developer shall have the right to monthly invoices for all such costs, and (ii) Developer may elect to terminate this Development

Agreement, and upon any such termination, Developer's and City's obligations to defend the Third-Party Challenge shall cease and Developer shall have no responsibility to reimburse any City defense costs incurred after such termination date. If this Agreement is the subject of a third party challenge and Developer fails to comply with the requirements of this section with regards to the payment of the City's attorneys' fees or other costs associated with such third party challenge, the City shall have no obligation to defend the Agreement from such third party challenge. Notwithstanding the foregoing, in no event shall Developer be obligated to indemnify any Indemnified Party to the extent any Claim is the result of the gross negligence or willful misconduct of an Indemnified Party.

**Section 10.5 Attorney's Fees.** If legal action is brought by either Party against the other for default under this Development Agreement or to enforce any provision herein, the prevailing party is entitled to recover its reasonable attorney's fees, expert witness fees, and court costs.

**Section 10.6 Provisions that Survive Termination of this Development Agreement.** It is expressly agreed by the Parties that the following provisions survive the termination or expiration of this Development Agreement:

- (a) Section 5.3 – Cooperation in the Event of Third Party Challenge
- (b) Section 10.3 – Remedies
- (c) Section 10.4 – Indemnification
- (d) Section 10.5 – Attorney's Fees

## **ARTICLE 11.** **MISCELLANEOUS PROVISIONS**

**Section 11.1 Entire Agreement.** This Development Agreement, including the preamble paragraphs, Recitals and Exhibits, constitute the entire understanding and agreement between the Parties with respect to the subject matter contained herein.

**Section 11.2 Severability.** If any term, provision or condition of this Development Agreement, or the application of any term, provision or condition of this Development Agreement to a set of facts or circumstances is held by a court of competent jurisdiction to be invalid, void or unenforceable, the remaining terms, provisions and conditions of this Development Agreement and its application shall continue in full force and effect unless the remaining portions of the Development Agreement would be unreasonable or grossly inequitable under all circumstances or would frustrate the purpose of this Agreement.

**Section 11.3 Applicable Law and Venue.** This Development Agreement shall be interpreted, construed and enforced with the laws of the State of California. All rights and obligations of the Parties under this Development Agreement are to be performed in the City of Alameda in the County of Alameda and such city and county shall be the venue for any legal action or proceeding that may arise out of or be brought in connection with or by reason of this Development Agreement.

**Section 11.4 Time of the Essence.** Time is of the essence in this Development Agreement. All reference to days shall mean calendar days unless otherwise noted. All reference to year shall mean fiscal year unless otherwise noted.

**Section 11.5 Binding Upon Successors; Covenants to Run With Land.** This Development Agreement shall be binding upon and inure to the benefit of the heirs, administrators, executors, successors in interest, and assigns of each of the Parties, and the terms of this Agreement shall constitute covenants running with the land; provided, however, that there shall be no Transfer by the Developer except as permitted in Article 9. Any reference in this Agreement to a specifically named Party shall be deemed to apply to any heir, administrator, executor, successor in interest, or assign of such Party who has acquired an interest in compliance with the terms of this Agreement or under law.

**Section 11.6 Parties Not Co-Venturers.** Nothing in this Agreement is intended to or does establish the Parties as partners, co-venturers, or principal and agent with one another. The City has not provided any financial assistance in connection with this Development Agreement or the Project, this Development Agreement constitutes an arms-length transaction and the City has not provided any other subsidies, fee waivers, or other special treatment.

**Section 11.7 Title of Parts and Sections.** Any titles of the Sections or subsections of this Development Agreement are inserted for convenience of reference only and shall be disregarded in interpreting any of its provisions.

**Section 11.8 Successors and Assigns.** Subject to the provisions of Article 9 relating to Transfer, the terms, covenants and conditions contained in this Development Agreement shall bind and inure to the benefit of City, Developer and their respective successors and assigns; provided, however, that the City shall have no obligation under this Development Agreement to, nor shall any benefit of this Development Agreement accrue to, any unapproved successor or assign of Developer where City approval of a successor or assign is required by this Development Agreement.

**Section 11.9 Cooperative Drafting.** This Development Agreement has been drafted through a cooperative effort of both Parties, and both Parties have had an opportunity to have the Development Agreement reviewed and revised by legal counsel of their own choosing. No Party shall be considered the drafter of this Development Agreement, and no presumption or rule that an ambiguity shall be construed against the Party drafting the clause shall apply to the interpretation or enforcement of this Development Agreement.

**Section 11.10 Integration.** This Development Agreement consists of thirty-two (32) pages and four (4) Exhibits which constitute in full, the final and exclusive understanding and agreement of the Parties and supersedes all negotiations or previous agreements of the Parties with respect to all or any part of the subject matter hereof. All waivers of the provisions of this Development Agreement shall be in writing and signed by the appropriate authorities of the City and the Developer.

**Section 11.11 No Third Party Beneficiaries.** There are no third party beneficiaries to this Development Agreement.

**Section 11.12 Non-Liability of Officials, Employees and Agents.** No City elected or appointed official, board member, commission, officer, employee, attorney, agent, volunteer or their respective successors and assigns shall be personally liable to the Developer, or any successor in interest, in the event of a City Event of Default.

**Section 11.13 Signature in Counterparts.** This Development Agreement may be executed in duplicate counterpart originals, each of which is deemed to be an original, and all of which when taken together shall constitute one and the same instrument.

**Section 11.14 Notices and Communications.**

(a) Method. Any notice or communication required hereunder to be given by the City or the Developer shall be in writing and shall be delivered by each of the following methods: (1) electronically (e.g., by e-mail delivery); and (2) either personally, by reputable overnight courier, or by registered or certified mail with a return receipt request. Notwithstanding the time of any electronic delivery, the notice or communication shall be deemed delivered as follows:

(1) If delivered by registered or certified mail, the notice or communication shall be deemed to have been given and received on the first to occur of: (A) actual receipt by any of the addressees designated below as a party to whom notices are to be sent; or (B) five (5) days after the registered or certified letter containing such notice, properly addressed, with postage prepaid, is deposited in the United States mail. If delivered personally or by overnight courier, a notice or communication shall be deemed to have been given when delivered to the Party to whom it is addressed.

(2) Either Party may at any time, by giving ten (10) days' prior written notice to the other Party pursuant to this section, designate any other address in substitution of the address to which such notice or communication shall be given.

(b) Addresses. The address of each party for the purpose of all notices permitted or required by this Development Agreement is as follows:

*To City:* City of Alameda  
Alameda City Hall, Rm 320  
2263 Santa Clara Avenue  
Alameda, CA 94501  
Attn: City Manager  
Telephone: 510-747-4700  
Facsimile: 510-865-1498  
Email: lwarmerdam@alamedaca.gov

With a copy to: City of Alameda  
Alameda City Hall, Rm 280  
2263 Santa Clara Avenue  
Alameda, CA 94501  
Attn: City Attorney  
Telephone: 510-747-4752  
Facsimile: 510-865-4028  
Email: jkern@alamedacityattorney.org

If to Developer to: MidPen Housing Corporation  
303 Vintage Park Drive, Suite 250  
Foster City, CA 94404  
Attention: President  
Telephone: 650-356-2900  
Fax Number: 650-357-9766

With copies to: Alameda Point Collaborative  
677 W. Ranger Avenue  
Alameda, CA 94501  
Attn: Executive Director  
Telephone: 510-898-7800

With copies to: Building Futures With Women and Children  
1395 Bancroft Avenue  
San Leandro, CA 94577  
Attn: Executive Director  
Telephone: 510-357-0205

With copies to: Operation Dignity  
3850 San Pablo Avenue, Suite 102  
Emeryville, CA 94608  
Attn: Executive Director  
Telephone: 800-686-9036

(c) Special Requirement. If failure to respond to a specified notice, request, or other communication within a specified period would result in a deemed approval, a conclusive presumption, a prohibition against further action or protest, or other adverse result under this Development Agreement, the notice, request or other communication shall state clearly and unambiguously on the first page, with reference to the applicable provisions of this Agreement, that failure to respond in a timely manner could have a specified adverse result.

**[Remainder of Page Intentionally Left Blank]**

In WITNESS WHEREOF, the Parties have signed this Disposition and Development Agreement on the dates indicated below.

**CITY OF ALAMEDA**

By: \_\_\_\_\_  
Elizabeth Warmerdam  
Acting City Manager

Date: \_\_\_\_\_

**Attest:            Recommended for Approval:**

\_\_\_\_\_  
Lara Weisiger, City Clerk

\_\_\_\_\_  
Jennifer Ott, Director  
Base Reuse and Transportation Planning  
Department

**Approved as to Form:**

\_\_\_\_\_  
Andrico Q. Penick  
Chief Real Estate Counsel

Authorized by City Council Ordinance No. \_\_\_\_\_

*Signatures continue on next page*

**MidPen Housing Corporation**, a California nonprofit public benefit corporation

By: \_\_\_\_\_

Name: \_\_\_\_\_

Title: \_\_\_\_\_

**Alameda Point Collaborative**, a California nonprofit public benefit corporation

By: \_\_\_\_\_

Name: \_\_\_\_\_

Title: \_\_\_\_\_

**Building Futures with Women and Children**, a California nonprofit public benefit corporation

By: \_\_\_\_\_

Name: \_\_\_\_\_

Title: \_\_\_\_\_

**Operation Dignity**, a California nonprofit public benefit corporation

By: \_\_\_\_\_

Name: \_\_\_\_\_

Title: \_\_\_\_\_

Authorized by City Council Ordinance No. \_\_\_\_\_

**Exhibits:**

- A Property Legal Description**
- B Development Plan**
- C List of Impact Fees**
- D Initial Phasing Plan**

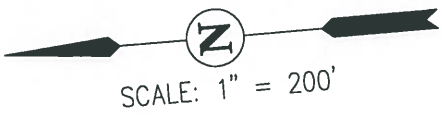

EXHIBIT A

LEGAL DESCRIPTION OF THE PROPERTY

The Property referred to in the Agreement to which this Exhibit A is attached is situated in the State of California, Alameda County, City of Alameda and is described as follows:

PARCEL ONE  
 AGREED NON-TRUST LANDS  
 DN. 2014-154597



LINE TABLE		
NO	BEARING	LENGTH
L1	N04°47'18"E	25.08'

CURVE TABLE			
NO	RADIUS	DELTA	LENGTH
C1	610.00'	22°08'09"	235.67'
C2	725.00'	22°29'24"	284.58'
C3	20.00'	90°00'00"	31.42'
C4	20.00'	85°46'27"	29.94'

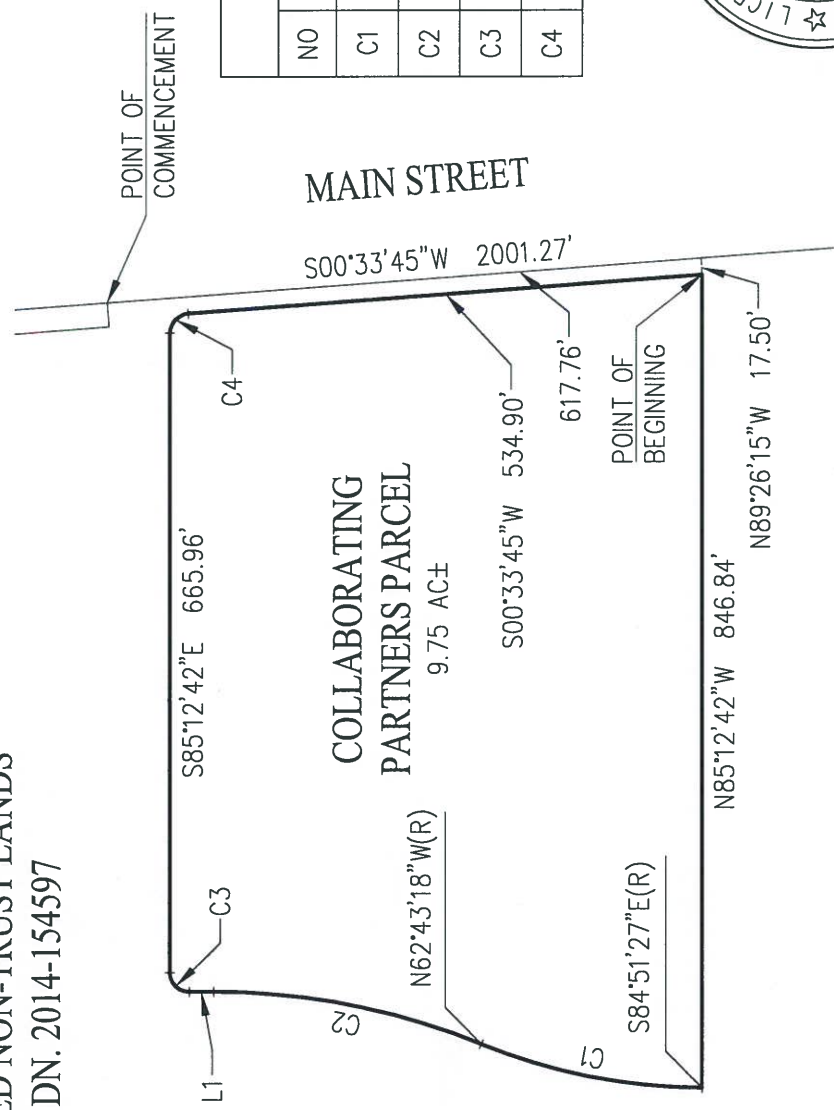

SHEET 1 OF 1

PLAT TO ACCOMPANY LEGAL DESCRIPTION

COLLABORATING PARTNERS PARCEL  
 ALAMEDA POINT  
 ALAMEDA, CALIFORNIA  
 JANUARY 3, 2018

**Carlson, Barbee & Gibson, Inc.**

CIVIL ENGINEERS • SURVEYORS • PLANNERS  
 WWW.CBandG.COM

SAN RAMON • (925) 866-0322  
 WEST SACRAMENTO • (916) 375-1877

JANUARY 3, 2018  
JOB NO.: 1087-010

LEGAL DESCRIPTION  
COLLABORATING PARTNERS PARCEL  
ALAMEDA POINT  
ALAMEDA, CALIFORNIA

REAL PROPERTY, SITUATE IN THE INCORPORATED TERRITORY OF THE CITY OF ALAMEDA, COUNTY OF ALAMEDA, STATE OF CALIFORNIA, DESCRIBED AS FOLLOWS:

BEING A PORTION OF THAT CERTAIN PARCEL OF LAND DESCRIBED AS PARCEL ONE OF THE PHASE 1 AGREED NON-TRUST LANDS, AS SAID PARCEL ONE IS DESCRIBED IN THAT CERTAIN PATENT DEED RECORDED JUNE 30, 2014, AS DOCUMENT NO. 2014154597 OF OFFICIAL RECORDS, IN THE OFFICE OF THE COUNTY RECORDER OF ALAMEDA COUNTY, MORE PARTICULARLY DESCRIBED AS FOLLOWS:

COMMENCING AT A POINT ON THE EASTERN LINE OF SAID PARCEL ONE, SAID POINT BEING THE NORTHERN TERMINUS OF THAT CERTAIN COURSE DESCRIBED AS, "SOUTH 00°33'45" WEST 2,001.27 FEET", ON PAGE 10 OF 27 OF SAID DEED (DN 2014154597);

THENCE, FROM SAID POINT OF COMMENCEMENT, ALONG SAID EASTERN LINE, SOUTH 00°33'45" EAST 617.76 FEET;

THENCE, LEAVING SAID EASTERN LINE, NORTH 89°26'15" WEST 17.50 FEET TO THE POINT OF BEGINNING FOR THIS DESCRIPTION;

THENCE, FROM SAID POINT OF BEGINNING, NORTH 85°12'42" WEST 846.84 FEET;

THENCE, ALONG THE ARC OF A NON-TANGENT 610.00 FOOT RADIUS CURVE TO THE RIGHT, FROM WHICH THE CENTER OF SAID CURVE BEARS SOUTH 84°51'27" EAST, THROUGH A CENTRAL ANGLE OF 22°08'09", AN ARC DISTANCE OF 235.67 FEET;

THENCE, ALONG THE ARC OF A REVERSE 725.00 FOOT RADIUS CURVE TO THE LEFT, FROM WHICH THE CENTER OF SAID CURVE BEARS NORTH 62°43'18" WEST, THROUGH A CENTRAL ANGLE OF 22°29'24", AN ARC DISTANCE OF 284.58 FEET;

THENCE, NORTH 04°47'18" EAST 25.08 FEET;

THENCE, ALONG THE ARC OF A TANGENT 20.00 FOOT RADIUS CURVE TO THE RIGHT, THROUGH A CENTRAL ANGLE OF 90°00'00", AN ARC DISTANCE OF 31.42 FEET;

THENCE, SOUTH 85°12'42" EAST 665.96 FEET;

THENCE, ALONG THE ARC OF A TANGENT 20.00 FOOT RADIUS CURVE TO THE RIGHT, THROUGH A CENTRAL ANGLE OF 85°46'27", AN ARC DISTANCE OF 29.94 FEET;

THENCE, SOUTH 00°33'45" WEST 534.90 FEET TO SAID POINT OF BEGINNING.  
CONTAINING 9.75 ACRES OF LAND, MORE OR LESS.

ATTACHED HERETO IS A PLAT TO ACCOMPANY LEGAL DESCRIPTION, AND BY THIS REFERENCE MADE A PART HEREOF.

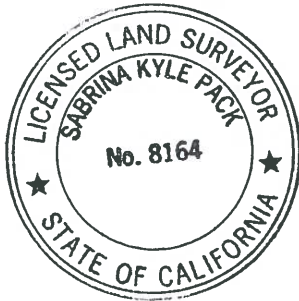

END OF DESCRIPTION

A handwritten signature in blue ink, appearing to read "S. Kyle Pack", written over a horizontal line.

SABRINA KYLE PACK, P.L.S.  
L.S. NO. 8164

FOR ASSESSMENT PURPOSES ONLY. THIS DESCRIPTION OF LAND IS NOT A LEGAL PROPERTY DESCRIPTION AS DEFINED IN THE SUBDIVISION MAP ACT AND MAY NOT BE USED AS THE BASIS FOR AN OFFER OF SALE OF THE LAND DESCRIBED.

EXHIBIT B

DEVELOPMENT PLAN

# REBUILDING THE EXISTING SUPPORTIVE HOUSING AT ALAMEDA POINT (RESHAP) - DEVELOPMENT PLAN

---

**Project Sponsors: Alameda Point Collaborative, Building Futures, Operation Dignity, and MidPen Housing Corporation  
(Collaborating Partners)**

**Prepared by: David Baker Architects**

**September 25, 2017**

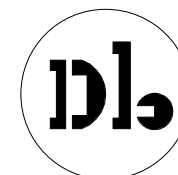

# RESHAP DEVELOPMENT PLAN - TABLE OF CONTENTS

---

## CONTEXT

History of Providing Supportive Housing	03
Existing Supportive Housing	04
Community Outreach & Feedback	05
Existing RESHAP Site Conditions	06
Existing RESHAP Site Photos	07

## LAND USE & DEVELOPMENT

Illustrative Site Plan - All Phases	08
Illustrative Site Plan - Phasing	09
Land Use Diagram	10
Open Space Diagram	11
Ground Floor Plan	12
Affordable Housing Plan	13
Aerial Massing View Looking South	14
Aerial Massing View Looking North	15
Collaborating Partners Community Intersection	16
Collaborating Partners Plaza and Barn	17
Character Images	
High Quality Housing	18
Dynamic Open Spaces	19
Cultivating Community	20
Enhancing the Urban Agriculture	21

## CIRCULATION & OPEN SPACE

Internal Streets	22
Shared Streets	23
Proposed Vehicular Access	24
Bicycle & Transit Facilities	25
Parking & Bicycle Parking Plan	26
Bay Friendly Planting	27
Preliminary Stormwater Management Plan	28-29



RESHAP

CONTENTS

scale: 21510  
date: 2017.09.11



**A Shared Vision to End Homelessness**

Alameda Point Collaborative (APC), Building Futures (BFWC), and Operation Dignity (OD) are partnering with MidPen to design, construct, own and operate new high quality housing at Alameda Point. RESHAP will create a cohesive community providing high quality and stable housing with enhanced services for the residents while also re-energizing the Main Street Neighborhood. Each partner brings specialized and complementary skills and experience to RESHAP.

APC was formed in 1999 to help families and individuals break the cycle of homelessness and poverty. APC now provides over 350 formerly homeless residents, including 200 children and youth, with the safety and stability of a place to call home. All residents will continue to have access to life and job skills training and substance abuse and mental health counseling provided by a team of highly skilled professionals.



BFWC was founded in 1988 and provides a continuum of care, resources, programs, and services to help Alameda County residents build futures free from homelessness and family violence. BFWC currently provides 52 units of permanent housing at Bessie Coleman Court located at Alameda Point. Services provided to the community include a 24-hour crisis line, a domestic violence outreach program providing support groups, and individual support and resources.

OD was founded in 1993 and assists homeless veterans and their families by providing emergency, transitional, and permanent housing and mobile outreach for homeless veterans in Alameda County. At Alameda Point, OD currently provides a mix of permanent supportive housing and transitional housing in 28 units at Dignity Commons. OD offers housing and employment search support, nutritious meals, veteran peer support, assistance accessing VA and other benefits, and connections to physical and mental health care.

**Providing Housing for Veterans, Formerly Homeless Families, and Survivors of Domestic Violence**

Alameda Point Collaborative (APC), Building Futures (BFWC), and Operation Dignity (OD) currently lease 34 acres of land at the former Naval Air Station from the City, pursuant to terms of long term legally binding agreements by rights conveyed through the Base Realignment and Closure Act. The three organizations utilize the aging Navy structures to collectively provide affordable housing and supportive services to over 500 formerly homeless residents. Together, they provide job skills training, mental health counseling, access to nutritious meals, opportunities for social enterprise, and opportunities to break the cycle of homelessness.

MidPen was founded in 1970 to address concerns over the lack of affordable housing in the San Francisco Bay Area. As one of the largest developers and owners of high-quality affordable rental housing in Northern California, MidPen has developed or rehabbed over 8,000 affordable homes and has provided housing solutions for low-income working families, seniors, and individuals with special needs. MidPen builds and manages properties to be long-term community assets.

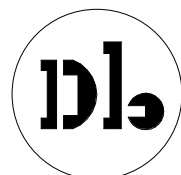

**RESHAP**

**HISTORY OF PROVIDING SUPPORTIVE HOUSING**

21510  
scale:  
date: 2017.09.11



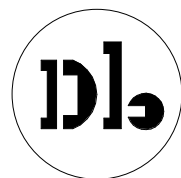
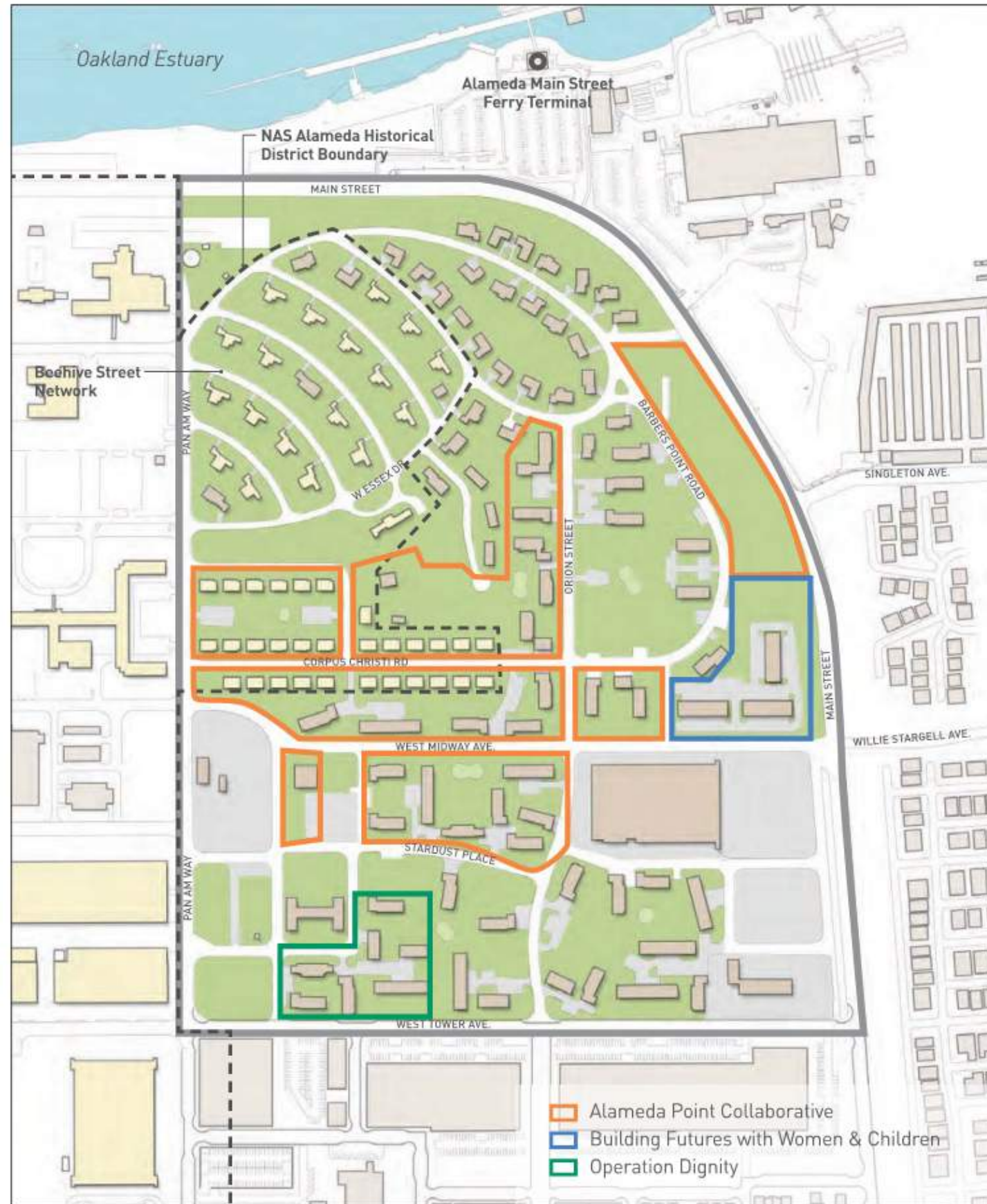

RESHAP

EXISTING SUPPORTIVE HOUSING

scale: 21510  
date: 2017.09.11



Throughout the summer and fall of 2015, the Collaborating Partners and David Baker Architects created and implemented a highly collaborative resident engagement process before developing the site plan. With nearly 500 residents living at the existing housing, the Collaborating Partners recognized the community's value in being an integral part of the planning process. Engagement opportunities included: community-wide design input meetings, monthly meetings with each provider's residents, focus groups with Collaborating Partners' staff, 1-on-1 interviews and other meetings as needed



Over 100 residents participated in each of the community-wide design meetings. The Collaborating Partners received over 600 comments regarding the housing types, indoor amenities, outdoor amenities, and site circulation. Common feedback we received included:

- Desire for variety of housing types to meet needs for family size, security, and accessibility
- Multi-purpose community spaces
- Street lighting
- Priority for people and bikes
- Outdoor seating, play areas, street trees

This invaluable feedback is reflected in the proposed RESHAP Development Plan's site, buildings, and open spaces.

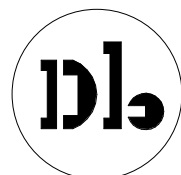

**RESHAP**

**COMMUNITY OUTREACH & FEEDBACK**

21510

scale:  
date: 2017.09.11



Google Earth

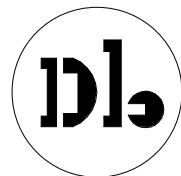

RESHAP

PROPOSED RESHAP SITE

scale: 21510  
date: 2017.09.11

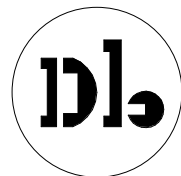

RESHAP

## EXISTING RESHAP SITE PHOTOS

scale: 21510  
date: 2017.09.11



**LEGEND**

-  3 STORY APARTMENTS - ALAMEDA POINT COLLABORATIVE [68 DWELLINGS]
-  3 STORY APARTMENTS - OPERATION DIGNITY [72 DWELLINGS]
-  3 STORY APARTMENTS - BUILDING FUTURES [52 DWELLINGS]
-  MIXED-USE / COMMERCIAL BUILDINGS [32 DWELLINGS]
-  2 STORY TOWNHOMES - ALAMEDA POINT COLLABORATIVE [43 DWELLINGS]
-  SUPPORTIVE SERVICES SPACES
-  2 STORY BARN / COMMUNITY CENTER
-  PLAY AREA

RESHAP Illustrative Site Plan  
1" = 100'-0"

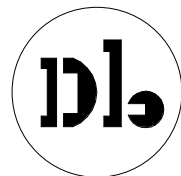

**RESHAP**

**ILLUSTRATIVE PLAN - ALL PHASES**

21510  
scale: As indicated  
date: 2017.09.11



ILLUSTRATIVE SITE PLAN - PHASE 1



ILLUSTRATIVE SITE PLAN - PHASE 2



ILLUSTRATIVE SITE PLAN - PHASE 3



ILLUSTRATIVE SITE PLAN - PHASE 4

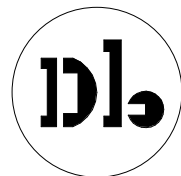

RESHAP

ILLUSTRATIVE SITE PLAN - PHASING

21510  
 scale: 1" = 200'-0"  
 date: 2017.09.11

**LEGEND**

- MIXED USE / COMMERCIAL +25' HEIGHT
- RESIDENTIAL APARTMENT +35' HEIGHT
- TOWNHOME +30' HEIGHT
- SHELTER +15' HEIGHT
- RESIDENT SERVICES
- COMMUNITY SPACE +18' HEIGHT
- OPEN SPACE - NEIGHBORHOOD
- OPEN SPACE - RESIDENTS
- PARKING

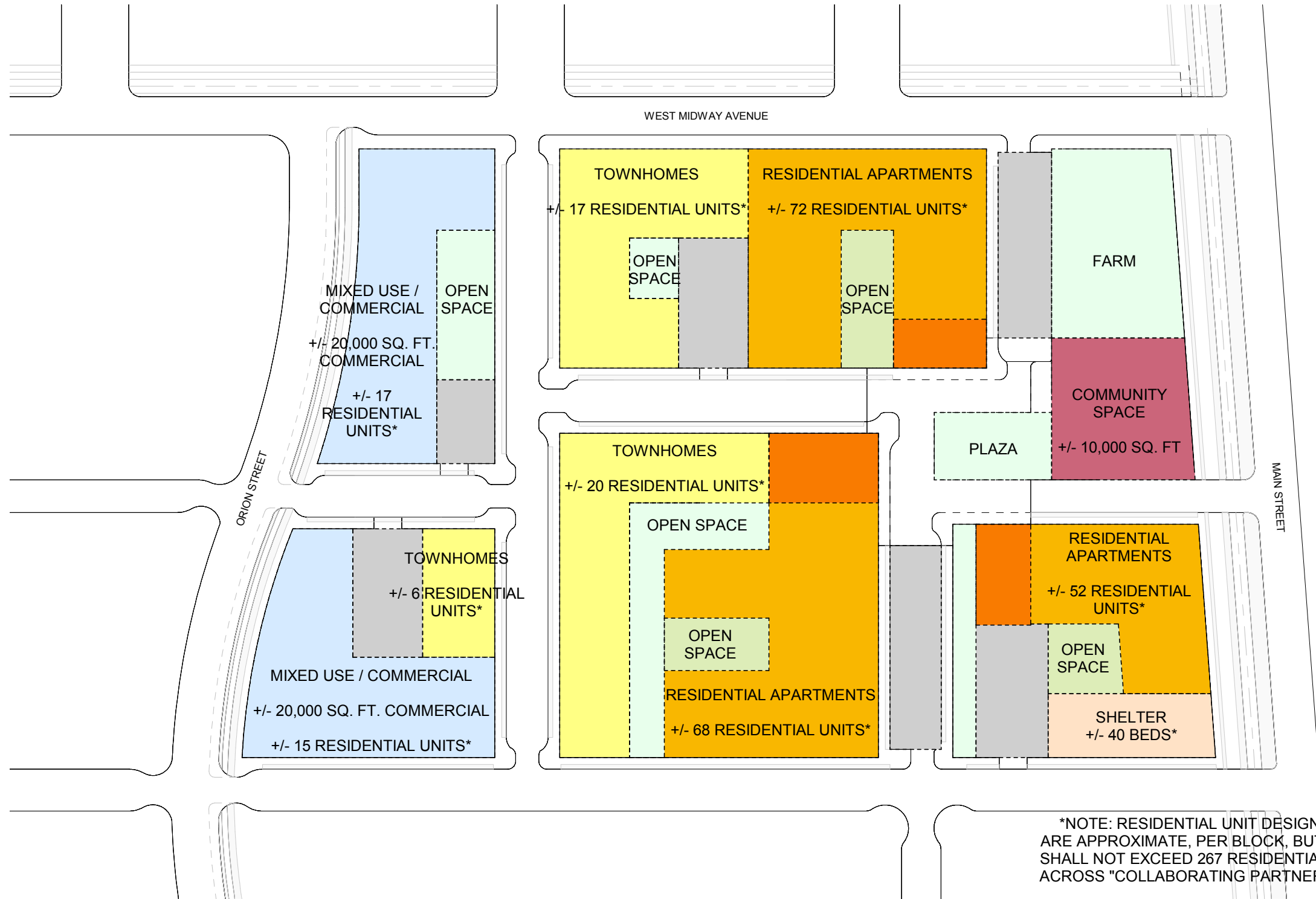

\*NOTE: RESIDENTIAL UNIT DESIGNATIONS ARE APPROXIMATE, PER BLOCK, BUT TOTAL SHALL NOT EXCEED 267 RESIDENTIAL UNITS ACROSS "COLLABORATING PARTNERS SITE"

Site Plan - Land Use  
1" = 100'-0"

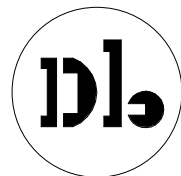

**RESHAP**

**LANDUSE DIAGRAM**

21510  
scale: As indicated  
date: 2017.09.11



**LEGEND**

- PRIVATE PARK / PASSAGE
- PRIVATE PLAZA
- PRIVATE COURTYARD
- FARM

Site Plan - Open Space  
1" = 100'-0"

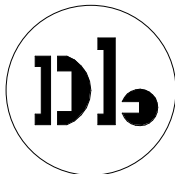

**RESHAP**

**OPEN SPACE DIAGRAM**

21510  
scale: As indicated  
date: 2017.09.11



**LEGEND**

- MIXED USE / COMMERCIAL +25' HEIGHT
- RESIDENTIAL APARTMENT +35' HEIGHT
- TOWNHOME +30' HEIGHT
- SHELTER +15' HEIGHT
- RESIDENT SERVICES
- COMMUNITY SPACE +18' HEIGHT
- OPEN SPACE - NEIGHBORHOOD
- OPEN SPACE - RESIDENTS
- PARKING

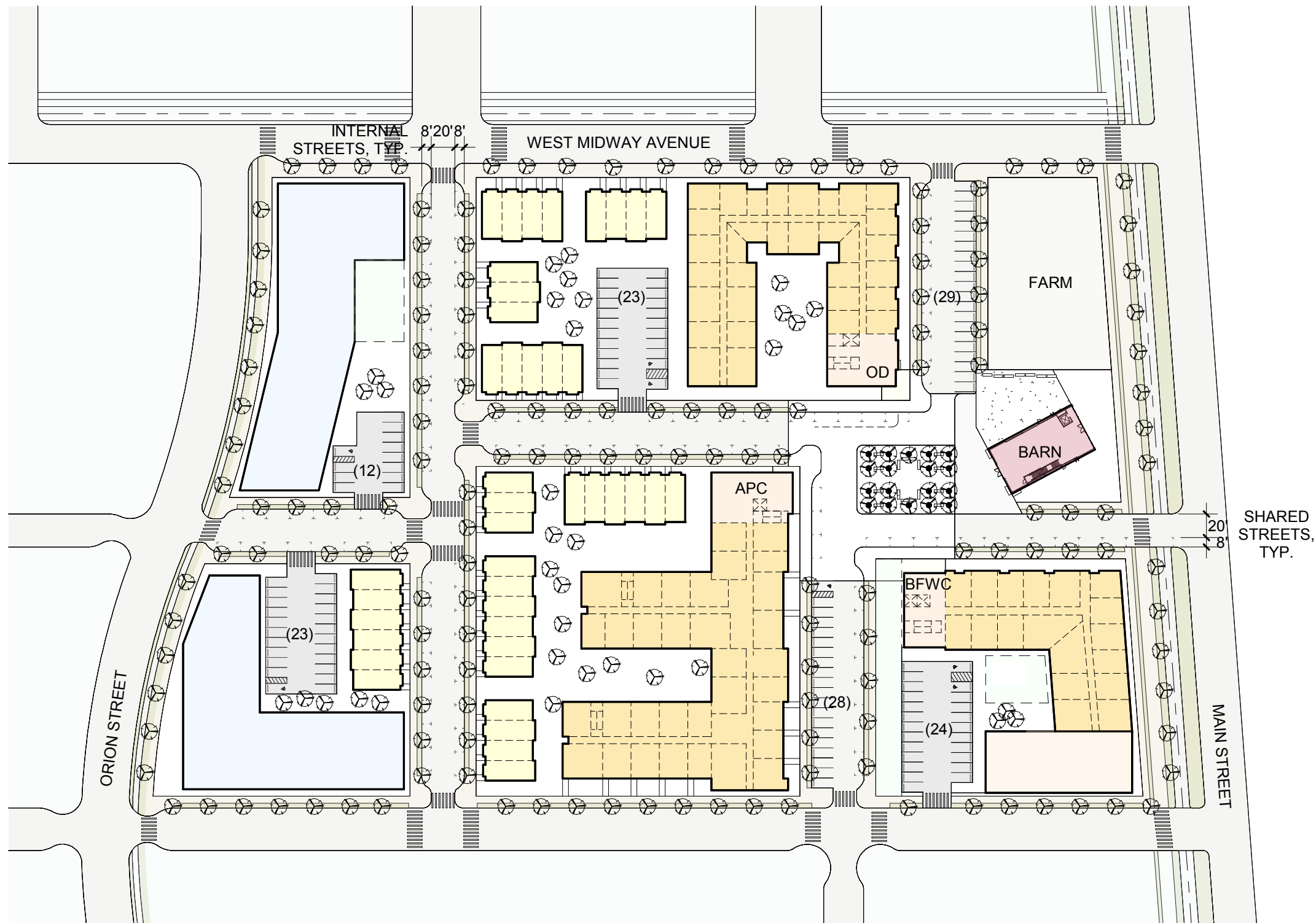

Ground Floor Plan  
1" = 100'-0"

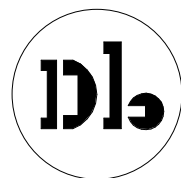

**RESHAP**

**GROUND FLOOR PLAN**

21510  
scale: As indicated  
date: 2017.09.11

**100% AFFORDABLE**

**LEGEND**

- MIXED USE / COMMERCIAL +25' HEIGHT
- RESIDENTIAL APARTMENT +35' HEIGHT
- TOWNHOME +30' HEIGHT
- SHELTER +15' HEIGHT
- RESIDENT SERVICES
- COMMUNITY SPACE +18' HEIGHT
- OPEN SPACE - NEIGHBORHOOD
- OPEN SPACE - RESIDENTS
- PARKING

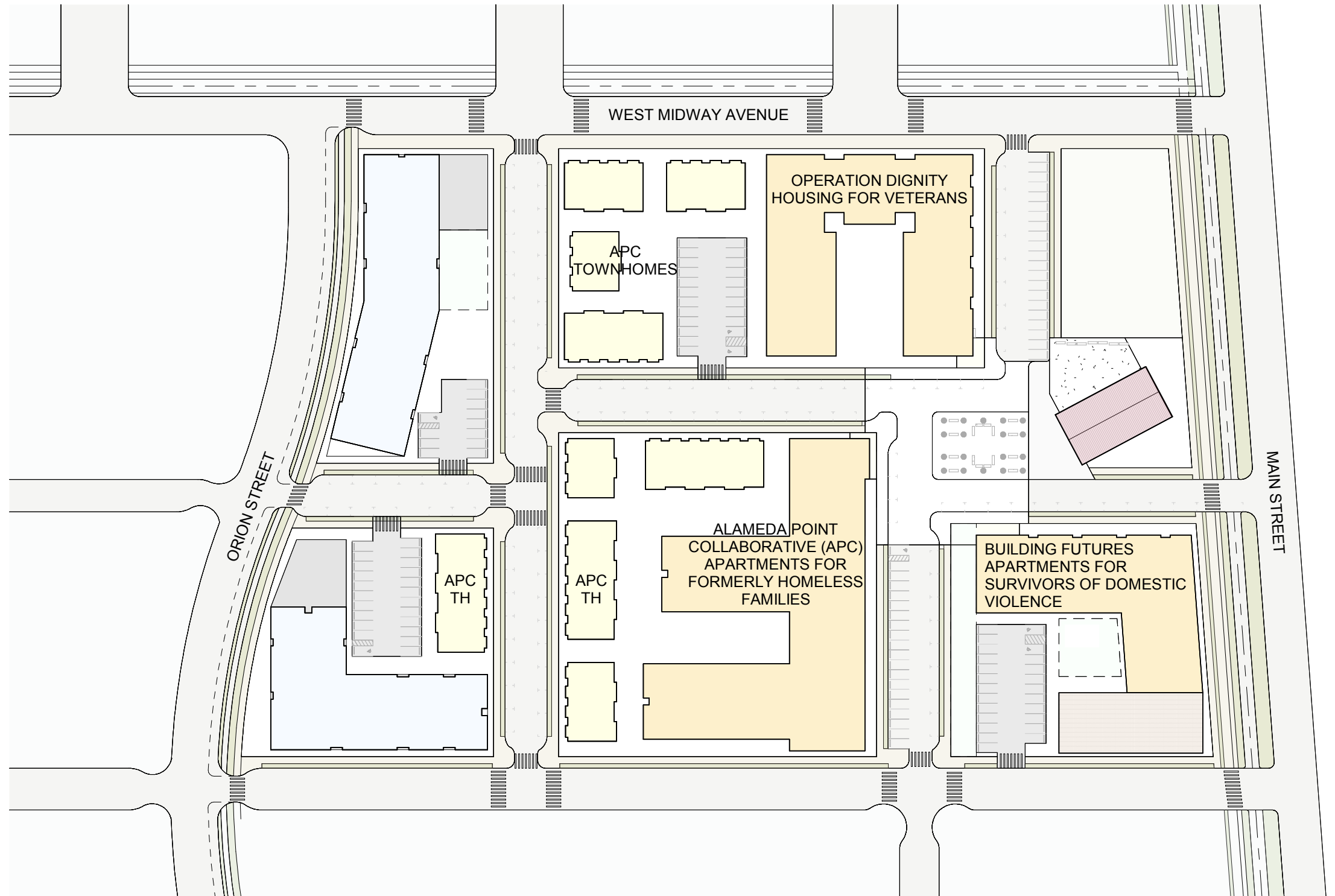

Affordable Housing Plan  
1" = 100'-0"

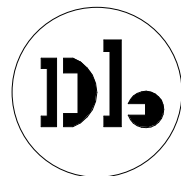

**RESHAP**

**AFFORDABLE HOUSING PLAN**

21510  
scale: As indicated  
date: 2017.09.11

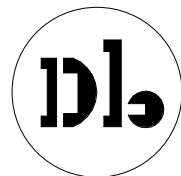

RESHAP

AERIAL MASSING LOOKING SOUTH

21510  
scale:  
date: 2017.09.11

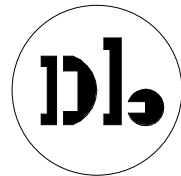

RESHAP

AERIAL MASSING LOOKING NORTH

21510  
scale:  
date: 2017.09.11

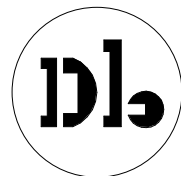

**RESHAP**

**COLLABORATING PARTNERS  
COMMUNITY PLAZA INTERSECTION**

scale: 21510  
date: 2017.09.11

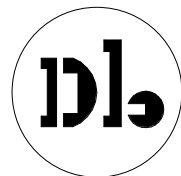

RESHAP

## COLLABORATING PARTNERS PLAZA AND BARN

scale: 21510  
date: 2017.09.11



# LIVING IN DIGNITY AND HIGH QUALITY HOUSING

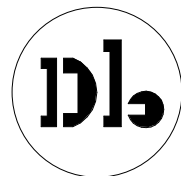

RESHAP

CHARACTER IMAGES

scale: 21510  
date: 2017.09.11



# DYNAMIC OPEN SPACES TO BUILD COMMUNITY

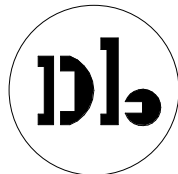

RESHAP

CHARACTER IMAGES

21510  
scale:  
date: 2017.09.11



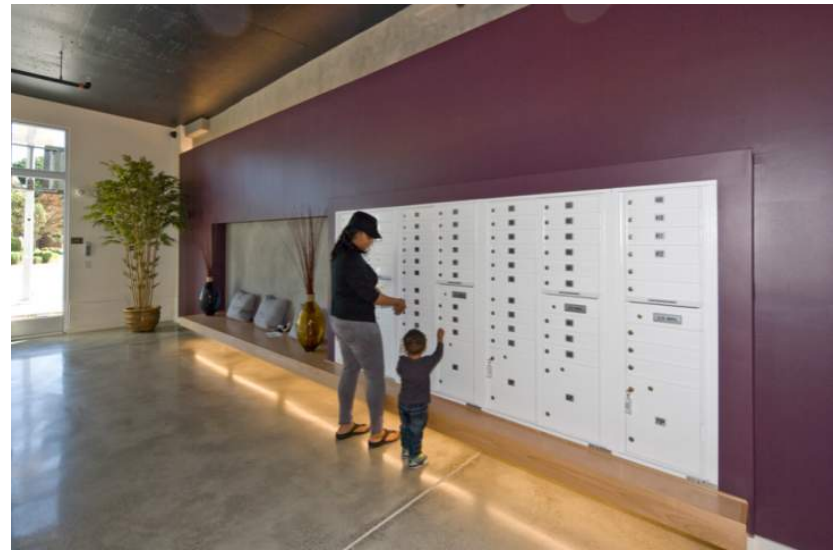

CULTIVATING  
COMMUNITY WITH  
ACTIVITIES &  
OPPORTUNITIES  
TO SOCIALIZE

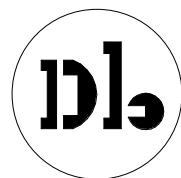

RESHAP

CHARACTER IMAGES

21510  
scale:  
date: 2017.09.11



PROVIDING JOB OPPORTUNITIES  
WHILE ENHANCING THE URBAN  
AGRICULTURE CHARACTER OF THE  
MAIN STREET NEIGHBORHOOD

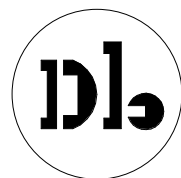

RESHAP

CHARACTER IMAGES

21510  
scale: 1" = 100'-0"  
date: 2017.09.11

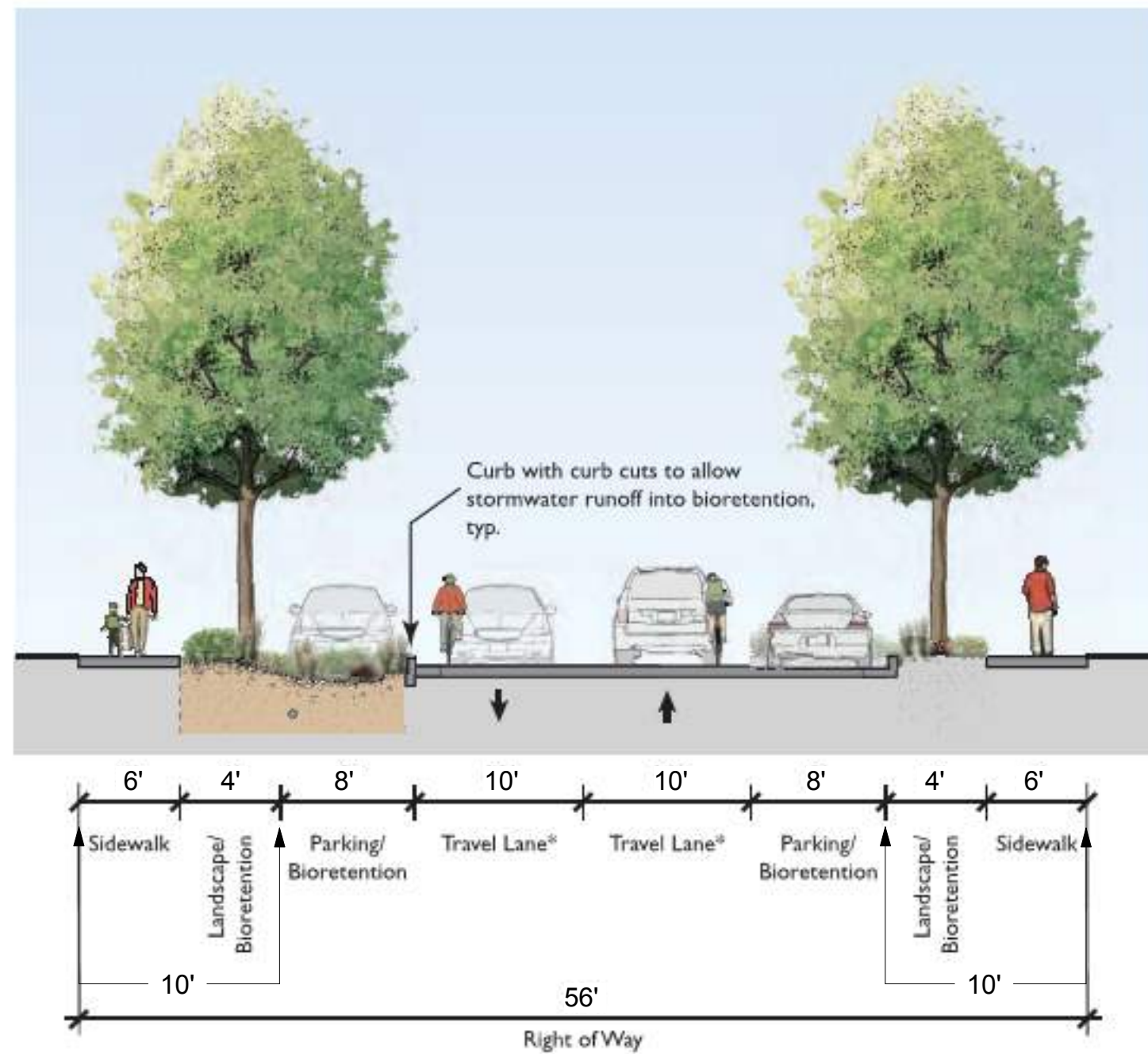

\* Follows Main Street Neighborhood Specific Plan, Fig. 3-14 Local Street, with the exception of Landscape/Bioretenion deviation from 6' to 4' to promote smaller scale and more walkable neighborhood streets within the RESHAP site.

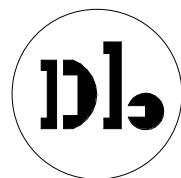

RESHAP

INTERNAL STREETS

scale: 21510  
date: 2017.09.11

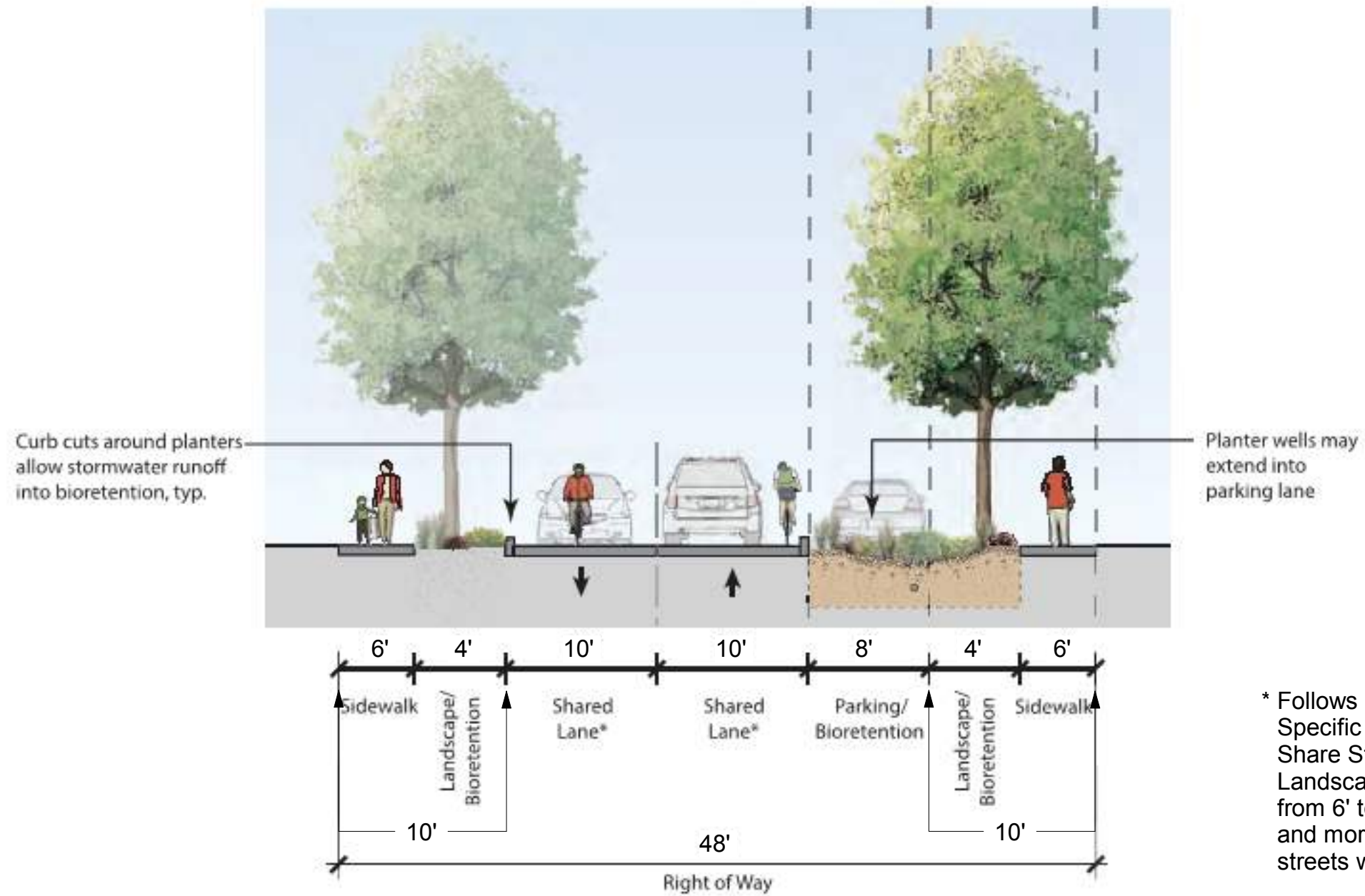

\* Follows Main Street Neighborhood Specific Plan, Fig. 3-15 Neighborhood Share Street, with the exception of Landscape/Bioretentation deviation from 6' to 4' to promote smaller scale and more walkable neighborhood streets within the RESHAP site.

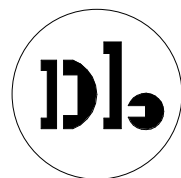

RESHAP

SHARED STREETS

21510  
scale:  
date: 2017.09.11

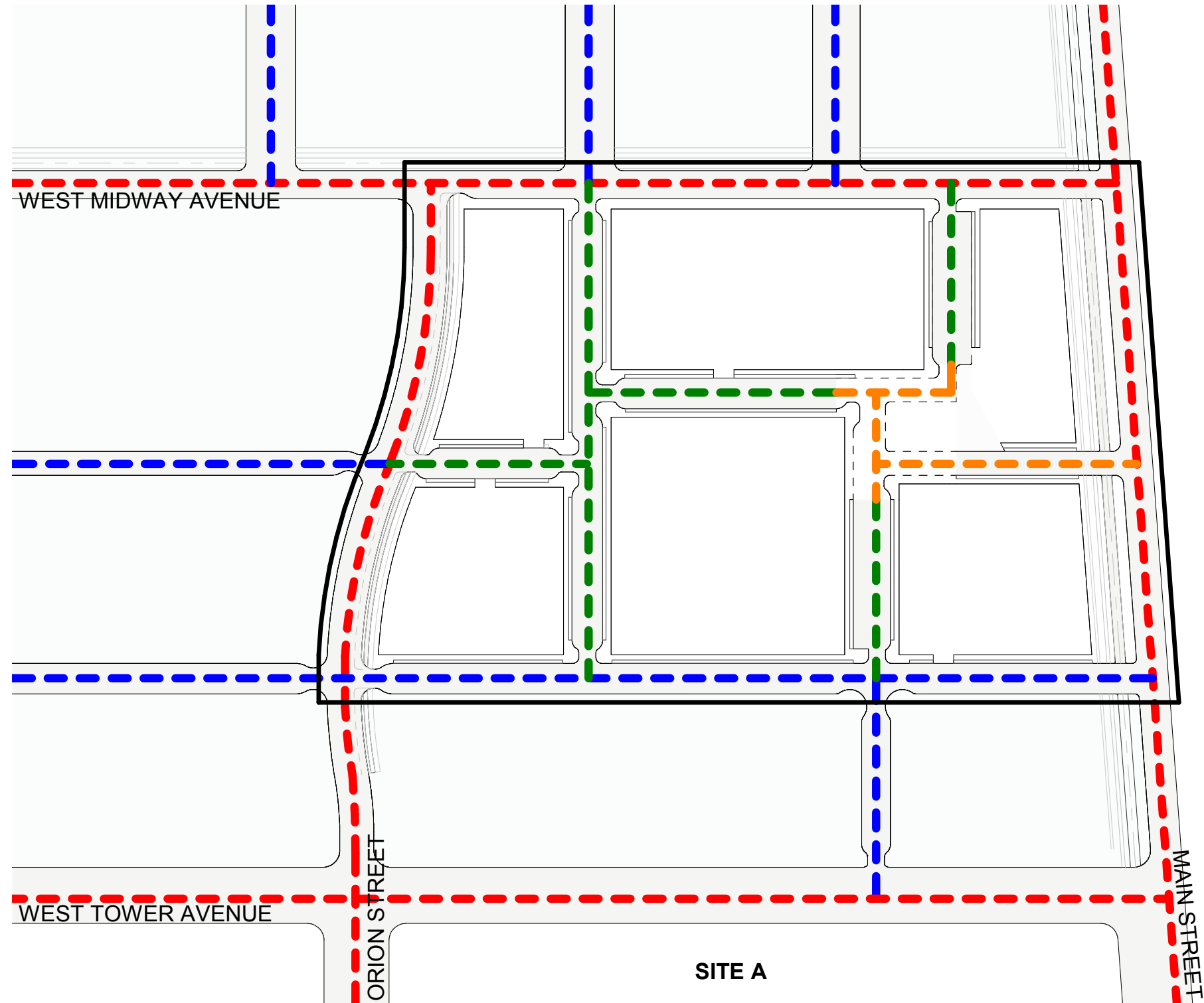

**LEGEND**

- RESHAP SITE
- EXISTING ARTERIAL ROAD TO BE IMPROVED, Per Main Street Specific Plan
- NEW LOCAL STREETS, Per Main Street Specific Plan
- NEW INTERNAL STREETS
- NEW SHARED STREETS

Vehicular Access Plan  
1" = 150'-0"

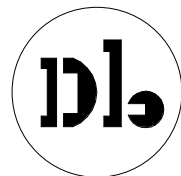

**RESHAP**

**PROPOSED VEHICULAR ACCESS**

21510  
scale: As indicated  
date: 2017.09.11



MAIN STREET NEIGHBORHOOD MULTI-MODAL NETWORK

LEGEND

- |  |                   |  |   |  |                          |
|--|-------------------|--|---|--|--------------------------|
|  | Regional Arterial |  | Separated or Shared Pedestrian/Bike Trail |  | Primary Transit Street   |
|  | Island Arterial   |  | Bike Lane with Barrier (Cycle Track)      |  | Secondary Transit Street |
|  | Island Collector  |  | Bike Lane with Buffer                     |  |                          |
|  | Local Street      |  | Bike Lane with Stripe                     |  |                          |
|  | Project Area      |  | Sharrow/Shared Roadway                    |  |                          |

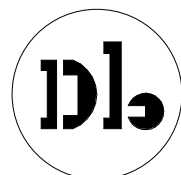

RESHAP

BICYCLE & TRANSIT FACILITIES

21510  
scale:  
date: 2017.09.11

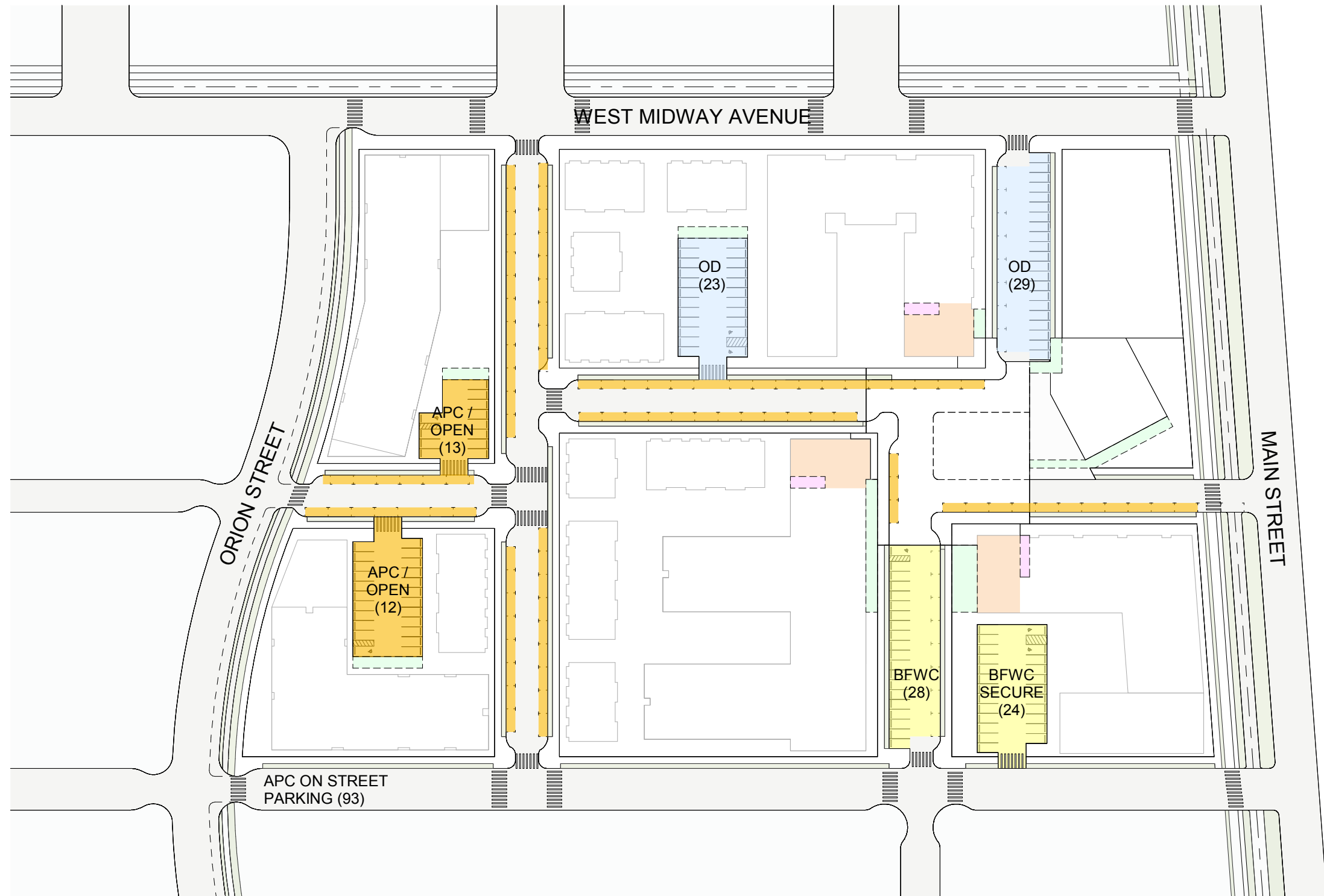

**LEGEND**

- ALAMEDA POINT COLLABORATIVE PARKING (APC)
- BUILDING FUTURES PARKING (BFWC)
- OPERATION DIGNITY PARKING (OD)
- PUBLIC BICYCLE PARKING
- INTERIOR SECURE BICYCLE PARKING
- RESIDENT SERVICES

Parking/Bike Parking Plan  
1" = 100'-0"

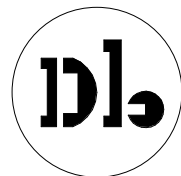

**RESHAP**

**PARKING & BICYCLE PARKING PLAN**

21510  
scale: As indicated  
date: 2017.09.11

SHRUB



Abelia x grandifolia  
Abelia



Acanthus mollis  
Bear's Breech



Aucuba japonica  
Aucuba



Buddleja davidii  
Butterfly Bush



Cistus  
Rockrose



Diestes grandifolia 'Variegata'  
Striped Forsyth Lily



Dodonaea 'Purpurea'  
Purple Hopseed Bush



Hebe  
Hebe



Citrus x meyeri  
Dwarf Citrus Improved Meyer Lemon



Mimulus aurantiacus  
Sticky Monkey Flower



Phormium 'Dazzler'  
Dazzler Flax



Vaccinium darrowii  
Southern High Bush Blueberry



Rosmarinus officinalis  
Tuscan Blue Rosemary



Scaevola aemula  
N.C.N.



Teucrium fruticans  
Compact Bush Germander



Viburnum tinus Dwarf  
Dwarf Viburnum

GROUND COVER



Festuca glauca  
Blue Fescue



Geranium 'Johnson's Blue'  
Johnson's Blue Geranium



Limonium perezii  
Sea Lavender



Fragaria californica  
California Strawberry



Phormium 'Jack Spratt'  
Jack Spratt New Zealand Flax



Thymus citriodorus  
Lemon Thyme



Salvia officinalis  
Garden Sage

VINES



Vitis labrusca 'Concord'  
Concord Grape



Vitis californica  
California Wild Grape

EDIBLE TREES



Prunus avium  
Sweet Cherry



Prunus domestica  
Greengage Plum

BIOSWALE



Carex divisa  
Berkeley Sedge



Chondropetalum tectorum  
Little Cape Rush



Juncus piteus  
California Grey Rush



Lomandria longifolia'  
Mat Rush

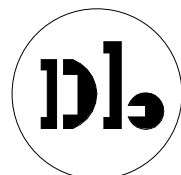

RESHAP

BAY FRIENDLY PLANTING

21510

scale:

date: 2017.09.11



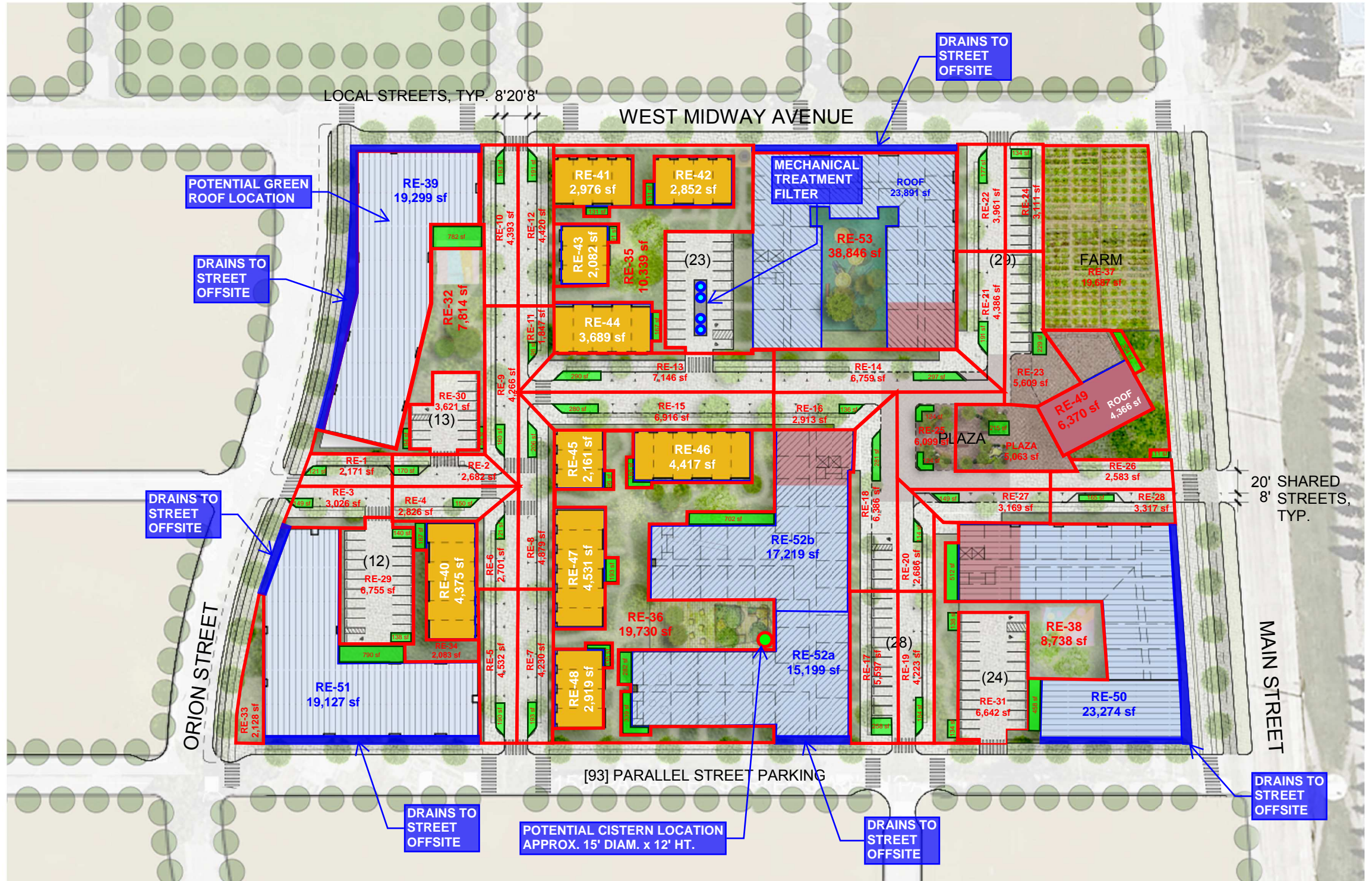

**LEGEND**

- 3 STORY APARTMENTS - ALAMEDA POINT COLLABORATIVE [68 DWELLINGS]
- 3 STORY APARTMENTS - OPERATION DIGNITY [72 DWELLINGS]
- 3 STORY APARTMENTS - BUILDING FUTURES [52 DWELLINGS]
- MIXED-USE / COMMERCIAL BUILDINGS [32 DWELLINGS]
- 2 STORY TOWNHOMES - ALAMEDA POINT COLLABORATIVE [43 DWELLINGS]
- SUPPORTIVE SERVICES SPACES
- 2 STORY BARN / COMMUNITY CENTER
- PLAY AREA
- SHED AREA
- BIORETENTION AREA

RESHAP Illustrative Site Plan  
1" = 100'-0"

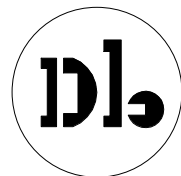

**RESHAP**

**PRELIMINARY STORMWATER MANAGEMENT PLAN**

21510  
scale: As indicated  
date: 2017.08.15

TABLE 1: SHED/TREATMENT SUMMARY

SHED	SHED AREA (S.F.)	ASSUMED IMPERVIOUS COEFFICIENT	TREATMENT AREA REQUIRED (S.F.)	TREATMENT AREA PROVIDED (S.F.)	SURFACE TYPE	TREATMENT MEASURE
RE-1	2,171	1.0	87	121	PAVING/LANDSCAPE	BIORETENTION AREA
RE-2	2,682	1.0	107	170	PAVING/LANDSCAPE	BIORETENTION AREA
RE-3	3,026	1.0	121	149	PAVING/LANDSCAPE	BIORETENTION AREA
RE-4	2,826	1.0	113	150	PAVING/LANDSCAPE	BIORETENTION AREA
RE-5	4,532	1.0	181	190	PAVING/LANDSCAPE	BIORETENTION AREA
RE-6	2,701	1.0	108	121	PAVING/LANDSCAPE	BIORETENTION AREA
RE-7	4,230	1.0	169	193	PAVING/LANDSCAPE	BIORETENTION AREA
RE-8	4,879	1.0	195	206	PAVING/LANDSCAPE	BIORETENTION AREA
RE-9	4,266	1.0	171	180	PAVING/LANDSCAPE	BIORETENTION AREA
RE-10	4,393	1.0	176	183	PAVING/LANDSCAPE	BIORETENTION AREA
RE-11	1,847	1.0	74	98	PAVING/LANDSCAPE	BIORETENTION AREA
RE-12	4,420	1.0	177	191	PAVING/LANDSCAPE	BIORETENTION AREA
RE-13	7,146	1.0	286	290	PAVING/LANDSCAPE	BIORETENTION AREA
RE-14	6,759	1.0	270	297	PAVING/LANDSCAPE	BIORETENTION AREA
RE-15	6,916	1.0	277	280	PAVING/LANDSCAPE	BIORETENTION AREA
RE-16	2,913	1.0	117	136	PAVING/LANDSCAPE	BIORETENTION AREA
RE-17	5,597	1.0	224	258	PAVING/LANDSCAPE	BIORETENTION AREA
RE-18	6,386	1.0	255	281	PAVING/LANDSCAPE	BIORETENTION AREA
RE-19	4,223	1.0	169	184	PAVING/LANDSCAPE	BIORETENTION AREA
RE-20	2,686	1.0	107	114	PAVING/LANDSCAPE	BIORETENTION AREA
RE-21	4,386	1.0	175	191	PAVING/LANDSCAPE	BIORETENTION AREA
RE-22	3,961	1.0	158	177	PAVING/LANDSCAPE	BIORETENTION AREA
RE-23	5,609	1.0	224	229	PAVING/LANDSCAPE	BIORETENTION AREA
RE-24	3,111	1.0	124	134	PAVING/LANDSCAPE	BIORETENTION AREA
RE-25	6,099	1.0	244	248	PAVING/LANDSCAPE	BIORETENTION AREA
RE-26	2,583	1.0	103	136	PAVING/LANDSCAPE	BIORETENTION AREA
RE-27	3,169	1.0	127	149	PAVING/LANDSCAPE	BIORETENTION AREA
RE-28	3,317	1.0	133	165	PAVING/LANDSCAPE	BIORETENTION AREA
RE-29	6,755	1.0	270	278	PAVING/LANDSCAPE	BIORETENTION AREA
RE-30	3,621	1.0	145	182	PAVING/LANDSCAPE	BIORETENTION AREA
RE-31	6,642	1.0	266	272	PAVING/LANDSCAPE	BIORETENTION AREA
RE-32	7,814	N/A	-	-	LANDSCAPE	SELF-TREATING
RE-33	2,128	N/A	-	-	LANDSCAPE	SELF-TREATING
RE-34	2,083	N/A	-	-	LANDSCAPE	SELF-TREATING
RE-35	10,339	N/A	-	-	LANDSCAPE	SELF-TREATING
RE-36	19,730	N/A	-	-	LANDSCAPE	SELF-TREATING
RE-37	19,687	N/A	-	-	LANDSCAPE	SELF-TREATING
RE-38	8,738	N/A	-	-	LANDSCAPE	SELF-TREATING
RE-39	19,299	1.0	772	782	ROOF	BIORETENTION AREA
RE-39	19,299	N/A	-	-	ROOF	POTENTIAL GREEN ROOF
RE-40	4,375	1.0	175	187	ROOF	BIORETENTION AREA
RE-41	2,976	1.0	119	131	ROOF	BIORETENTION AREA
RE-42	2,852	1.0	114	131	ROOF	BIORETENTION AREA
RE-43	2,082	1.0	83	91	ROOF	BIORETENTION AREA
RE-44	3,689	1.0	148	167	ROOF	BIORETENTION AREA
RE-45	2,161	1.0	86	96	ROOF	BIORETENTION AREA
RE-46	4,417	1.0	177	180	ROOF	BIORETENTION AREA
RE-47	4,531	1.0	181	193	ROOF	BIORETENTION AREA
RE-48	2,919	1.0	117	135	ROOF	BIORETENTION AREA
RE-49	6,370	1.0	255	290	ROOF/PAVING	BIORETENTION AREA
RE-50	23,274	1.0	931	970	ROOF	BIORETENTION AREA
RE-51	19,127	1.0	765	790	ROOF	BIORETENTION AREA
RE-52a	15,199	N/A	-	-	ROOF	POTENTIAL RAINWATER HARVESTING
RE-52b	15,199	1.0	608	621	ROOF	BIORETENTION AREA
RE-52b	17,219	1.0	689	702	ROOF	BIORETENTION AREA
RE-53	38,846	N/A	-	-	ROOF/PAVING/LANDSCAPE	MECHANICAL FILTER

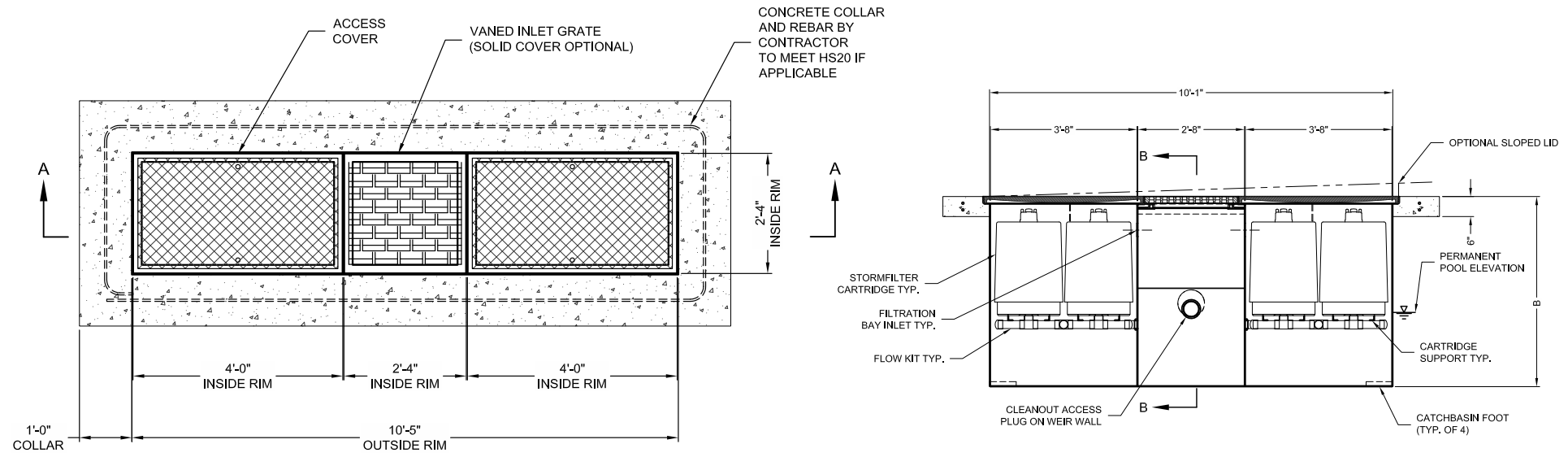

PLAN VIEW  
27" CARTRIDGES

1 MECHANICAL STORMWATER FILTER  
NTS

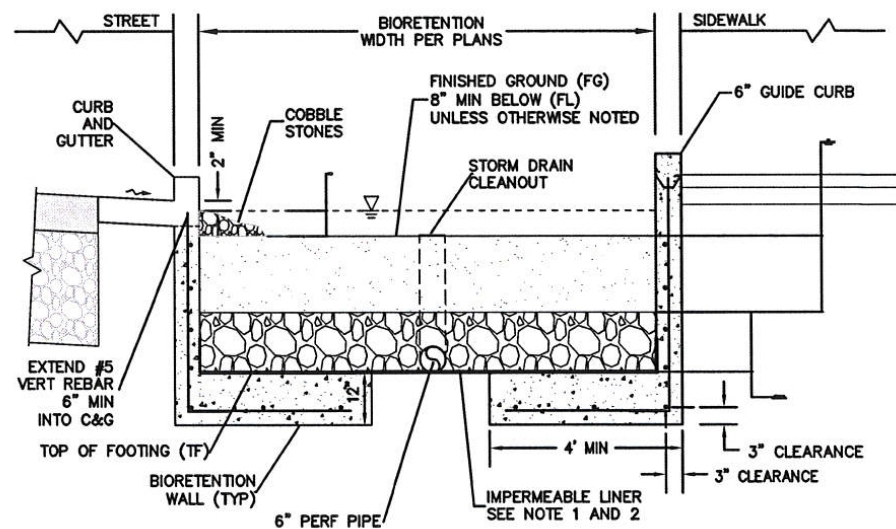

2 BIORETENTION AREA (STRUCTURED)  
NTS

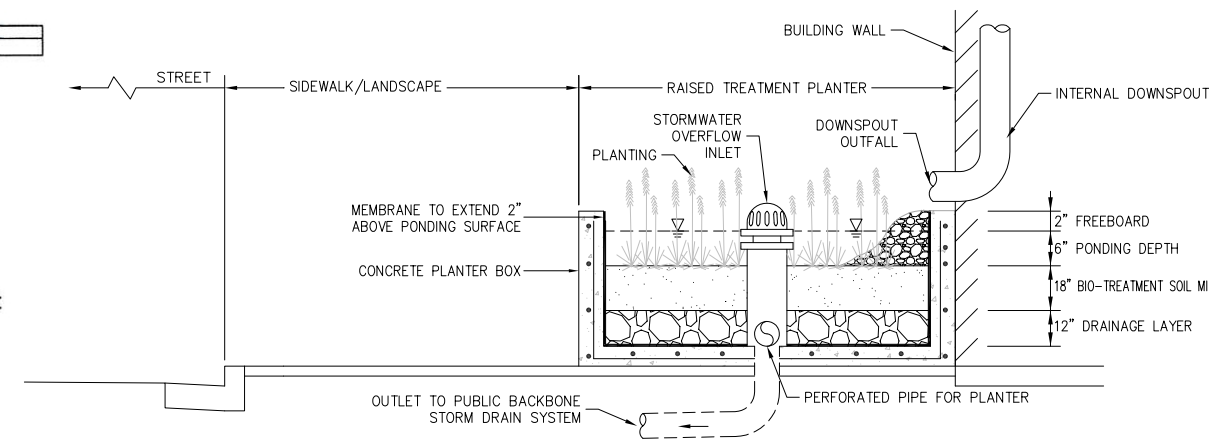

3 FLOW-THROUGH PLANTER  
NTS

EXHIBIT C

LIST OF IMPACT FEES

Exhibit C: List of Impact fees

The fees listed below are the impact fees in place in the City of Alameda as of the date of the Development Agreement.

<u>Impact Fee Name</u>	<u>Alameda Municipal Code</u>
Improvement Tax	AMC Section 3-62
Affordable Housing Fee	AMC Section 27-1
Alameda Point Development Impact Fee	AMC Section 27-3
Sewer Connection Fee	AMC Section 18.3
Public Art Fee	AMC Section 30.98

EXHIBIT D

INITIAL PHASING PLAN



ILLUSTRATIVE SITE PLAN - PHASE 1



ILLUSTRATIVE SITE PLAN - PHASE 2

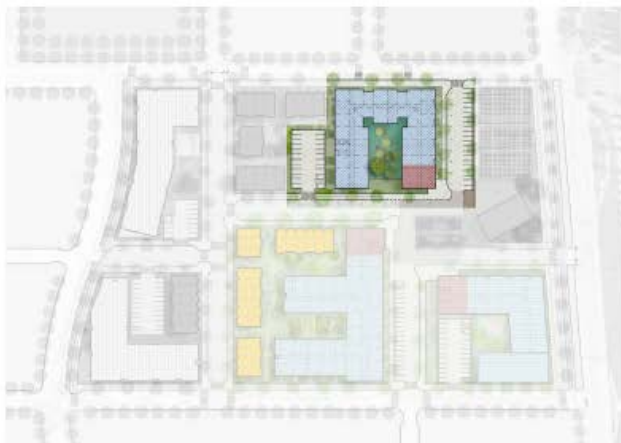

ILLUSTRATIVE SITE PLAN - PHASE 3



ILLUSTRATIVE SITE PLAN - PHASE 4