

File: P:\Utility Projects\Alameda - 773\773.02.05 - Grand Street - 0806.2 - Rehabilitation\CAD\Sheet\06 - Striping Grand Street.dwg | Layout: C6 | Printed: Nov 02, 2021 @ 8:29am | 11.05.22.06 (LUS Tech)

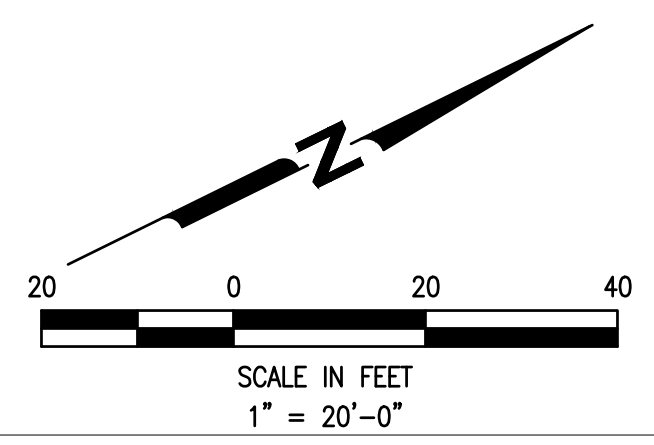
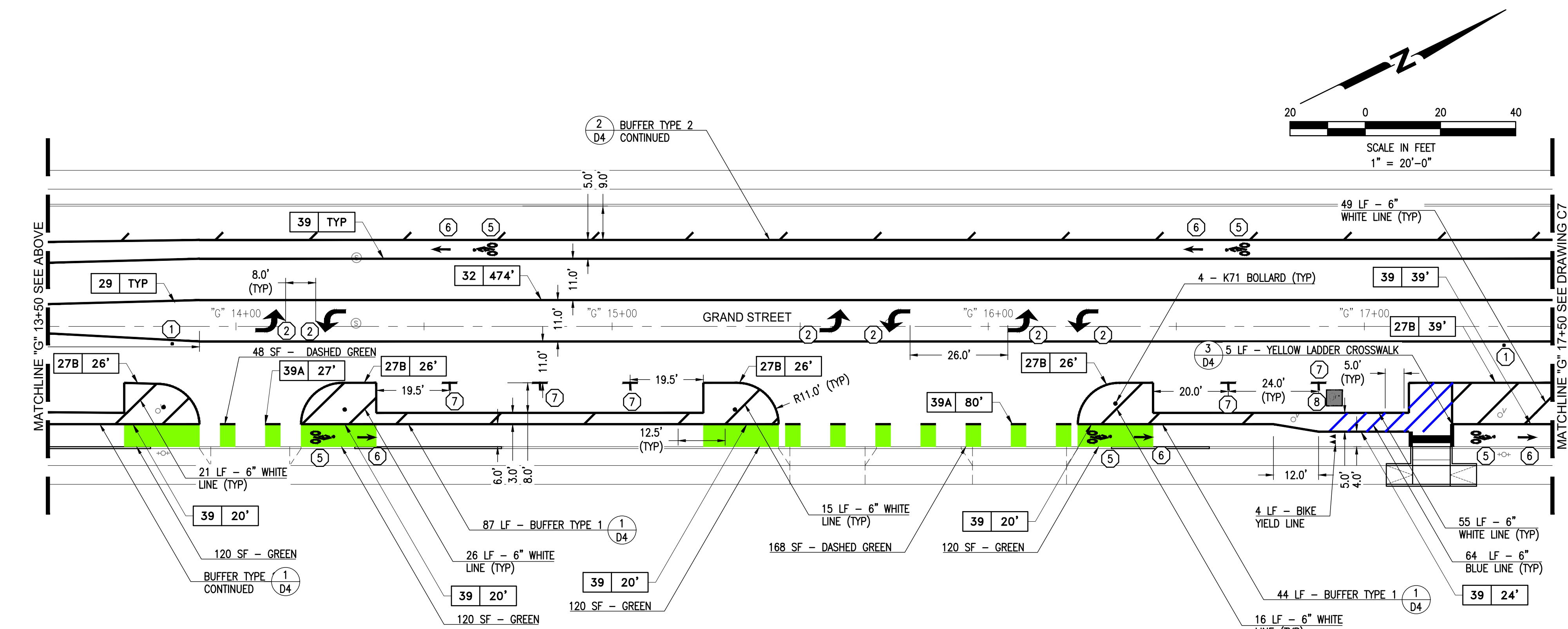
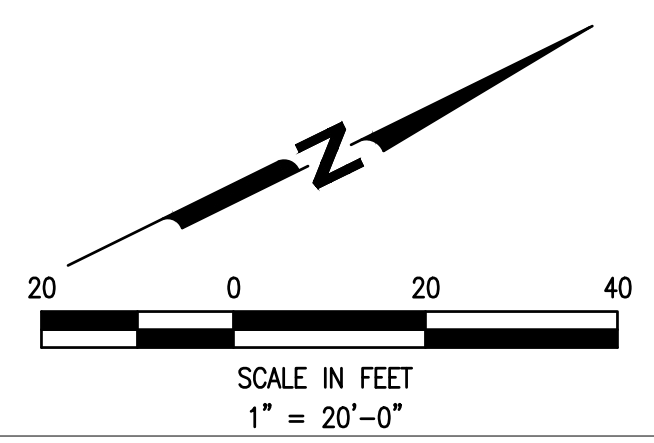
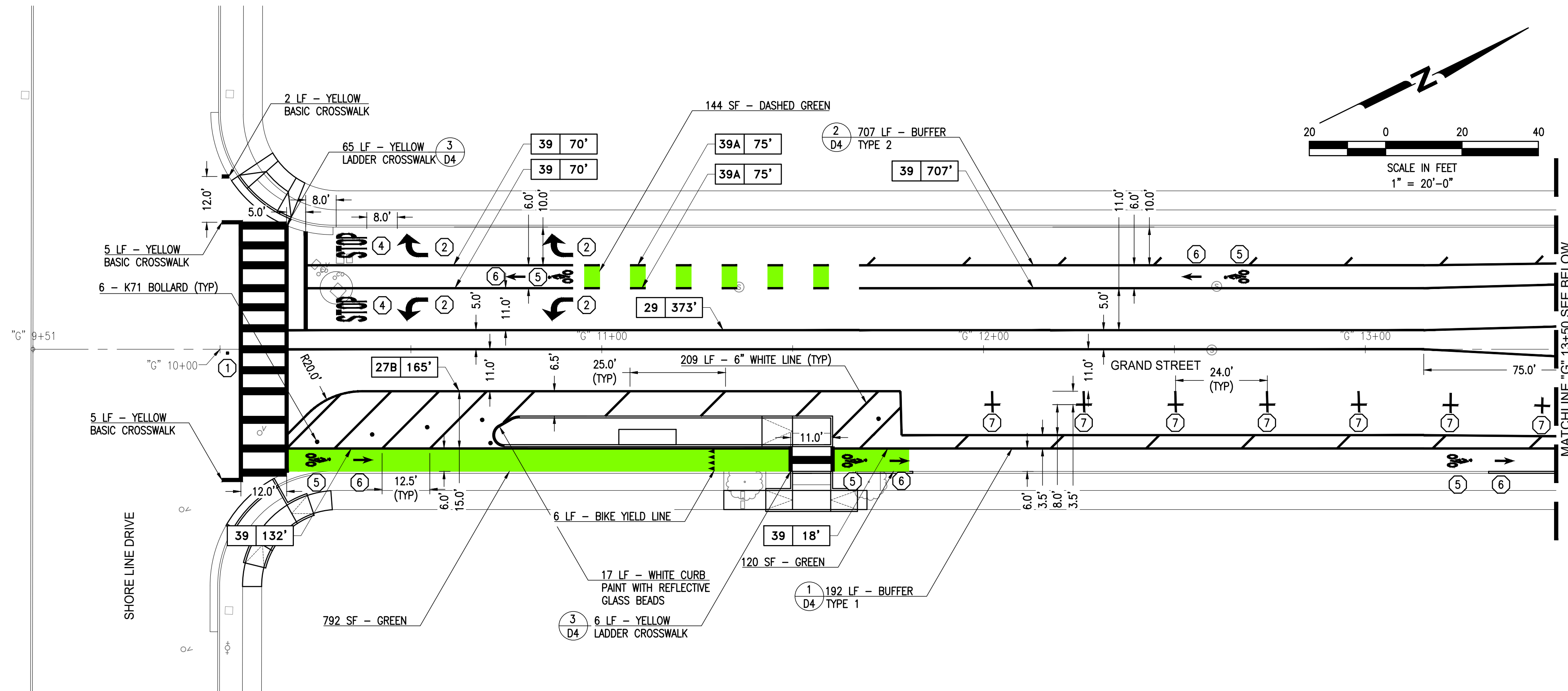

NOTES:

1. FOR GENERAL NOTES, LEGEND AND ABBREVIATIONS, SEE SHEET 2.
2. CONTRACTOR SHALL REMOVE "BIKE ROUTE" (D11-1) SIGNAGE ALONG GRAND STREET.

KEYNOTES:

- ① INSTALL FIRE HYDRANT BLUE MARKER
- ② INSTALL CALTRANS "TYPE IV" ARROW
- ③ INSTALL CALTRANS "TYPE VII" ARROW
- ④ INSTALL CALTRANS PAVEMENT MARKING "STOP"
- ⑤ INSTALL CALTRANS BIKE LANE SYMBOL WITH PERSON
- ⑥ INSTALL CALTRANS BIKE LANE ARROW
- ⑦ INSTALL PARKING "T"; SEE DETAIL 4/D4
- ⑧ INSTALL CALTRANS ISA MARKING



501 Canal Blvd., Suite I
 Richmond, Ca. 94804
 (510) 215-3620 * Fax (510) 215-2898



GRAND STREET OBAG 2 REHABILITATION

OWNER



950 W MALL SQUARE
 ALAMEDA, CA. 94501

NO.	DATE	DESCRIPTION
PROJECT NO:	773.10.55	
DESIGNED BY:	SD	
DRAWN BY:	AP, SD	
CHECKED BY:	FH	DATE: 11/02/2021
DATE:	11/05/2021	

This drawing is the property of NCE, including all patented and patentable features, and/or confidential information and its use is conditioned upon the user's agreement not to reproduce the drawing, in whole or part, nor the material described thereon, nor the use of the drawing for any purpose other than specifically permitted in writing by NCE.

SHEET TITLE

STRIPING GRAND STREET "G" 9+51 TO "G" 17+50

DRAWING

C6

65% SUBMITTAL
PRELIMINARY
FOR REVIEW
NOT FOR CONSTRUCTION
 DATE: 11/05/2021



File: P:\Mobile Projects\Alameda - 7731721.055 - Grand Street - 0805 2 Rehabilitation\CAD\Sheet\09_06 - Striping Grand Street.dwg | Layout: C7 | Printed: Nov 02, 2021 @ 8:29am | 0.50:22.0x (US: Feet)

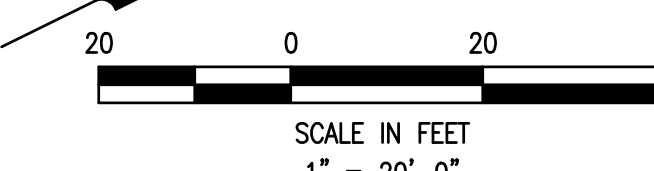
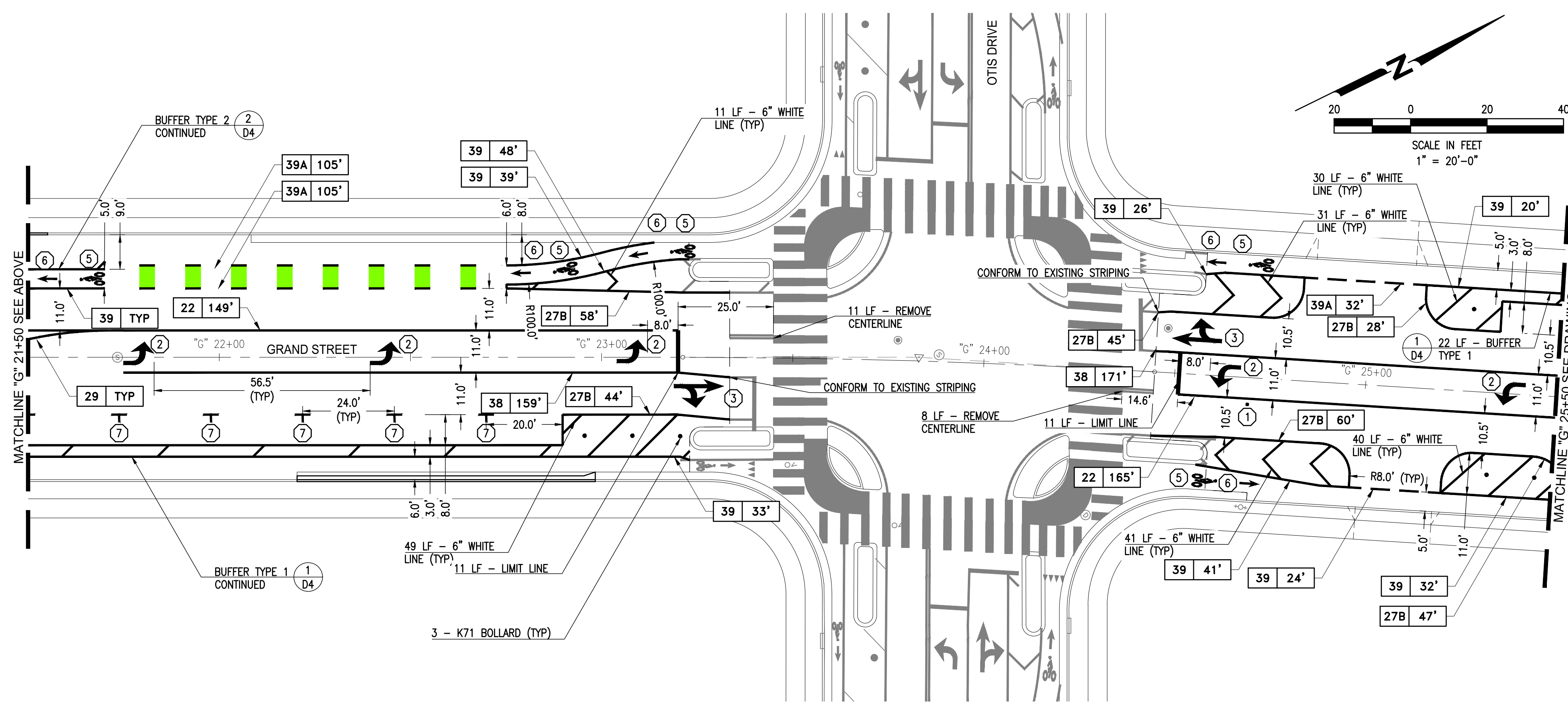
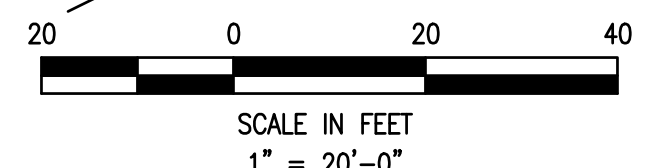
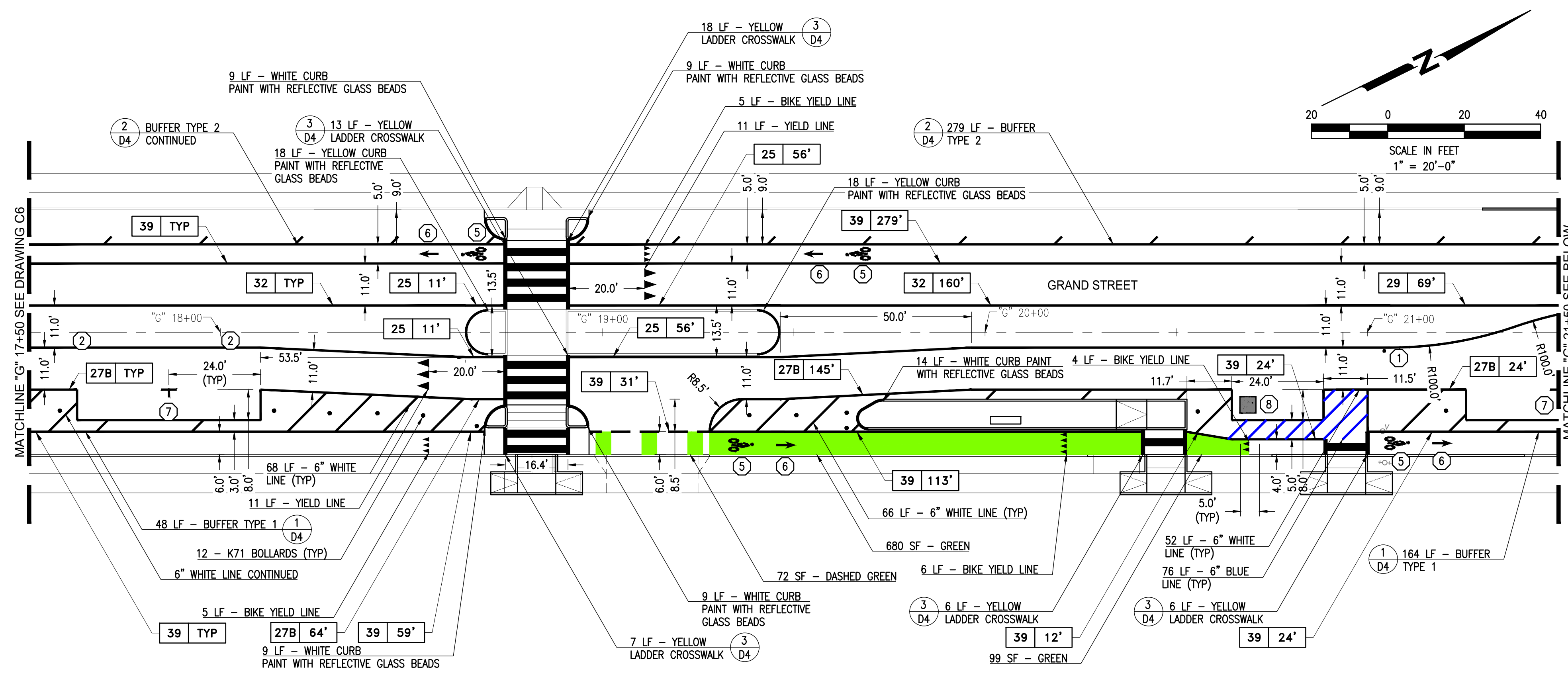

NOTES:

- FOR GENERAL NOTES, LEGEND AND ABBREVIATIONS, SEE SHEET 2.
- CONTRACTOR SHALL REMOVE "BIKE ROUTE" (D11-1) SIGNAGE ALONG GRAND STREET.

KEYNOTES:

- INSTALL FIRE HYDRANT BLUE MARKER
- INSTALL CALTRANS "TYPE IV" ARROW
- INSTALL CALTRANS "TYPE VII" ARROW
- INSTALL CALTRANS PAVEMENT MARKING "STOP"
- INSTALL CALTRANS BIKE LANE SYMBOL WITH PERSON
- INSTALL CALTRANS BIKE LANE ARROW
- INSTALL PARKING "T"; SEE DETAIL 4/D4
- INSTALL CALTRANS ISA MARKING



501 Canal Blvd., Suite I
Richmond, Ca. 94804
(510) 215-3620 * Fax (510) 215-2898

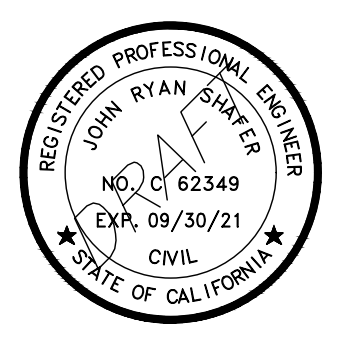
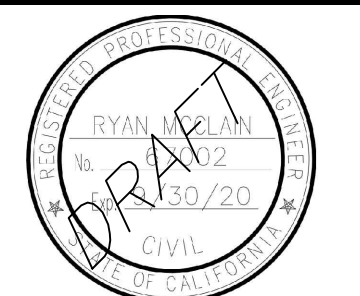

GRAND STREET OBAG 2 REHABILITATION

OWNER



950 W MALL SQUARE
ALAMEDA, CA. 94501

NO.	DATE	DESCRIPTION

PROJECT NO:	773.10.55
DESIGNED BY:	SD
DRAWN BY:	AP, SD
CHECKED BY:	FH
DATE:	11/02/2021
DATE:	11/05/2021

This drawing is the property of NCE, including all patented and patentable features, and/or confidential information and its use is conditioned upon the user's agreement not to reproduce the drawing, in whole or part, nor the material described thereon, nor the use of the drawing for any purpose other than specifically permitted in writing by NCE.

SHEET TITLE

STRIPING GRAND STREET "G" 17+50 TO "G" 25+50

DRAWING

C7

SHEET 10 OF 19

65% SUBMITTAL
PRELIMINARY
FOR REVIEW
NOT FOR CONSTRUCTION
DATE: 11/05/2021



File: P:\Metric Projects\Alameda - 773-773-10-05 - Grand Street - 0815-2 Rehabilitation\CAD\Sheet\08_C8 - Striping Grand Street.dwg | Layout: C8 | Printed: Nov 07, 2021 @ 8:29am | 10:50:22:0a (US: Tech)

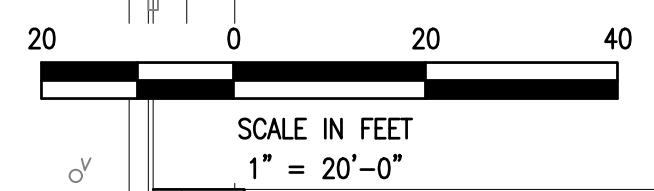
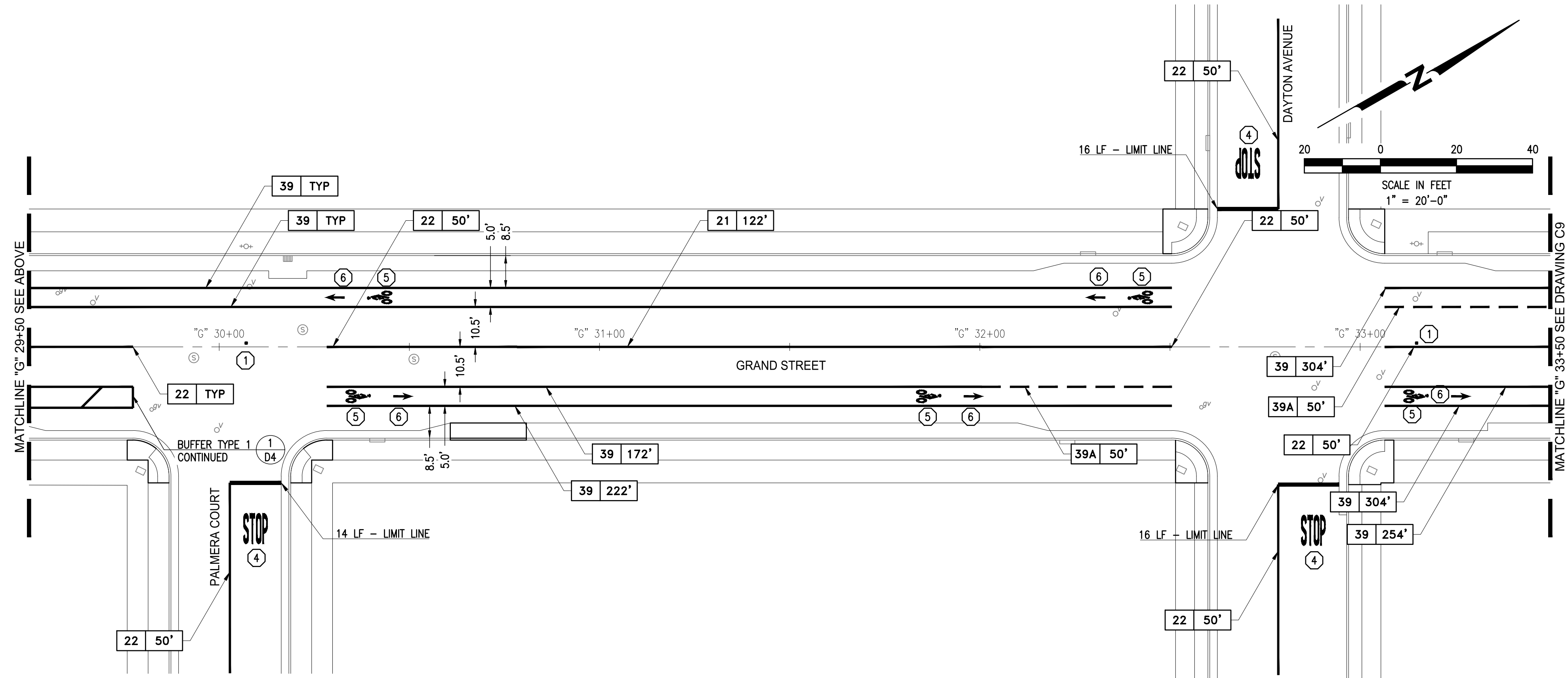
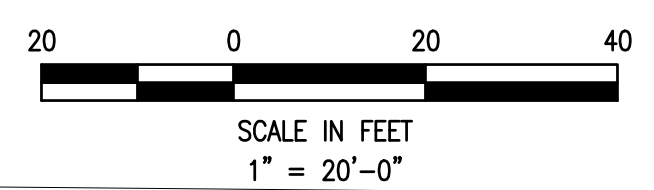
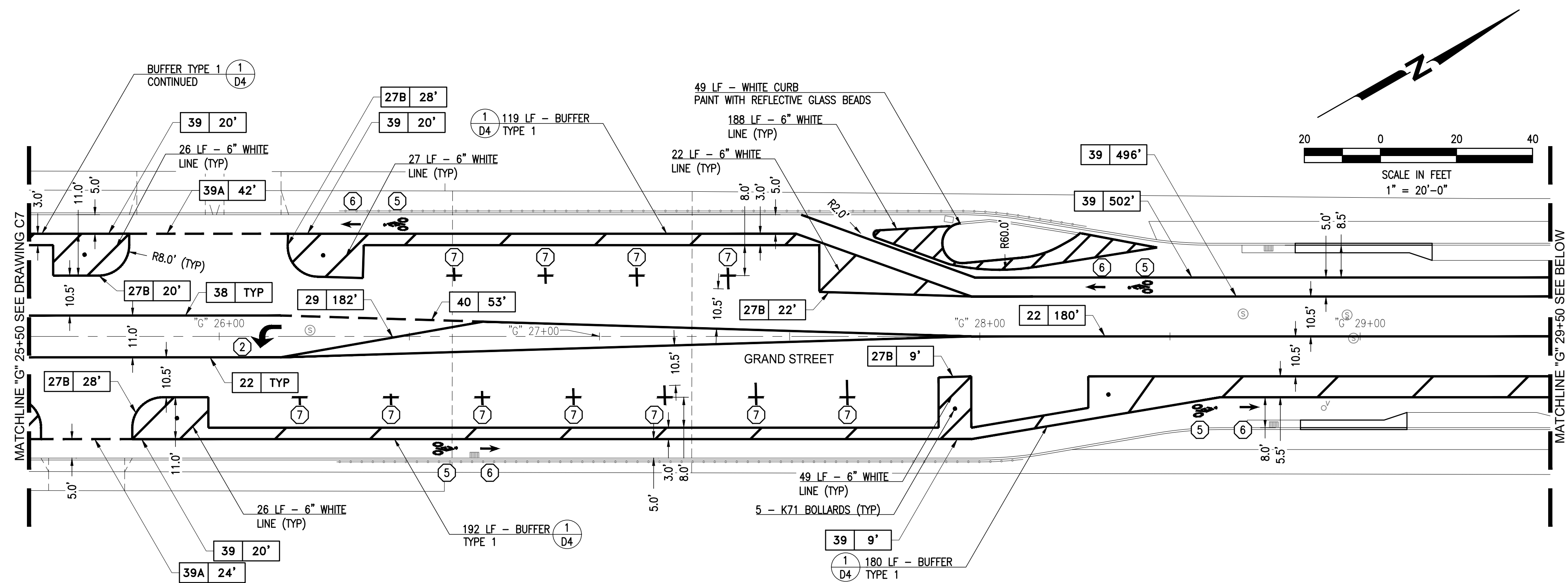

NOTES:

1. FOR GENERAL NOTES, LEGEND AND ABBREVIATIONS, SEE SHEET 2.
2. CONTRACTOR SHALL REMOVE "BIKE ROUTE" (D11-1) SIGNAGE ALONG GRAND STREET.

KEYNOTES:

- ① INSTALL FIRE HYDRANT BLUE MARKER
- ② INSTALL CALTRANS "TYPE IV" ARROW
- ③ INSTALL CALTRANS "TYPE VII" ARROW
- ④ INSTALL CALTRANS PAVEMENT MARKING "STOP"
- ⑤ INSTALL CALTRANS BIKE LANE SYMBOL WITH PERSON
- ⑥ INSTALL CALTRANS BIKE LANE ARROW
- ⑦ INSTALL PARKING "T"; SEE DETAIL 4/D4
- ⑧ INSTALL CALTRANS ISA MARKING



501 Canal Blvd., Suite I
Richmond, Ca. 94804
(510) 215-3620 * Fax (510) 215-2898



GRAND STREET OBAG 2 REHABILITATION

OWNER



950 W MALL SQUARE
ALAMEDA, CA. 94501

NO.	DATE	DESCRIPTION

PROJECT NO:	773.10.55
DESIGNED BY:	SD
DRAWN BY:	AP, SD
CHECKED BY:	FH DATE: 11/02/2021
DATE:	11/05/2021

This drawing is the property of NCE, including all patented and patentable features, and/or confidential information and its use is conditioned upon the user's agreement not to reproduce the drawing, in whole or part, nor the material described thereon, nor the use of the drawing for any purpose other than specifically permitted in writing by NCE.

SHEET TITLE

STRIPING GRAND STREET "G" 25+50 TO "G" 33+50

DRAWING

C8

**65% SUBMITTAL
PRELIMINARY
FOR REVIEW
NOT FOR CONSTRUCTION
DATE: 11/05/2021**



File: P:\Metric Projects\Alameda - 773773.055 - Grand Street - 0815.2 Rehabilitation\CAD\Sheet\09_C9 - Striping Grand Street.dwg | Layout: C9 | Printed: Nov 07, 2021 @ 8:23am | 10.50x22.00 (US, Feet)

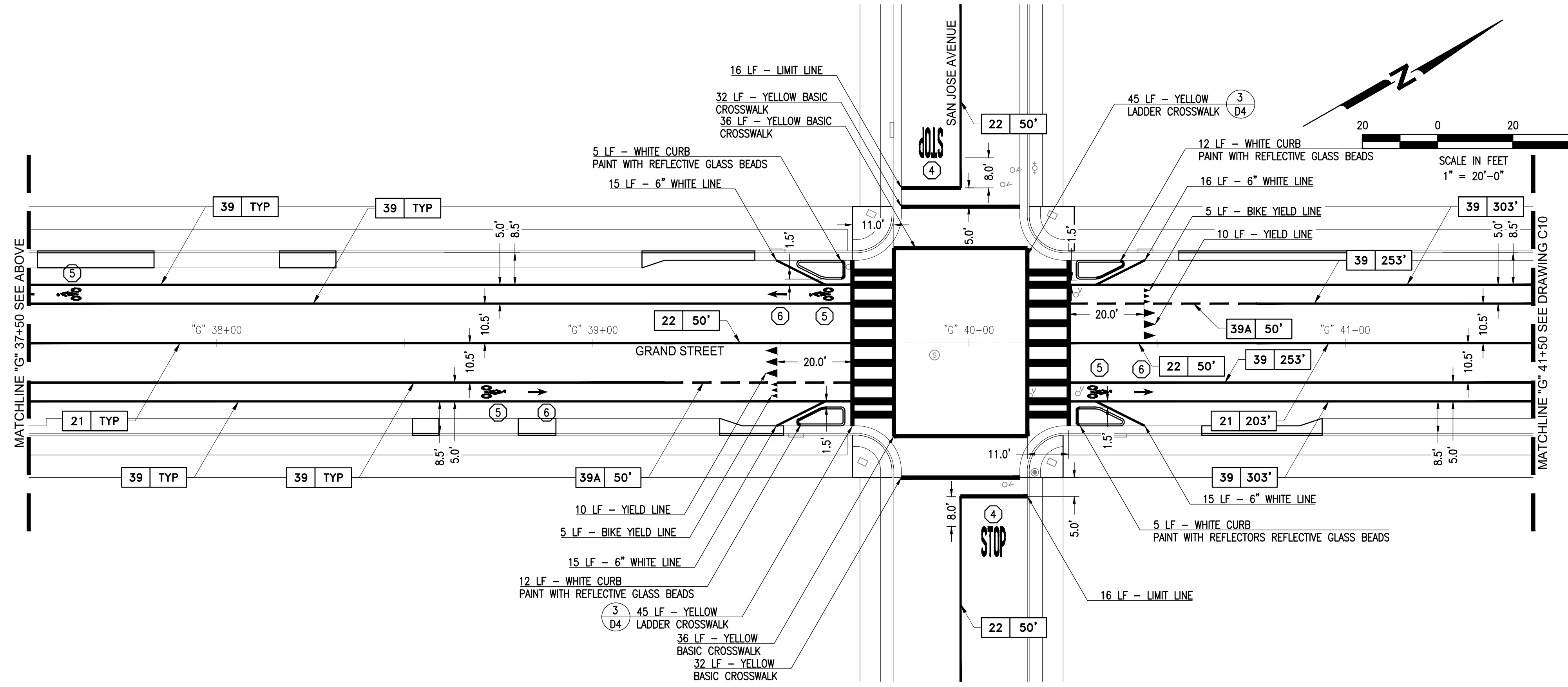
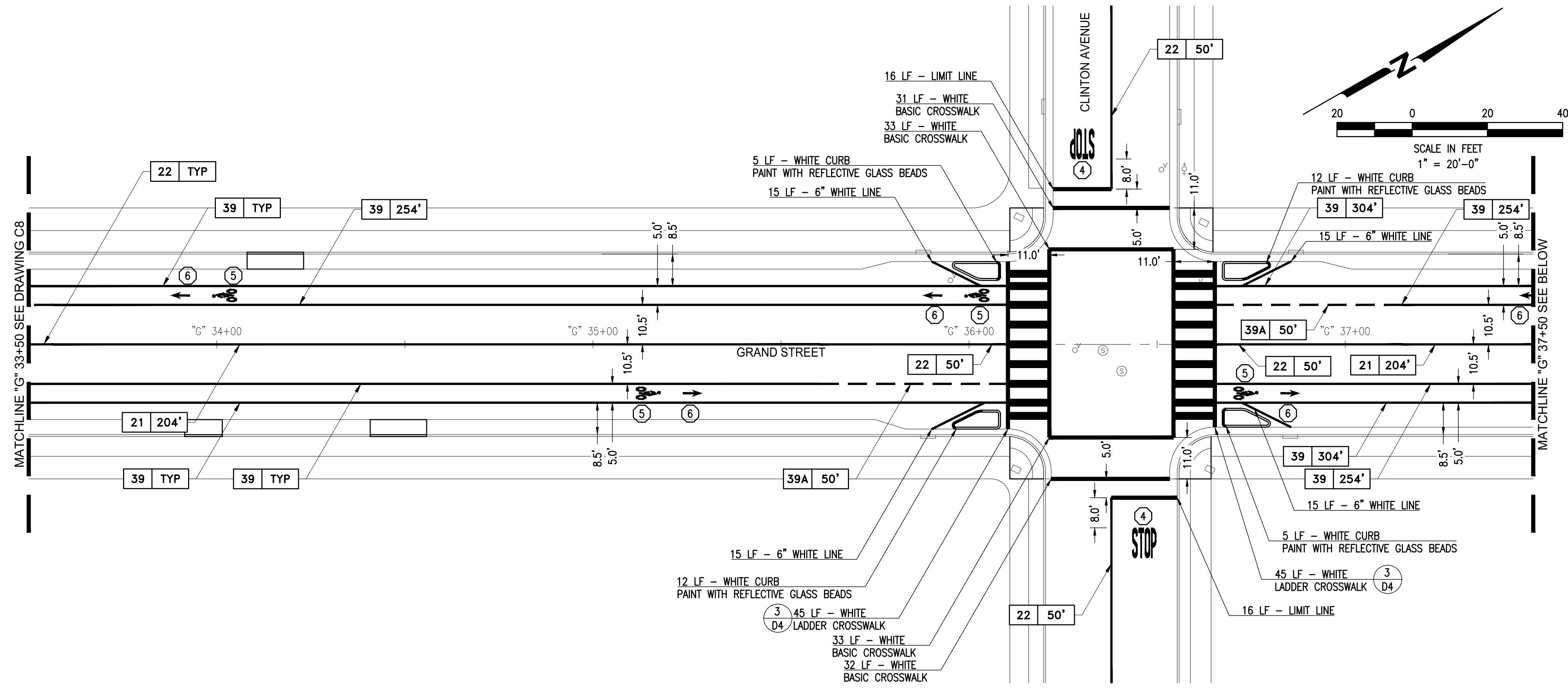

- NOTES:**
- FOR GENERAL NOTES, LEGEND AND ABBREVIATIONS, SEE SHEET 2.
 - CONTRACTOR SHALL REMOVE "BIKE ROUTE" (D11-1) SIGNAGE ALONG GRAND STREET.

- KEYNOTES:**
- INSTALL FIRE HYDRANT BLUE MARKER
 - INSTALL CALTRANS "TYPE IV" ARROW
 - INSTALL CALTRANS "TYPE VII" ARROW
 - INSTALL CALTRANS PAVEMENT MARKING "STOP"
 - INSTALL CALTRANS BIKE LANE SYMBOL WITH PERSON
 - INSTALL CALTRANS BIKE LANE ARROW
 - INSTALL PARKING "T"; SEE DETAIL 4/D4
 - INSTALL CALTRANS ISA MARKING

NCE
 501 Canal Blvd., Suite I
 Richmond, Ca. 94804
 (510) 215-3620 * Fax (510) 215-2898

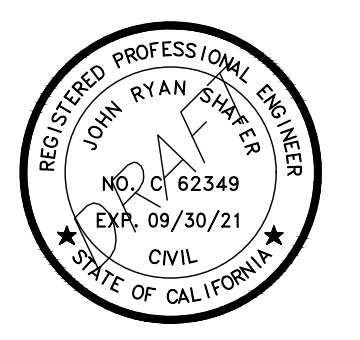
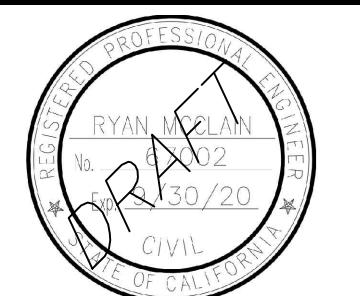

GRAND STREET OBAG 2 REHABILITATION

OWNER



950 W MALL SQUARE
 ALAMEDA, CA. 94501

NO.	DATE	DESCRIPTION

PROJECT NO: 773.10.55
 DESIGNED BY: SD
 DRAWN BY: AP, SD
 CHECKED BY: FH DATE: 11/02/2021
 DATE: 11/05/2021

STRIPING GRAND STREET "G" 33+50 TO "G" 41+50

DRAWING
C9
 SHEET 12 OF 19

**65% SUBMITTAL
 PRELIMINARY
 FOR REVIEW
 NOT FOR CONSTRUCTION
 DATE: 11/05/2021**



File: P:\Metric Projects\Alameda - 773\773.055 - Grand Street - 0815 2 Rehabilitation\CAD\Sheet\13 C10 - Striping Grand Street.dwg | Layout: C10 | Printed Nov 07, 2021 @ 8:23am | 10:50:22.0s (US Feet)

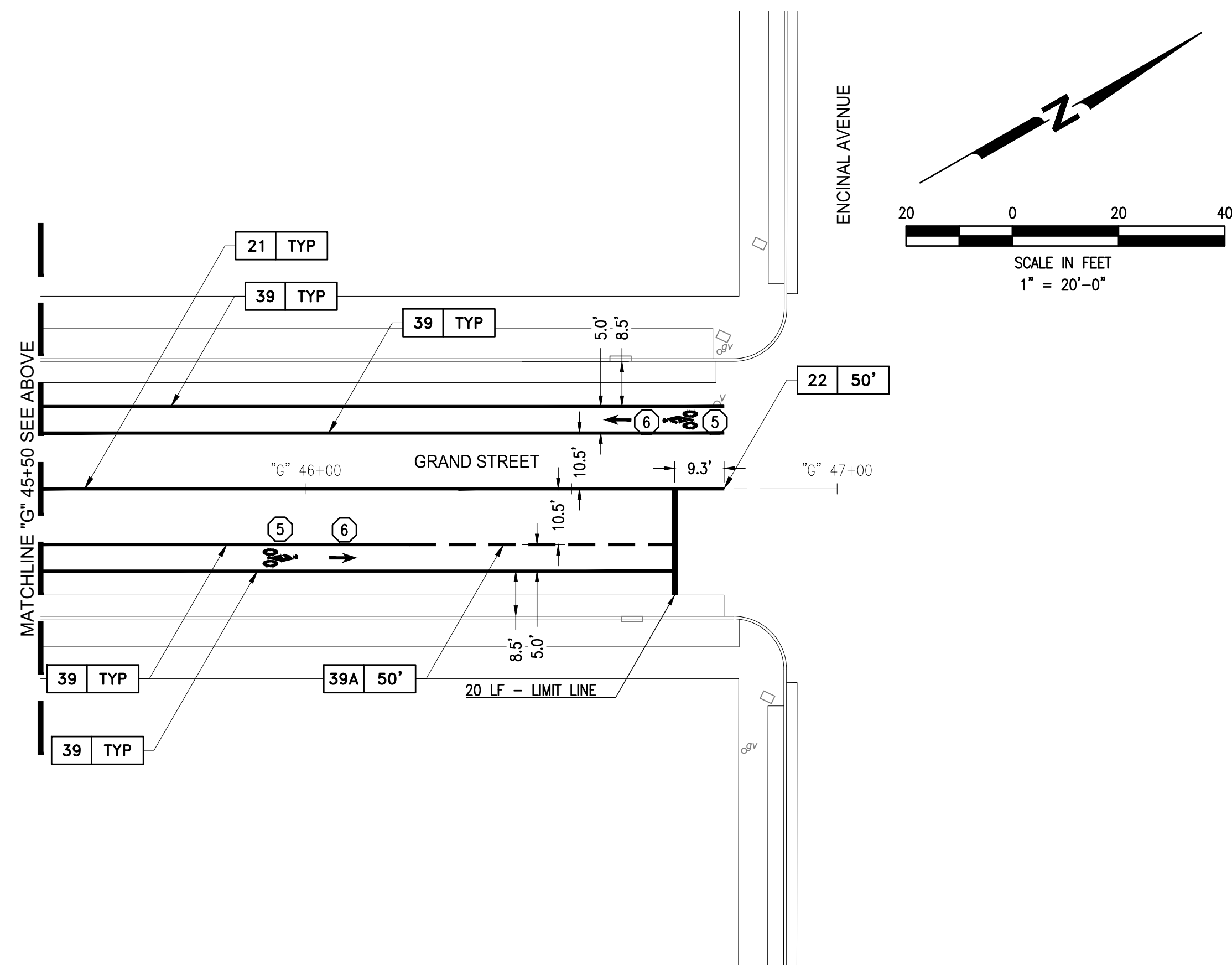
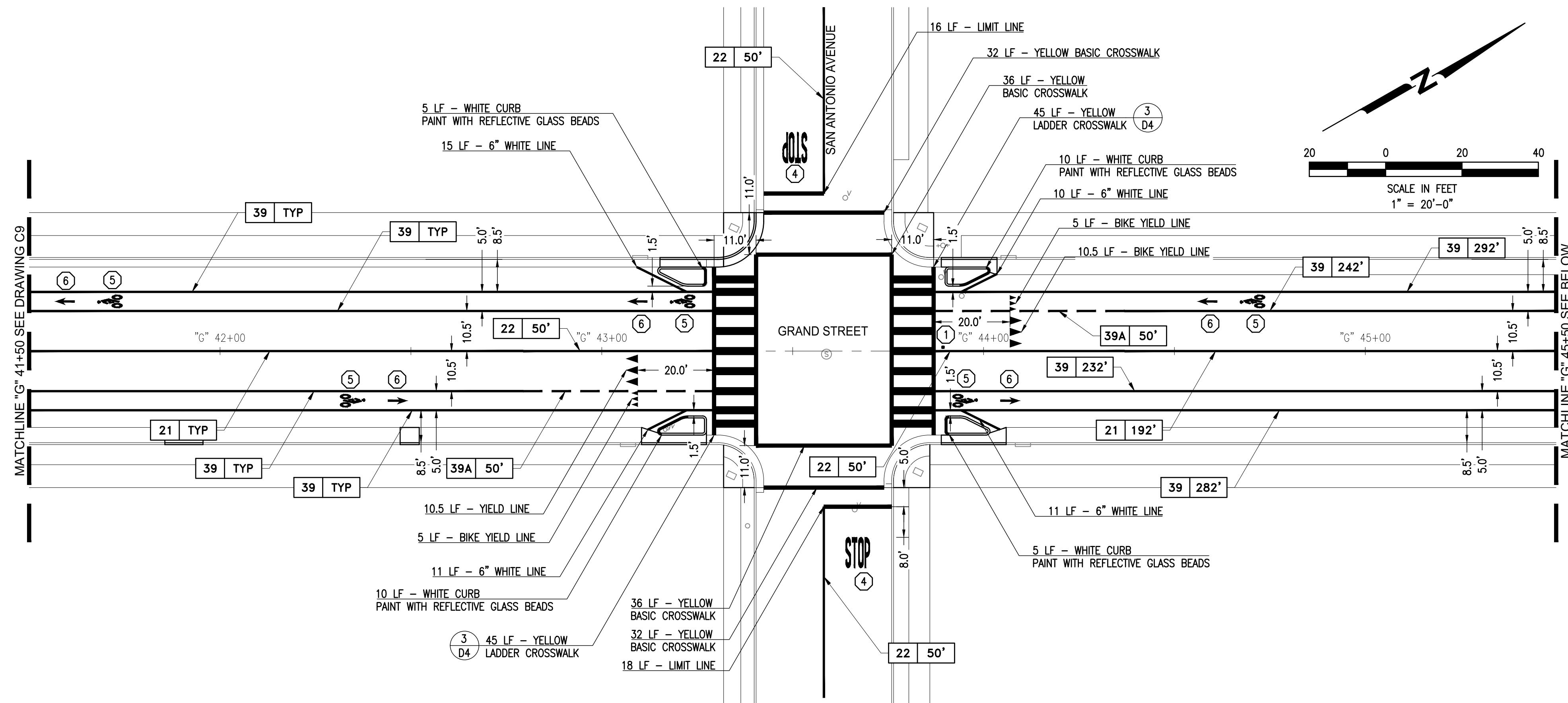

NOTES:

1. FOR GENERAL NOTES, LEGEND AND ABBREVIATIONS, SEE SHEET 2.
2. CONTRACTOR SHALL REMOVE "BIKE ROUTE" (D11-1) SIGNAGE ALONG GRAND STREET.

KEYNOTES:

- ① INSTALL FIRE HYDRANT BLUE MARKER
- ② INSTALL CALTRANS "TYPE IV" ARROW
- ③ INSTALL CALTRANS "TYPE VII" ARROW
- ④ INSTALL CALTRANS PAVEMENT MARKING "STOP"
- ⑤ INSTALL CALTRANS BIKE LANE SYMBOL WITH PERSON
- ⑥ INSTALL CALTRANS BIKE LANE ARROW
- ⑦ INSTALL PARKING "T"; SEE DETAIL 4/D4
- ⑧ INSTALL CALTRANS ISA MARKING



501 Canal Blvd., Suite I
 Richmond, Ca. 94804
 (510) 215-3620 * Fax (510) 215-2898

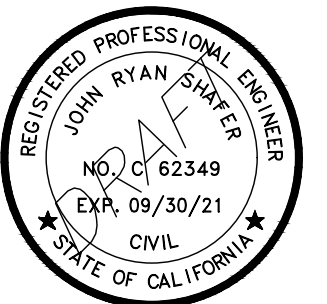

**GRAND STREET OBAG 2
 REHABILITATION**

OWNER



950 W MALL SQUARE
 ALAMEDA, CA. 94501

NO.	DATE	DESCRIPTION

PROJECT NO:	773.10.55
DESIGNED BY:	SD
DRAWN BY:	AP, MPM, SD
CHECKED BY:	FH DATE: 11/02/2021
DATE:	11/05/2021

This drawing is the property of NCE, including all patented and patentable features, and/or confidential information and its use is conditioned upon the user's agreement not to reproduce the drawing, in whole or part, nor the material described thereon, nor the use of the drawing for any purpose other than specifically permitted in writing by NCE.

SHEET TITLE

**STRIPING GRAND
 STREET "G" 41+50 TO "G"
 47+00**

DRAWING

C10

**65% SUBMITTAL
 PRELIMINARY
 FOR REVIEW
 NOT FOR CONSTRUCTION
 DATE: 11/05/2021**

