

# Alameda Parklet Barriers

Bohlmann BC48

- Dimensions:  
48"L x 24"W x 35"H
- Weight: 1225 lbs.
- Reinforced welded steel rebar frames
- Stain color: Patio Green

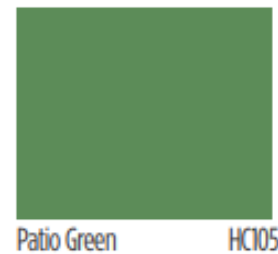

Images: Alameda.png; Xrefs: Path: F:\BMAP-STD\Alameda\Std\2021 Std Update\ST 17-1.dwg Layout Name: ST 17-1 Plot Date: Dec 07, 2021 at 13:52

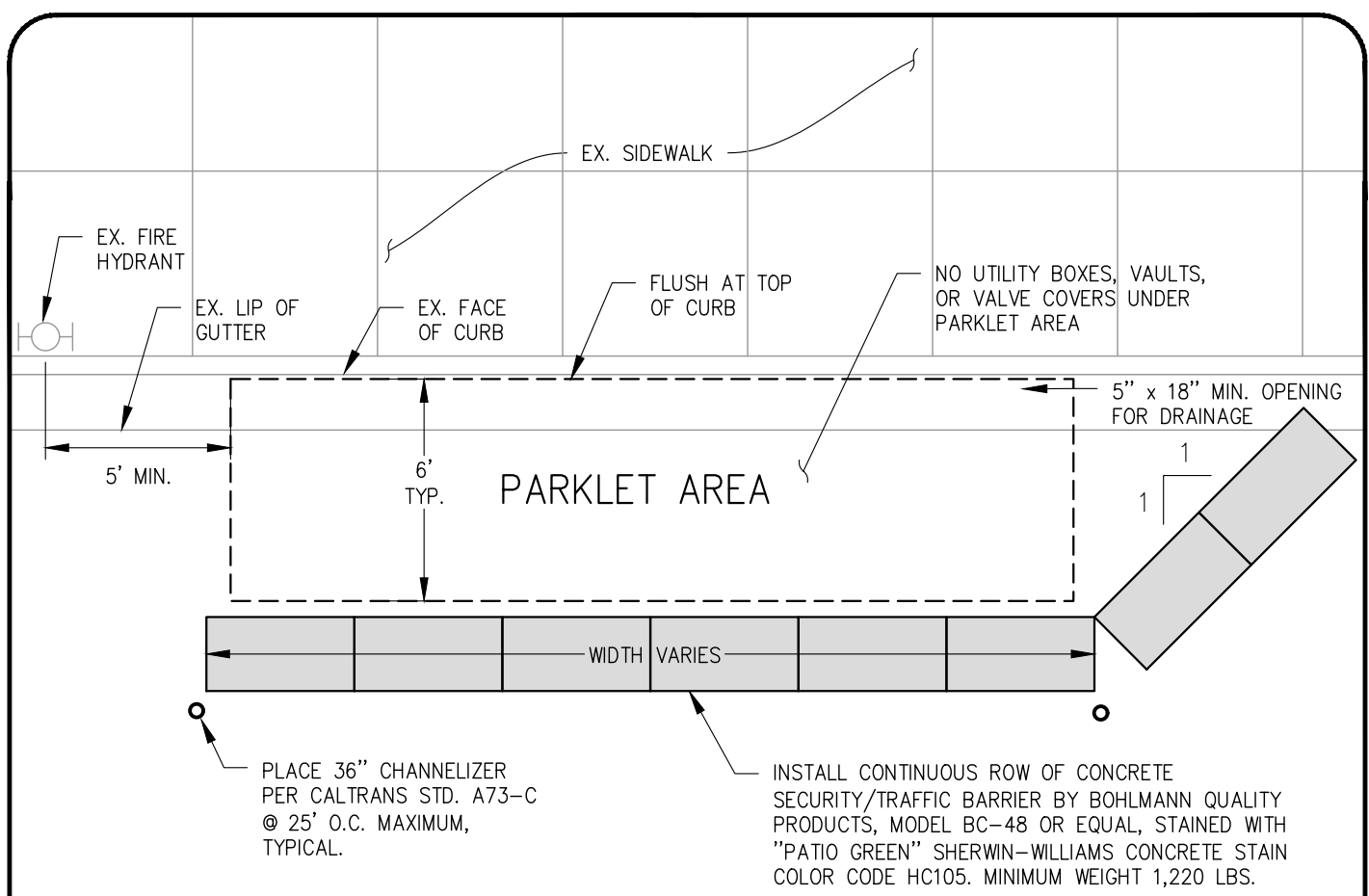

PLAN VIEW

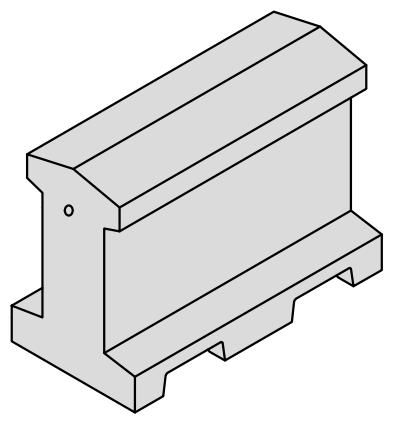
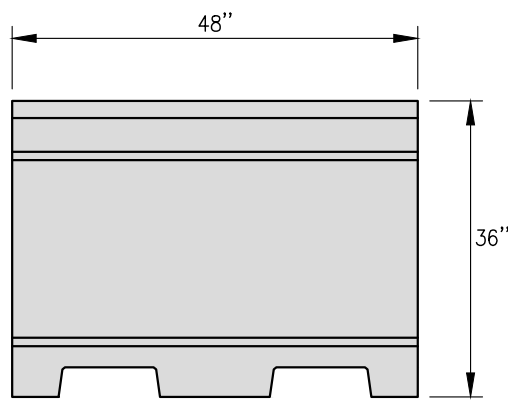
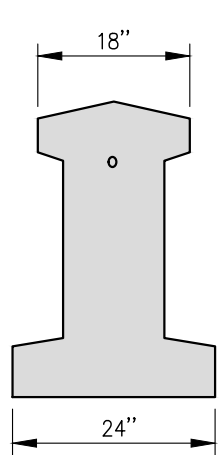

PRECAST CONCRETE BARRICADE  
(BOHLMANN BC-48 OR EQUAL)

\* NOTE: SEE "PARKLET DESIGN GUIDELINES" FOR OTHER REQUIREMENTS.

NO.	REVISED	BY	APP.

DWN: CLG  
CHK JT  
DEC 2021

CITY OF ALAMEDA, CALIFORNIA, PUBLIC WORKS DEPARTMENT

## PARKLET BARRICADE DETAIL

DATE 12/07/21

STD DETAIL

# ST 17-1

PAGE 1 OF 1

SCALE: NONE

Images: Alameda.png; Xrefs: Path: F:\BMAP-STD\Alameda\Std\2021 Std Update\ST 17-2.dwg Layout Name: ST 17-2 Plot Date: Dec 07, 2021 at 13:53

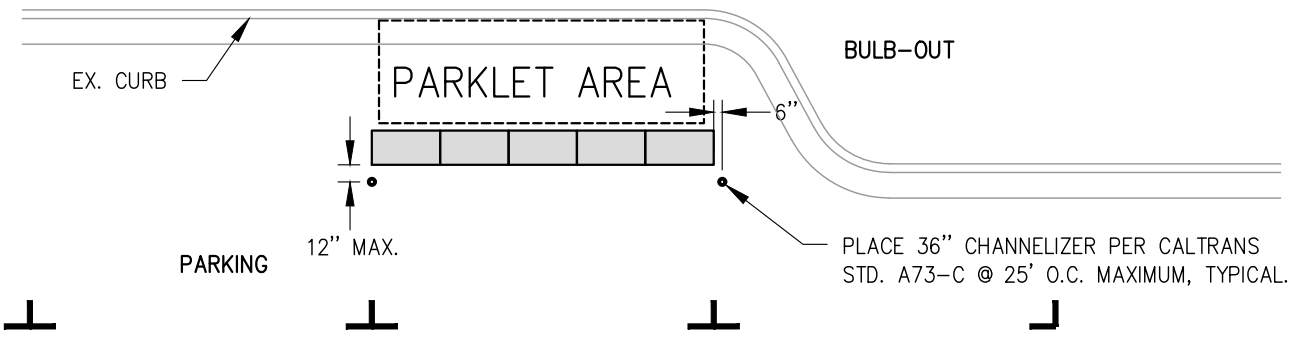

CASE 1

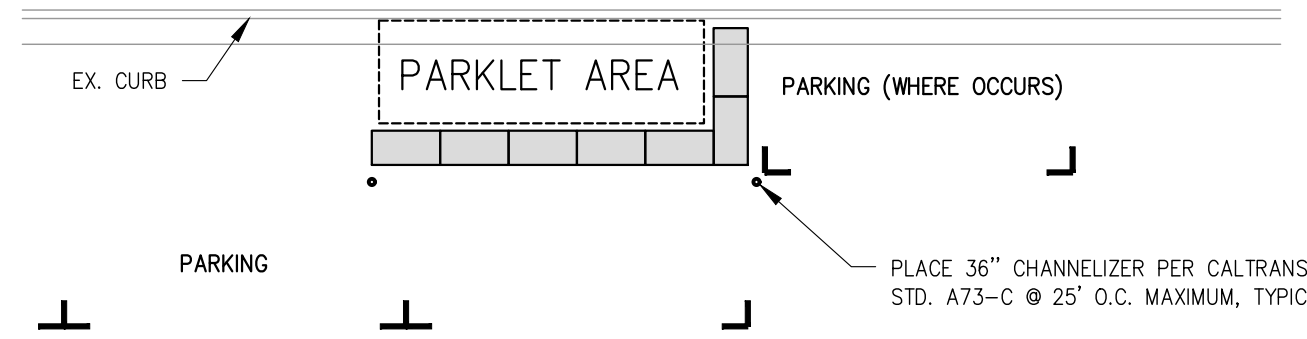

CASE 2

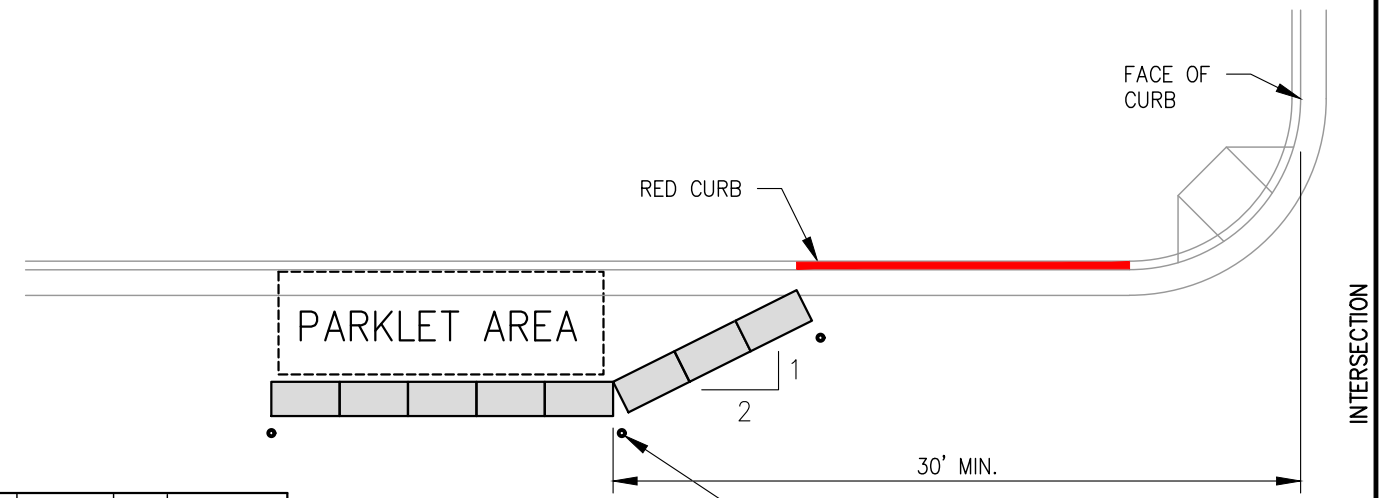

CASE 3

NO.	REVISED	BY	APP.

	DWN: CLG
	CHK JT
	DEC 2021

CITY OF ALAMEDA, CALIFORNIA, PUBLIC WORKS DEPARTMENT

**PARKLET BARRICADE DETAIL**

DATE 12/07/21

STD DETAIL

**ST 17-2**

PAGE 1 OF 1

SCALE: NONE